



# User Manual

## 4G IloT Gateway

DOM-530-TSO

# 4G IIoT Gateway

---

Chapter 1 Introduction .....	6
1.1 Introduction .....	6
1.2 Contents List .....	7
1.2.1 Package Contents .....	7
1.3 Hardware Configuration.....	8
1.4 LED Indication.....	10
1.5 Installation & Maintenance Notice.....	11
1.5.1 SYSTEM REQUIREMENTS.....	11
1.5.2 WARNING.....	11
1.5.3 HOT SURFACE CAUTION .....	13
1.6 Hardware Installation .....	14
1.6.1 Mount the Unit.....	14
1.6.2 Insert the SIM Card .....	14
1.6.3 Connecting Power .....	15
1.6.4 Connecting DI/DO Devices.....	16
1.6.5 Connecting Serial Devices.....	17
1.6.6 Connecting to the Network or a Host .....	17
1.6.7 Setup by Configuring WEB UI.....	18
Chapter 2 Basic Network .....	19
2.1 WAN & Uplink .....	19
2.1.1 Physical Interface.....	20
2.1.2 Internet Setup.....	25
2.2 LAN & VLAN.....	45
2.2.1 Ethernet LAN .....	45
2.2.2 VLAN .....	48
2.2.3 DHCP Server.....	61
2.3 IPv6.....	69
2.3.1 IPv6 Configuration.....	69
2.4 Port Forwarding .....	76
2.4.1 Configuration.....	77
2.4.2 Virtual Server & Virtual Computer.....	78

# 4G IIoT Gateway

---

2.4.3 DMZ & Pass Through.....	84
2.4.4 Special AP & ALG (not supported).....	86
2.5 Routing.....	87
2.5.1 Static Routing.....	88
2.5.2 Dynamic Routing.....	91
2.5.3 Routing Information .....	99
2.6 DNS & DDNS.....	100
2.6.1 DNS & DDNS Configuration .....	100
Chapter 3 Object Definition .....	104
3.1 Scheduling.....	104
3.1.1 Scheduling Configuration.....	104
3.2 Grouping.....	106
3.2.1 Host Grouping .....	106
3.3 External Server.....	108
3.4 Certificate .....	111
3.4.1 Configuration.....	111
3.4.2 My Certificate.....	114
3.4.3 Trusted Certificate .....	121
3.4.4 Issue Certificate.....	127
Chapter 4 Field Communication .....	130
4.1 Bus & Protocol .....	130
4.1.1 Port Configuration.....	130
4.1.2 Virtual COM.....	132
4.1.3 Modbus.....	142
4.2 Data Logging.....	153
4.2.1 Data Logging Configuration.....	156
4.2.2 Scheme Setup.....	158
4.2.3 Log File Management.....	160
Chapter 5 Security.....	162
5.1 VPN.....	162
5.1.1 IPSec.....	163

# 4G IIoT Gateway

---

5.1.2	OpenVPN.....	177
5.1.3	L2TP .....	190
5.1.4	PPTP .....	198
5.1.5	GRE.....	205
5.2	Firewall .....	209
5.2.1	Packet Filter .....	209
5.2.2	MAC Control.....	214
5.2.3	IPS .....	217
5.2.4	Options .....	221
Chapter 6	Administration .....	225
6.1	Configure & Manage .....	225
6.1.1	Command Script.....	226
6.1.2	D-ECS.....	230
6.1.3	SNMP .....	232
6.1.4	Telnet & SSH .....	243
6.2	System Operation.....	247
6.2.1	Password & MMI.....	247
6.2.2	System Information .....	251
6.2.3	System Time.....	252
6.2.4	System Log .....	257
6.2.5	Backup & Restore .....	262
6.2.6	Reboot & Reset .....	263
6.3	FTP .....	264
6.3.1	Server Configuration .....	265
6.3.2	User Account.....	267
6.4	Diagnostic .....	268
6.4.1	Diagnostic Tools .....	268
6.4.2	Packet Analyzer .....	269
Chapter 7	Service.....	272
7.1	Cellular Toolkit.....	272
7.1.1	Data Usage .....	273

# 4G IIoT Gateway

---

7.1.2 SMS.....	276
7.1.3 SIM PIN.....	280
7.1.4 USSD .....	284
7.1.5 Network Scan .....	287
7.2 SMS & Event.....	289
7.2.1 Configuration.....	291
7.2.2 Managing Events.....	301
7.2.3 Notifying Events.....	304
7.3 Location Tracking .....	307
7.3.1 GNSS .....	308
Chapter 8 Status .....	314
8.1 Dashboard.....	314
8.1.1 Device Dashboard .....	314
8.2 Basic Network.....	316
8.2.1 WAN & Uplink Status.....	316
8.2.2 LAN & VLAN Status.....	320
8.2.3 DDNS Status.....	321
8.3 Security.....	322
8.3.1 VPN Status .....	322
8.3.2 Firewall Status .....	326
8.4 Administration .....	329
8.4.1 Configure & Manage Status.....	329
8.4.2 Log Storage Status .....	330
8.4.3 GNSS Status.....	331
8.5 Statistics & Report.....	332
8.5.1 Connection Session .....	332
8.5.2 Network Traffic.....	333
8.5.3 Device Administration.....	334
8.5.4 Cellular Usage .....	335

## Chapter 1 Introduction

### 1.1 Introduction

Congratulations on your purchase of this outstanding product: 4G IIoT Gateway. For M2M (Machine-to-Machine) applications, D-Link Cellular Gateway is absolutely the right choice.

With a built-in world-class 4G LTE module, you just need to insert SIM card from local mobile carrier to get to Internet. The dual SIM design provides a more reliable WAN connection for critical applications. By VPN tunneling technology, remote sites easily become a part of Intranet, and all data are transmitted in a secure (256-bit AES encryption) link. The feature of DI/DO allows gateway to have real-time response whenever events are detected by sensors.

This product is loaded with luxuriant security features including VPN, firewall, NAT, port forwarding, DHCP server and many other powerful features for outdoor IP surveillance applications. The redundancy design in dual SIM cards make the data transmission and network connection without lost.

Main Features:

- Built-in high speed LTE modem with dual SIMs for uplink traffic failover.
- Equip gigabit Ethernet ports to connect other IP-based devices.
- RS232/485 serial ports for controlling legacy serial devices or Modbus devices.
- Digital I/O ports for integrating sensors, switch, or other alarm devices.
- Designed by solid and easy-to-mount metal body for industrial environment to work with a variety M2M (Machine-to-Machine) applications.









Before you install and use this product, please read this manual in detail for fully exploiting the functions of this product.

# 4G IIoT Gateway

## 1.2 Contents List

### 1.2.1 Package Contents

#### #Standard Package

Items	Description	Contents	Quantity
1	DOM-530-TSO 4G IIoT Gateway		1pcs
2	Cellular Antenna		2pcs
3	Power Adapter (DC 12V/2A) (*1)		1pcs
4	RJ45 Cable		1pcs
5	2 pin Terminal Block		1pcs
6	4 pin Terminal Block		1pcs
7	6 pin Terminal Block		1pcs
8	4 PCS Rubber feet		1pcs
9	DIN-Rail Bracket		1pcs

1 The maximum power consumption of DOM-530-TSO is 10W.

# 4G IIoT Gateway

## 1.3 Hardware Configuration

### ➤ Front View

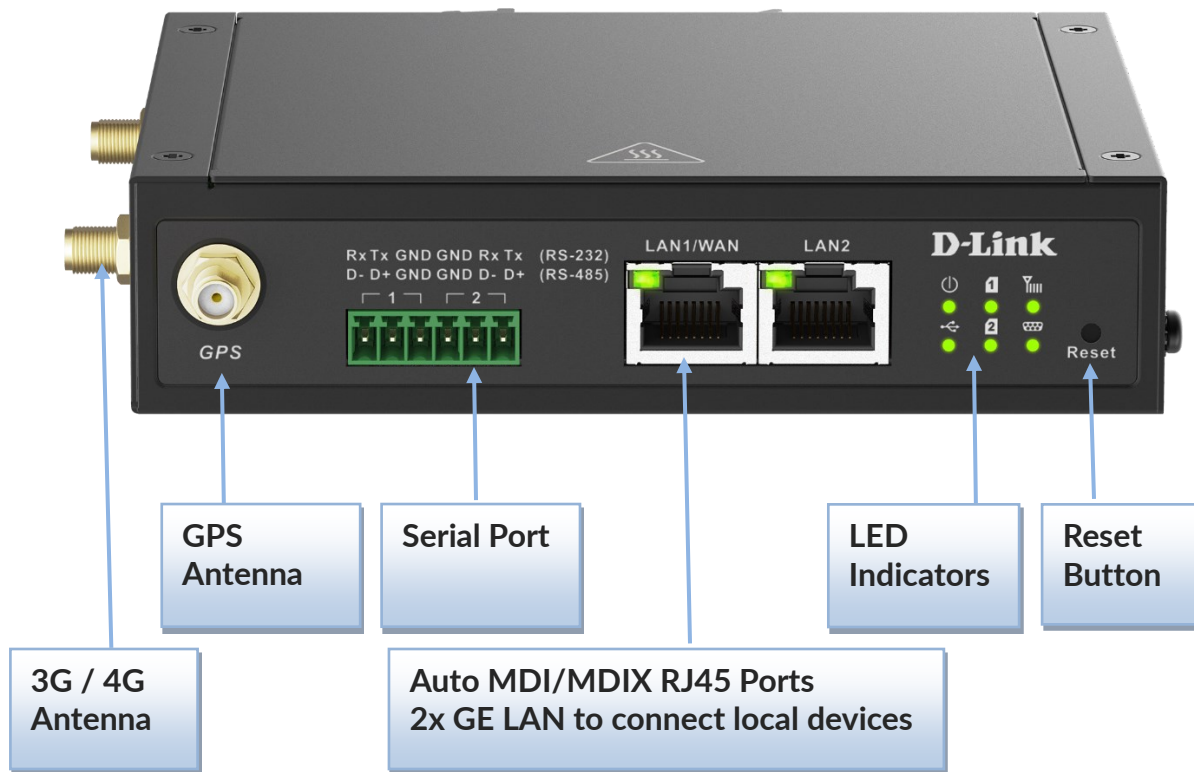

#### ⌘ Reset Button

The RESET button provides user with a quick and easy way to resort the default setting. Press the RESET button continuously for 20 seconds, and then release it. The device will restore to factory default settings.

#### ⌘ GPS Antenna

**The GNSS function is not available for some specific SKU. Even for the SKU with GNSS enabled, the GPS Antenna is an optional accessory, and not included in the standard package.** If you intend to use the provided GNSS function, please purchase additional passive-type GPS antenna and install it to the corresponding SMA connector in advance.

# 4G IIoT Gateway

## ➤ Bottom View

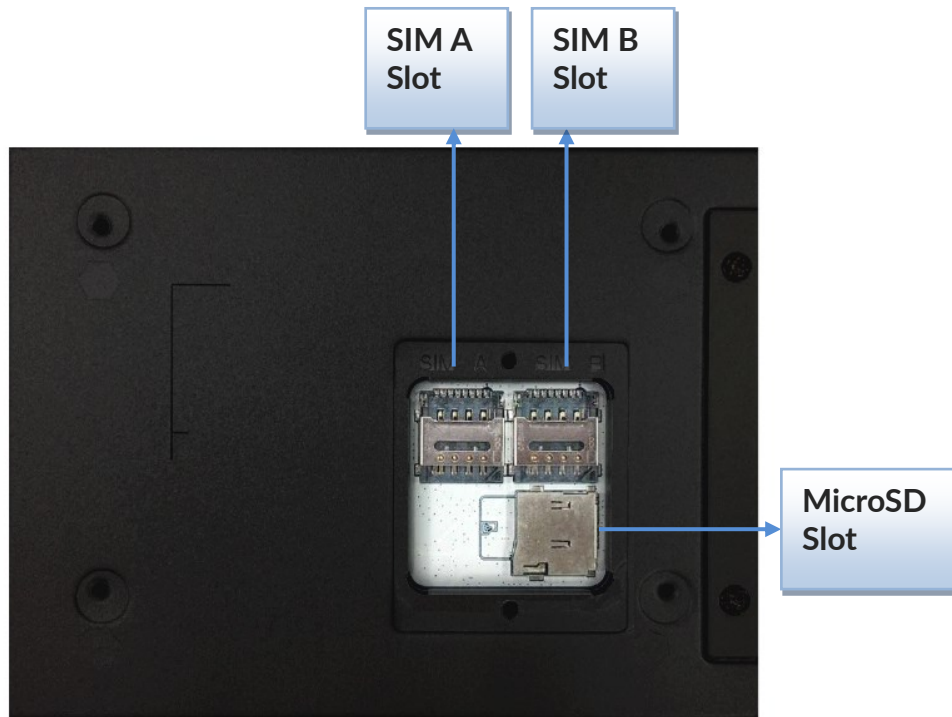



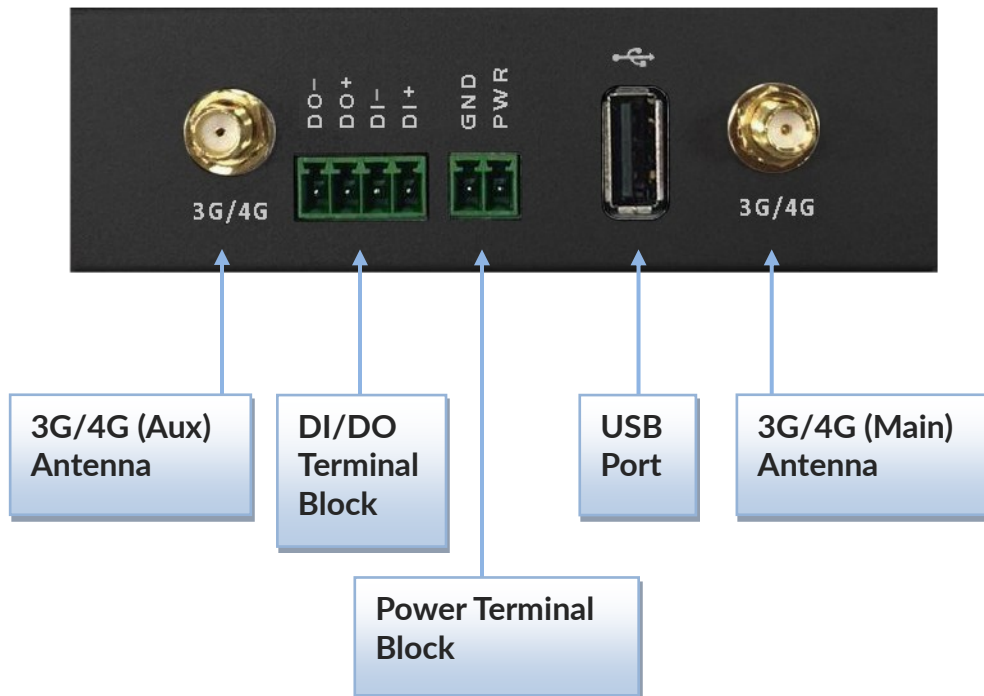



## ➤ Left View



# 4G IIoT Gateway

## 1.4 LED Indication



LED Icon	Indication	LED Color	Description
	Power Source	Blue	<b>Steady ON:</b> Device is powered ON.
	USB	Blue	<b>OFF :</b> No Serial data transferred via USB port <b>In Flashing :</b> while data packet transferred via USB port
	SIM A/B	Blue	<b>OFF :</b> SIM doesn't detect <b>Slow Flash(per Second) :</b> SIM A/B was chosen to do the connection <b>Steady ON :</b> Cellular connection already established successful (under SIM A/B)
	Cellular Signal	Blue	<b>Steady On :</b> Signal Strength is 61~100% <b>Slow Flash(per Second) :</b> Signal Strength is 31~60% <b>Fast Flash(per 0.5 second) :</b> Signal Strength is 0~30% <b>Very Fast Flash :</b> Device is in Recovery mode, or abnormal.
	Serial	Blue	<b>OFF :</b> No Serial data transferred via serial port <b>In Flashing :</b> while data packet transferred via Serial port
	WAN/LAN1 ~ LAN 2	Green	<b>Steady ON:</b> Ethernet connection of LAN or WAN is established. <b>Flash:</b> Data packets are transferring. <b>OFF:</b> No Ethernet cable attached, or Device not linked.

# 4G IIoT Gateway

## 1.5 Installation & Maintenance Notice

### 1.5.1 SYSTEM REQUIREMENTS

Network Requirements	<ul style="list-style-type: none"><li>• An gigabit Ethernet RJ45 cable</li><li>• 3G/4G cellular service subscription</li><li>• 10/100/1000 Ethernet adapter on PC</li></ul>
Web-based Configuration Utility Requirements	<p><b>Computer with the following:</b></p> <ul style="list-style-type: none"><li>• Windows®, Macintosh, or Linux-based operating system</li><li>• An installed Ethernet adapter</li></ul> <p><b>Browser Requirements:</b></p> <ul style="list-style-type: none"><li>• Internet Explorer 6.0 or higher</li><li>• Chrome 2.0 or higher</li><li>• Firefox 3.0 or higher</li><li>• Safari 3.0 or higher</li></ul>

### 1.5.2 WARNING



**Attention**

- Only use the power supply that complies with the power specification of the gateway. Using an out-of-spec voltage rating power source is dangerous and may damage the product.
- Do not open or repair the case yourself. If the product is too hot, turn off the power immediately and have it repaired at a qualified service center.

# 4G IIoT Gateway

---

## **Federal Communication Commission Interference Statement**

This device complies with Part 15 of the FCC Rules. Operation is subject to the following two conditions: (1) This device may not cause harmful interference, and (2) this device must accept any interference received, including interference that may cause undesired operation.

This equipment has been tested and found to comply with the limits for a Class B digital device, pursuant to Part 15 of the FCC Rules. These limits are designed to provide reasonable protection against harmful interference in a residential installation. This equipment generates, uses and can radiate radio frequency energy and, if not installed and used in accordance with the instructions, may cause harmful interference to radio communications. However, there is no guarantee that interference will not occur in a particular installation. If this equipment does cause harmful interference to radio or television reception, which can be determined by turning the equipment off and on, the user is encouraged to try to correct the interference by one of the following measures:

- Reorient or relocate the receiving antenna.
- Increase the separation between the equipment and receiver.
- Connect the equipment into an outlet on a circuit different from that to which the receiver is connected.
- Consult the dealer or an experienced radio/TV technician for help.

FCC Caution: Any changes or modifications not expressly approved by the party responsible for compliance could void the user's authority to operate this equipment.

This transmitter must not be co-located or operating in conjunction with any other antenna or transmitter.

## **FOR PORTABLE DEVICE USAGE (<20m from body/SAR needed)**

### **Radiation Exposure Statement:**

The product comply with the FCC portable RF exposure limit set forth for an uncontrolled environment and are safe for intended operation as described in this manual. The further RF exposure reduction can be achieved if the product can be kept as far as possible from the user body or set the device to lower output power if such function is available.

## **FOR MOBILE DEVICE USAGE (>20cm/low power)**

### **Radiation Exposure Statement:**

This equipment complies with FCC radiation exposure limits set forth for an uncontrolled environment. This equipment should be installed and operated with minimum distance 20cm between the radiator & your body.

## **FOR COUNTRY CODE SELECTION USAGE (WLAN DEVICES)**

Note: The country code selection is for non-US model only and is not available to all US model. Per FCC regulation, all WiFi product marketed in US must fixed to US operation channels only.

### 1.5.3 HOT SURFACE CAUTION



**CAUTION:** The surface temperature for the metallic enclosure can be very high! Especially after operating for a long time, installed at a closed cabinet without air conditioning support, or in a high ambient temperature space.

**DO NOT touch the hot surface with your fingers while servicing!!**

# 4G IIoT Gateway

## 1.6 Hardware Installation

This chapter describes how to install and configure the hardware

### 1.6.1 Mount the Unit

The product can be mounted on a wall, horizontal plane, or DIN Rail in a cabinet with the mounting accessories (brackets or DIN-rail kit). The mounting accessories are not screwed on the product when out of factory. Please screw the wall-mount kits or DIN-rail bracket on the product first.

### 1.6.2 Insert the SIM Card

**WARNING: BEFORE INSERTING OR CHANGING THE SIM CARD, PLEASE MAKE SURE THAT POWER OF THE DEVICE IS SWITCHED OFF.**

The SIM card slots are located at the bottom side of the housing. You need to unscrew and remove the outer SIM card cover before installing or removing the SIM card. Please follow the instructions to insert a SIM card. After SIM card is well placed, screw back the outer SIM card cover.

**Step 1:**  
Pull the SIM holder as the RED direction to unlock SIM holder

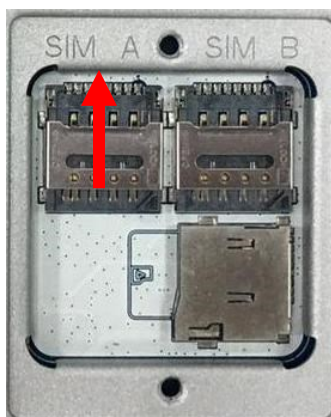

**Step 2:**  
Lift up SIM holder, and insert SIM card

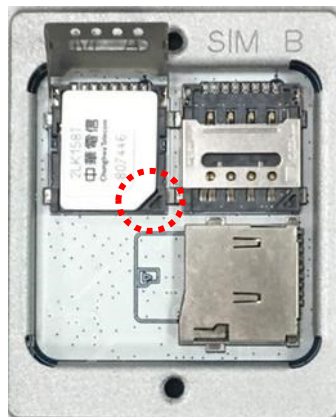

**Step 3:**  
Put back SIM holder, and pull it in the RED direction to lock SIM



# 4G IIoT Gateway

## 1.6.3 Connecting Power

The product can be powered by connecting DC power sources to the terminal block. **It supports 9 to 36V DC power input.** Following picture indicates the power terminal block pin assignments. Please check carefully and connect to the right power requirements and polarity.



There is a DC12V/2A power adapter<sup>2</sup> in the package for you to easily connect DC power adapter to this terminal block.



**WARNING: This commercial-grade power adapter is mainly for ease of powering up the purchased device while initial configuration. It's not for operating at wide temperature range environment. PLEASE PREPARE OR PURCHASE OTHER INDUSTRIAL-GRADE POWER SUPPLY FOR POWERING UP THE DEVICE.**

<sup>2</sup> The maximum power consumption of DOM-530-TSO is 10W.

# 4G IIoT Gateway

## 1.6.4 Connecting DI/DO Devices

There are one DI and one DO ports together with power terminal block. Please refer to following specification to connect DI and DO devices.



DO-  
DO+  
DI-  
DI+

Mode	Specification	
Digital Input	Trigger Voltage (high)	Logic level 1: 5V~30V
	Normal Voltage (low)	Logic level 0: 0V~2V
Digital Output	Voltage (Relay Mode)	Depends on external device maximum voltage is 30V
	Maximum Current	1A

### Example of Connection Diagram

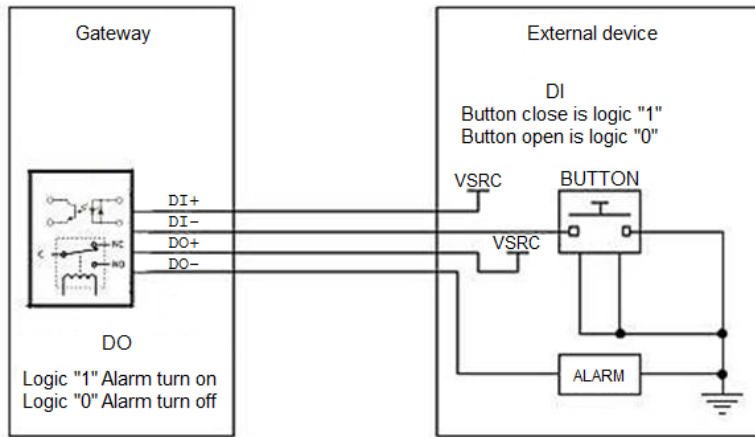

# 4G IIoT Gateway

## 1.6.5 Connecting Serial Devices

The product provides 6-pin Terminal Block serial port for connecting to your serial device. Connect the serial device to the terminal block with the right pin assignments of RS-232/485 are shown as below.



Pin 1 2 3 4 5 6

	Pin1	Pin2	Pin3	Pin4	Pin5	Pin6
Port	SPort-0			SPort-1		
RS-232	RXD	TXD	GND	GND	RXD	TXD
RS-485	DATA-	DATA+	GND	GND	DATA-	DATA+

## 1.6.6 Connecting to the Network or a Host

The product provides RJ45 ports to connect 10/100/1000Mbps Ethernet. It can auto detect the transmission speed on the network and configure itself automatically. Connect one Ethernet cable to the RJ45 port (LAN) of the device and plug another end of the Ethernet cable into your computer's network port. In this way, you can use the RJ45 Ethernet cable to connect to the host PC's Ethernet port for configuring the device.

# 4G IloT Gateway

## 1.6.7 Setup by Configuring WEB UI

You can browse web UI to configure the device.

Type in the IP Address (<http://192.168.0.1>) The default LAN IP address of this gateway is 192.168.0.1. If you change it, you need to login by using the new IP address.

When you see the login page, enter the user name and password and then click 'Login' button. The default setting for both username and password is 'admin'.



Welcome to the device's configuration UI.  
Enter your Username & Password, then click 'Login'.

**D-Link**

Username

Password

Login

For the security purposes, you will be asked to change the log-in password when logging in for the first time.

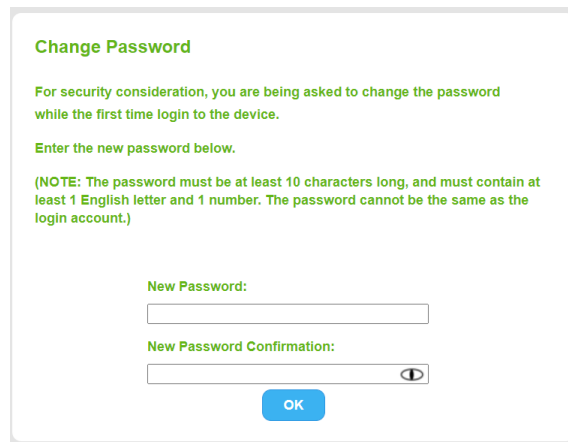

**Change Password**

For security consideration, you are being asked to change the password while the first time login to the device.

Enter the new password below.

(NOTE: The password must be at least 10 characters long, and must contain at least 1 English letter and 1 number. The password cannot be the same as the login account.)

New Password:

New Password Confirmation:

OK

After that, you will be asked to log in again with the new password.

**Note 1:** Keep the log-in password properly for further device configuration.

**Note 2:** If you lose or forget the log-in password, the ONLY remedy is to recover the device to its factory default settings via long-pressing the Reset button.

**Note 3:** In this situation, your device configuration will be erased. In addition to keeping the log-in password, you may have to backup the device configuration and keep it safely for future use.

## Chapter 2 Basic Network

### 2.1 WAN & Uplink

The gateway provides multiple WAN interfaces to let all client hosts in Intranet of the gateway access the Internet via ISP. But ISPs in the world apply various connection protocols to let gateways or user's devices dial in ISPs and then link to the Internet via different kinds of transmit media.

So, the WAN Connection lets you specify the WAN Physical Interface, WAN Internet Setup and WAN Load Balance for Intranet to access Internet. For each WAN interface, you must specify its physical interface first and then its Internet setup to connect to ISP. Besides, since the gateway has multiple WAN interfaces, you can assign physical interface to participate in the Load Balance function.

# 4G IIoT Gateway

## 2.1.1 Physical Interface

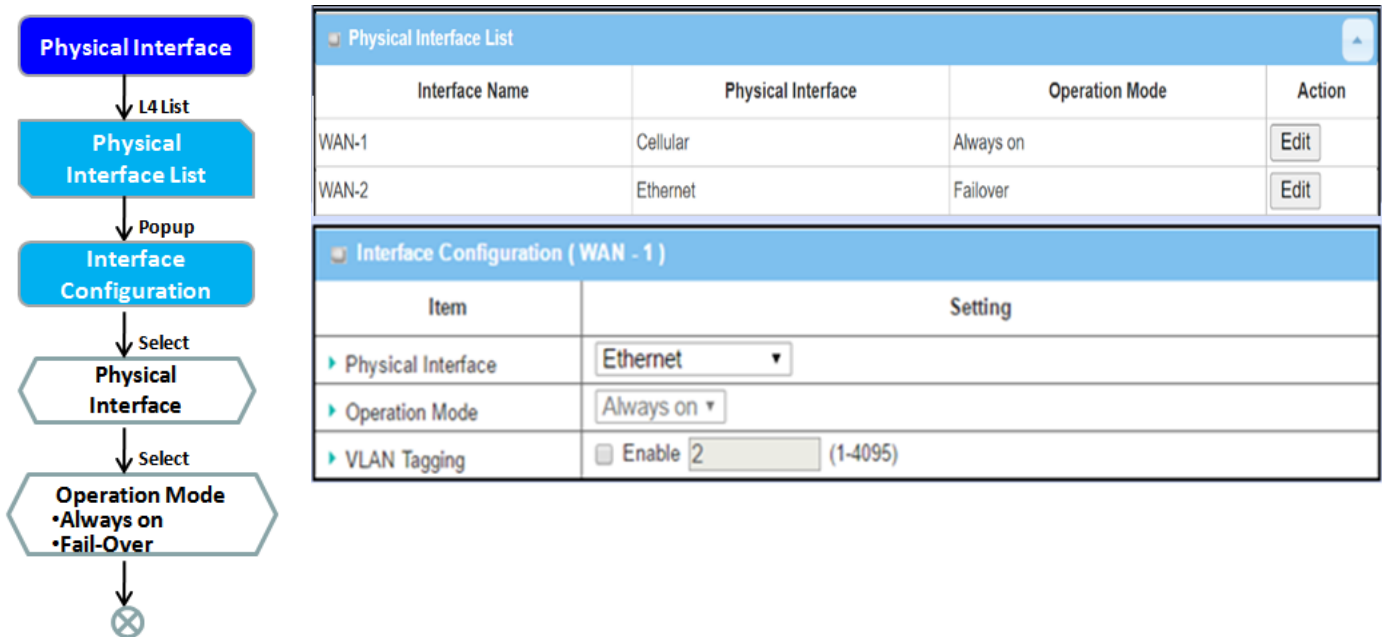

M2M gateways are usually equipped with various WAN interfaces to support different WAN connection scenario for requirement. You can configure the WAN interface one by one to get proper internet connection setup. **Refer to the product specification for the available WAN interfaces in the product you purchased.**

The first step to configure one WAN interface is to specify which kind of connection media to be used for the WAN connection, as shown in "Physical Interface" page.

In "Physical Interface" page, there are two configuration windows, "Physical Interface List" and "Interface Configuration". "Physical Interface List" window shows all the available physical interfaces. After clicking on the "Edit" button for the interface in "Physical Interface List" window the "Interface Configuration" window will appear to let you configure a WAN interface.

### **Physical Interface:**

- **Ethernet WAN:** The gateway has one or more RJ45 WAN ports that can be configured to be WAN connections. You can directly connect to external DSL modem or setup behind a firewall device.
- **3G/4G WAN:** The gateway has one built-in 3G/4G cellular as WAN connection. For each cellular WAN, there are 1 or 2 SIM cards to be inserted for special failover function.

# 4G IIoT Gateway



- Please **MUST POWER OFF** the gateway before you insert or remove SIM card.
- The SIM card can be damaged if you insert or remove SIM card while the gateway is in

## Operation Mode:

There are three option items "Always on", "Failover", and "Disable" for the operation mode setting.

**Always on:** Set this WAN interface to be active all the time. When two or more WAN are established at "Always on" mode, outgoing data will through these WAN connections base on load balance policies.

## Failover:

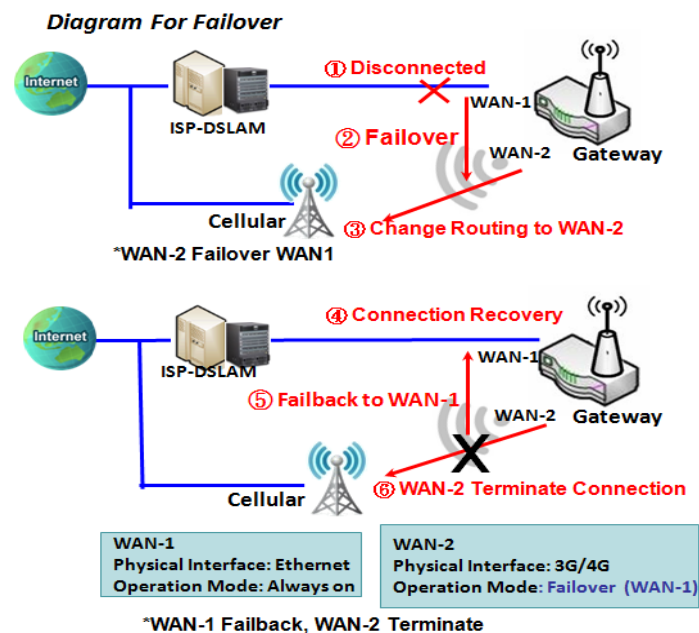

A failover interface is a backup connection to the primary. That means only when its primary WAN connection is broken, the backup connection will be started up to substitute the primary connection. As shown in the diagram, WAN-2 is backup WAN for WAN-1. WAN-1 serves as the primary connection with operation mode "Always on". WAN-2 won't be activated until WAN-1 disconnected. When WAN-1 connection is recovered back with a connection, it will take over data traffic again. At that time, WAN-2 connection will be terminated.

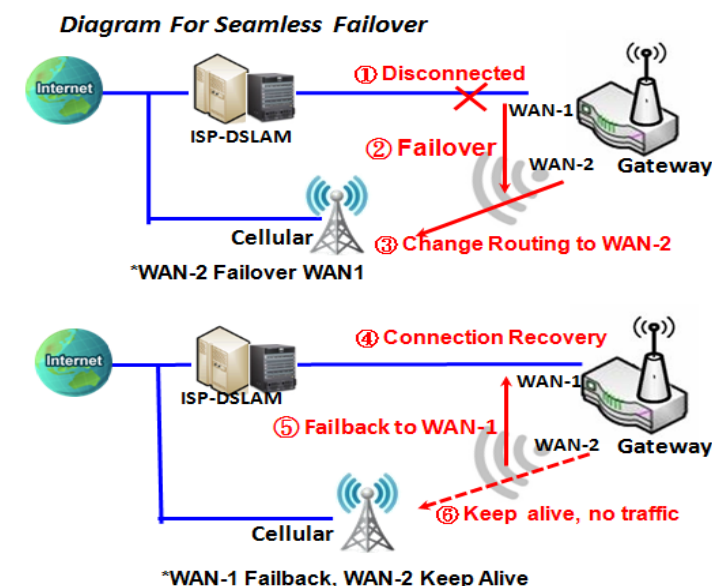

## Seamless Failover:

In addition, there is a "Seamless" option for Failover operation mode. When seamless option is activated by checking on the "Seamless" box in configuration window, both the primary connection and the failover connection are started up after system rebooting. But only the primary connection executes the data transfer, while the failover one just keeps alive of connection line. As soon as the primary connection is broken, the system will switch,

## 4G IloT Gateway

---

meaning failover, the routing path to the failover connection to save the dial up time of failover connection since it has been alive.

When the “Seamless” enable checkbox is activated, it can allow the Failover interface to be connected continuously from system booting up. Failover WAN interface just keeps connecting without data traffic. The purpose is to shorten the switch time during failover process. So, when primary connection is disconnected, failover interface will take over the data transfer mission instantly by only changing routing path to the failover interface. The dialing-up time of failover connection is saved since it has been connected beforehand.

### **VLAN Tagging**

Sometimes, your ISP required a VLAN tag to be inserted into the WAN packets from Gateway for specific services. Please enable VLAN tagging and specify tag in the WAN physical interface. Please be noted that only Ethernet and ADSL physical interfaces support the feature. For the device with 3G/4G WAN only, it is disabled.

# 4G IIoT Gateway

## Physical Interface Setting

Go to **Basic Network > WAN > Physical Interface** tab.

The Physical Interface allows user to setup the physical WAN interface and to adjust WAN's behavior.

Note: Numbers of available WAN Interfaces can be different for the purchased gateway.

Physical Interface List			
Interface Name	Physical Interface	Operation Mode	Action
WAN-1	Ethernet	Always on	<input type="button" value="Edit"/>
WAN-2	3G/4G	Always on	<input type="button" value="Edit"/>

When **Edit** button is applied, an **Interface Configuration** screen will appear. WAN-1 interface is used in this example.

### Interface Configuration:

Interface Configuration ( WAN - 1 )	
Item	Setting
▶ Physical Interface	<input type="text" value="Ethernet"/>
▶ Operation Mode	<input type="text" value="Always on"/>
▶ VLAN Tagging	<input type="checkbox"/> Enable <input type="text" value="2"/> (1-4095)

Interface Configuration		
Item	Value setting	Description
<b>Physical Interface</b>	1. A Must fill setting 2. WAN-1 is the primary interface and is factory set to Always on.	Select one expected interface from the available interface dropdown list. Depending on the gateway model, <b>Disable</b> and <b>Failover</b> options will be available only to multiple WAN gateways. WAN-2 ~ WAN-4 interfaces are only available to multiple WAN gateway.
<b>Operation Mode</b>	A Must fill setting	Define the operation mode of the interface. Select <b>Always on</b> to make this WAN always active. Select <b>Disable</b> to disable this WAN interface. Select <b>Failover</b> to make this WAN a Failover WAN when the primary or the

## 4G IloT Gateway

---

		<p>secondary WAN link failed. Then select the primary or the existed secondary WAN interface to switch Failover from.</p> <p>(Note: for WAN-1, only <b>Always on</b> option is available.)</p>
<b>VLAN Tagging</b>	Optional setting	<p>Check <b>Enable</b> box to enter tag value provided by your ISP. Otherwise uncheck the box.</p> <p><b><u>Value Range:</u> 1 ~ 4095.</b></p> <p>Note: This feature is NOT available for 3G/4G WAN connection.</p>

# 4G IIoT Gateway

## 2.1.2 Internet Setup

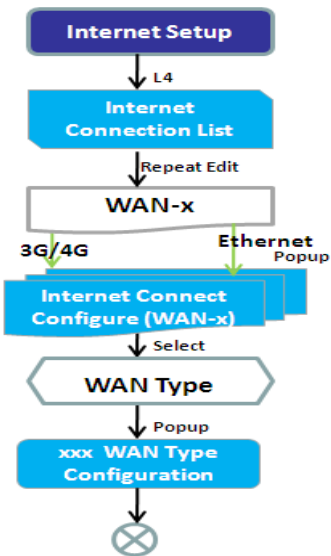

Internet Connection List				
Interface Name	Physical Interface	Operation Mode	WAN Type	Action
WAN-1	Ethernet	Always on	Dynamic IP	<input type="button" value="Edit"/>
WAN-2	3G/4G	Always on	3G/4G	<input type="button" value="Edit"/>

Internet Connection Configuration ( WAN - 1 )	
Item	Setting
▶ WAN Type	<input type="text" value="Dynamic IP"/>

Dynamic IP WAN Type Configuration	
Item	Setting
▶ Host Name	<input type="text"/> (Optional)
▶ ISP Registered MAC Address	<input type="text"/> <input type="button" value="Clone"/> (Optional)
▶ Connection Control	<input type="text" value="Auto-reconnect"/>
▶ MTU	<input type="text" value="0"/> (0 is Auto)
▶ NAT	<input checked="" type="checkbox"/> Enable

After specifying the physical interface for each WAN connection, administrator must configure their connection profile to meet the dial in process of ISP, so that all client hosts in the Intranet of the gateway can access the Internet.

In "Internet Setup" page, there are some configuration windows: "Internet Connection List", "Internet Connection Configuration", "WAN Type Configuration" and related configuration windows for each WAN type. For the Internet setup of each WAN interface, you must specify its WAN type of physical interface first and then its related parameter configuration for that WAN type.

After clicking on the "Edit" button of a physical interface in "Internet Setup List" window, the "Internet Connection Configuration" window will appear to let you specify which kind of WAN type that you will use for that physical interface to make an Internet connection. Based on your chosen WAN type, you can configure necessary parameters in each corresponding configuration window.

# 4G IIoT Gateway

## Internet Connection List - Ethernet WAN

Item	Setting
WAN Type	Dynamic IP ▼
Dynamic IP WAN Type Configuration	
Item	Setting
Host Name	(Optional)
ISP Registered MAC Address	Clone (Optional)
Connection Control	Auto-reconnect (Always on) ▼
MTU	0 (0 is Auto)
NAT	<input checked="" type="checkbox"/> Enable
	<input checked="" type="checkbox"/> Enable <input checked="" type="radio"/> DNS Query <input type="radio"/> ICMP Checking <input checked="" type="checkbox"/> Loading Check Check Interval 5 (seconds) Check Timeout 3 (seconds) Latency 2000 (ms)
Network Monitoring	

### WAN Type for Ethernet Interface:

Ethernet is the most common WAN and uplink interface for M2M gateways. Usually it is connected with xDSL or cable modem for you to setup the WAN connection. There are various WAN types to connect with ISP.

- **Static IP:** Select this option if ISP provides a fixed IP to you when you subscribe the service. Usually is more expensive but very important for cooperate requirement.
- **Dynamic IP:** The assigned IP address for the WAN by a DHCP server is different every time. It is cheaper and usually for consumer use.
- **PPP over Ethernet:** As known as PPPoE. This WAN type is widely used for ADSL connection. IP is usually different for every dial up.
- **PPTP:** This WAN type is popular in some countries, like Russia.
- **L2TP :** This WAN type is popular in some countries, like Israel.

### Configure Ethernet WAN Setting

When **Edit** button is applied, **Internet Connection Configuration** screen will appear. WAN-1 interface is used in this example.

# 4G IIoT Gateway

## WAN Type = Dynamic IP

Internet Connection Configuration ( WAN - 1 )	
Item	Setting
▶ WAN Type	Dynamic IP ▼

When you select it, "Dynamic IP WAN Type Configuration" will appear. Items and setting is explained below

Dynamic IP WAN Type Configuration	
Item	Setting
▶ Host Name	<input type="text"/> (Optional)
▶ ISP Registered MAC Address	<input type="text"/> <input type="button" value="Clone"/> (Optional)

Dynamic IP WAN Type Configuration		
Item	Value setting	Description
Host Name	An optional setting	Enter the host name provided by your Service Provider.
ISP Registered MAC Address	An optional setting	Enter the MAC address that you have registered with your service provider. Or Click the <b>Clone</b> button to clone your PC's MAC to this field. Usually this is the PC's MAC address assigned to allow you to connect to Internet.

## WAN Type= Static IP

Internet Connection Configuration ( WAN - 1 )	
Item	Setting
▶ WAN Type	Static IP ▼

When you select it, "Static IP WAN Type Configuration" will appear. Items and setting is explained below

Static IP WAN Type Configuration	
Item	Setting
▶ WAN IP Address	<input type="text"/>
▶ WAN Subnet Mask	255.255.255.0 (/24) ▼
▶ WAN Gateway	<input type="text"/>
▶ Primary DNS	<input type="text"/>
▶ Secondary DNS	<input type="text"/> (Optional)

# 4G IIoT Gateway

Static IP WAN Type Configuration		
Item	Value setting	Description
<b>WAN IP Address</b>	A Must filled setting	Enter the WAN IP address given by your Service Provider
<b>WAN Subnet Mask</b>	A Must filled setting	Enter the WAN subnet mask given by your Service Provider
<b>WAN Gateway</b>	A Must filled setting	Enter the WAN gateway IP address given by your Service Provider
<b>Primary DNS</b>	A Must filled setting	Enter the primary WAN DNS IP address given by your Service Provider
<b>Secondary DNS</b>	An optional setting	Enter the secondary WAN DNS IP address given by your Service Provider

## WAN Type= PPPoE

Internet Connection Configuration ( WAN - 1 )	
Item	Setting
▶ WAN Type	PPPoE ▼

When you select it, "PPPoE WAN Type Configuration" will appear. Items and setting is explained below

PPPoE WAN Type Configuration	
Item	Setting
▶ IPv6 Dual Stack	<input type="checkbox"/> Enable
▶ PPPoE Account	<input type="text"/>
▶ PPPoE Password	<input type="text"/>
▶ Primary DNS	<input type="text"/> (Optional)
▶ Secondary DNS	<input type="text"/> (Optional)
▶ Service Name	<input type="text"/> (Optional)
▶ Assigned IP Address	<input type="text"/> (Optional)

PPPoE WAN Type Configuration		
Item	Value setting	Description
<b>PPPoE Account</b>	A Must filled setting	Enter the PPPoE User Name provided by your Service Provider.
<b>PPPoE Password</b>	A Must filled setting	Enter the PPPoE password provided by your Service Provider.
<b>Primary DNS</b>	An optional setting	Enter the IP address of Primary DNS server.
<b>Secondary DNS</b>	An optional setting	Enter the IP address of Secondary DNS server.
<b>Service Name</b>	An optional setting	Enter the service name if your ISP requires it
<b>Assigned IP Address</b>	An optional setting	Enter the IP address assigned by your Service Provider.

# 4G IIoT Gateway

## WAN Type= PPTP

Internet Connection Configuration ( WAN - 1 )	
Item	Setting
▶ WAN Type	PPTP ▼

When you select it, "PPTP WAN Type Configuration" will appear. Items and setting is explained below

PPTP WAN Type Configuration	
Item	Setting
▶ IP Mode	Dynamic IP Address ▼
▶ Server IP Address / Name	<input type="text"/>
▶ PPTP Account	<input type="text"/>
▶ PPTP Password	<input type="text"/>
▶ Connection ID	<input type="text"/> (Optional)
▶ MPPE	<input type="checkbox"/> Enable

PPTP WAN Type Configuration		
Item	Value setting	Description
IP Mode	A Must filled setting	<p>Select either Static or Dynamic IP address for PPTP Internet connection.</p> <ul style="list-style-type: none"> <li>When <b>Static IP Address</b> is selected, you will need to enter the <b>WAN IP Address, WAN Subnet Mask, and WAN Gateway</b>. <ul style="list-style-type: none"> <li><b>WAN IP Address</b> (A Must filled setting): Enter the WAN IP address given by your Service Provider.</li> <li><b>WAN Subnet Mask</b> (A Must filled setting): Enter the WAN subnet mask given by your Service Provider.</li> <li><b>WAN Gateway</b> (A Must filled setting): Enter the WAN gateway IP address given by your Service Provider.</li> </ul> </li> <li>When <b>Dynamic IP</b> is selected, there are no above settings required.</li> </ul>
Server IP Address/Name	A Must filled setting	Enter the PPTP server name or IP Address.
PPTP Account	A Must filled setting	Enter the PPTP username provided by your Service Provider.
PPTP Password	A Must filled setting	Enter the PPTP connection password provided by your Service Provider.
Connection ID	An optional setting	Enter a name to identify the PPTP connection.
MPPE	An optional setting	Select <b>Enable</b> to enable MPPE (Microsoft Point-to-Point Encryption) security for PPTP connection.

# 4G IIoT Gateway

## WAN Type= L2TP

Internet Connection Configuration ( WAN - 1 )	
Item	Setting
▶ WAN Type	L2TP ▼

When you select it, "L2TP WAN Type Configuration" will appear. Items and setting is explained below

L2TP WAN Type Configuration	
Item	Setting
▶ IP Mode	Dynamic IP Address ▼
▶ Server IP Address / Name	<input type="text"/>
▶ L2TP Account	<input type="text"/>
▶ L2TP Password	<input type="text"/>
▶ Service Port	User-defined ▼ <input type="text" value="1702"/>
▶ MPPE	<input type="checkbox"/> Enable

L2TP WAN Type Configuration		
Item	Value setting	Description
IP Mode	A Must filled setting	<p>Select either Static or Dynamic IP address for L2TP Internet connection.</p> <ul style="list-style-type: none"> <li>When <b>Static IP Address</b> is selected, you will need to enter the <b>WAN IP Address, WAN Subnet Mask, and WAN Gateway</b>. <ul style="list-style-type: none"> <li><b>WAN IP Address</b> (A Must filled setting): Enter the WAN IP address given by your Service Provider.</li> <li><b>WAN Subnet Mask</b> (A Must filled setting): Enter the WAN subnet mask given by your Service Provider.</li> <li><b>WAN Gateway</b> (A Must filled setting): Enter the WAN gateway IP address given by your Service Provider.</li> </ul> </li> <li>When <b>Dynamic IP</b> is selected, there are no above settings required.</li> </ul>
Server IP Address/Name	A Must filled setting	Enter the L2TP server name or IP Address.
L2TP Account	A Must filled setting	Enter the L2TP username provided by your Service Provider.
L2TP Password	A Must filled setting	Enter the L2TP connection password provided by your Service Provider.
Service Port	A Must filled setting	<p>Enter the service port that the Internet service.</p> <p>There are three options can be selected :</p> <ul style="list-style-type: none"> <li><b>Auto</b>: Port will be automatically assigned.</li> <li><b>1701 (For Cisco)</b>: Set service port to port 1701 to connect to CISCO server.</li> <li><b>User-defined</b>: enter a service port provided by your Service Provider.</li> </ul>
MPPE	An optional setting	Select <b>Enable</b> to enable MPPE (Microsoft Point-to-Point Encryption) security for PPTP connection.

# 4G IIoT Gateway

## Ethernet Connection Common Configuration

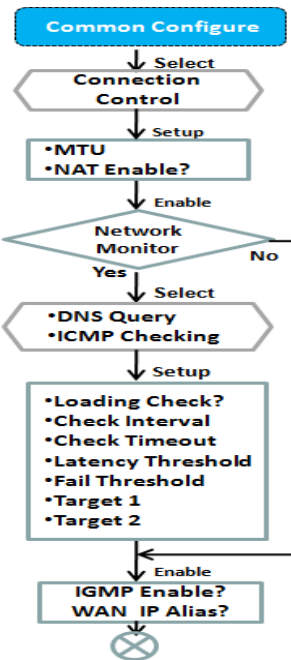

▶ Connection Control	Auto-reconnect ▼
▶ MTU Setup	<input type="checkbox"/> Enable
▶ NAT	<input checked="" type="checkbox"/> Enable
▶ IGMP	Disable ▼
▶ WAN IP Alias	<input type="checkbox"/> Enable 10.0.0.1

Network Monitoring Configuration	
Item	Setting
▶ Network Monitoring Configuration	<input checked="" type="checkbox"/> Enable
▶ Checking Method	DNS Query ▼
▶ Loading Check	<input checked="" type="checkbox"/> Enable
▶ Query Interval	5 (seconds)
▶ Latency Threshold	3000 (ms)
▶ Fail Threshold	5 (Times)
▶ Target1	DNS1 ▼
▶ Target2	None ▼

There are some important parameters to be setup no matter which Ethernet WAN type is selected. You should follow up the rule to configure.

### Connection Control.

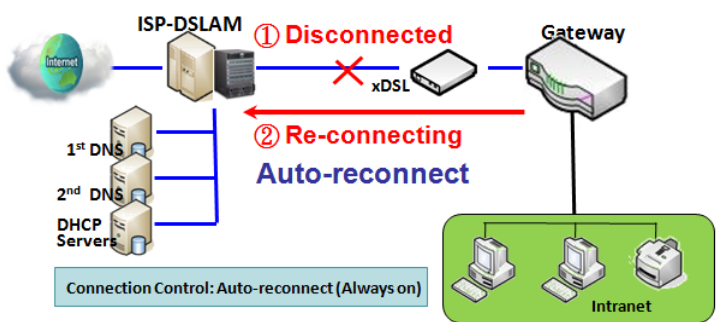

**Auto-reconnect:** This gateway will establish Internet connection automatically once it has been booted up, and try to reconnect once the connection is down. It's recommended to choose this scheme if for mission critical applications to ensure full-time Internet connection.

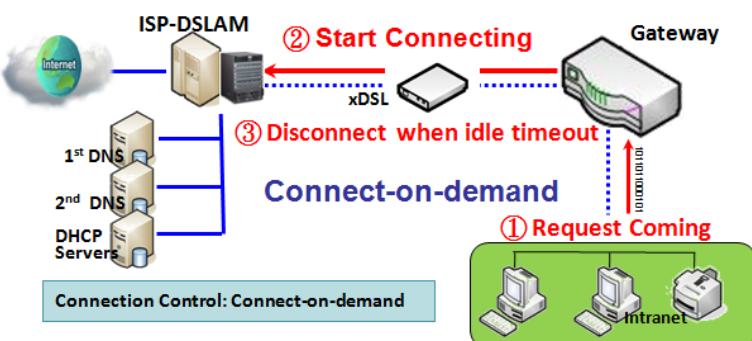

**Connect-on-demand:** This gateway won't start to establish Internet connection until local data is going to be sent to WAN side. After normal data transferring between LAN and WAN sides, this gateway will disconnect WAN connection if idle time reaches value of Maximum Idle Time.

# 4G IIoT Gateway

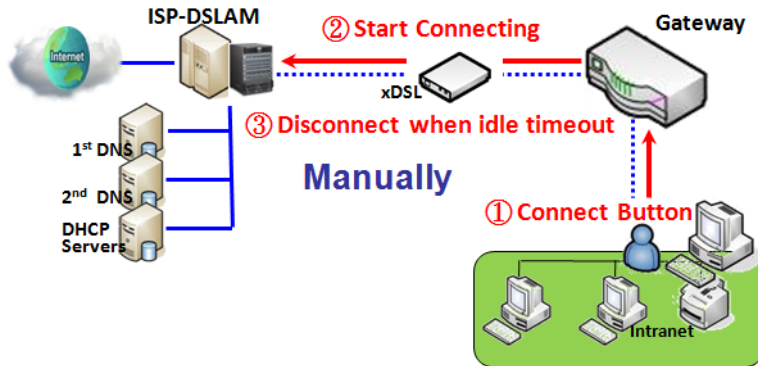

**Manually:** This gateway won't start to establish WAN connection until you press "Connect" button on web UI. After normal data transferring between LAN and WAN sides, this gateway will disconnect WAN connection if idle time reaches value of Maximum Idle Time.

Please be noted, if the WAN interface serves as the primary one for another WAN interface in Failover role, the Connection Control parameter will not be available to you to configure as the system must set it to "Auto-reconnect (Always on)".

## Network Monitoring

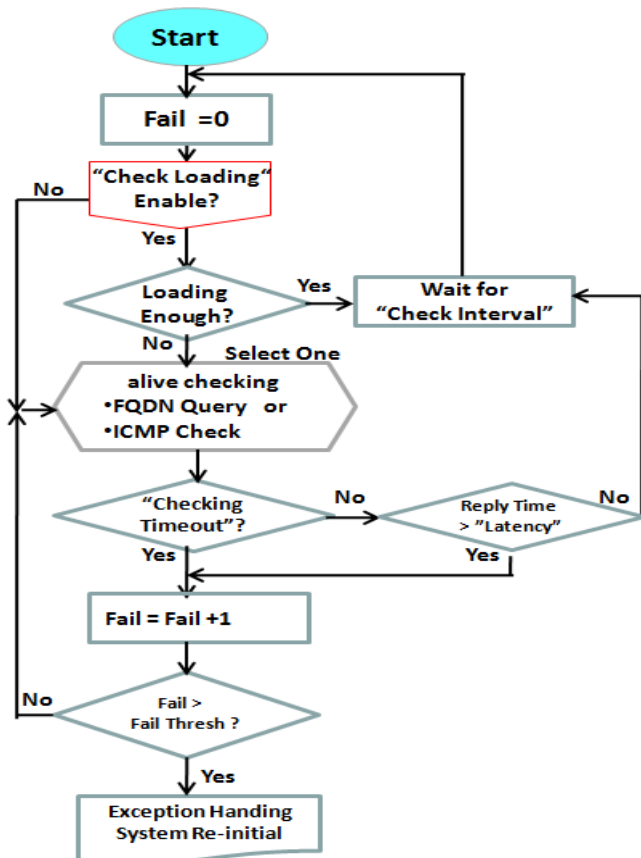

It is necessary to monitor connection status continuous. To do it, "ICMP Check" and "FQDN Query" are used to check. When there is traffic of connection, checking packet will waste bandwidth. Response time of replied packets may also increase. To avoid "Network Monitoring" work abnormally, enabling "Checking Loading" option will stop connection check when there is traffic. It will wait for another "Check Interval" and then check loading again.

When you do "Network Monitoring", if reply time longer than "Latency" or even no response longer than "Checking Timeout", "Fail" count will be increased. If it is continuous and "Fail" count is more than "Fail Threshold", gateway will do exception handling process and re-initial this connection again. Otherwise, network monitoring process will be start again.

# 4G IIoT Gateway

## Set up “Ethernet Common Configuration”

Ethernet WAN Common Configuration		
Item	Value setting	Description
<b>Connection Control</b>	A Must filled setting	<p>There are three connection modes.</p> <ul style="list-style-type: none"> <li>• <b>Auto-reconnect</b> enables the router to always keep the Internet connection on.</li> <li>• <b>Connect-on-demand</b> enables the router to automatically re-establish Internet connection as soon as user attempts to access the Internet. Internet connection will be disconnected when it has been inactive for a specified idle time.</li> <li>• <b>Connect Manually</b> allows user to connect to Internet manually. Internet connection will be inactive after it has been inactive for specified idle time.</li> </ul>
<b>Maximum Idle Time</b>	<ol style="list-style-type: none"> <li>1. An Optional setting</li> <li>2. By default <b>600</b> seconds is filled-in</li> </ol>	<p>Specify the maximum Idle time setting to disconnect the internet connection when the connection idle timed out.</p> <p><b>Value Range:</b> 300 ~ 86400.</p> <p><b>Note:</b> This field is available only when <b>Connect-on-demand</b> or <b>Connect Manually</b> is selected as the connection control scheme.</p>
<b>MTU Setup</b>	<ol style="list-style-type: none"> <li>1. An Optional setting</li> <li>2. <b>Uncheck</b> by default</li> </ol>	<p>Check the Enable box to enable the MTU (Maximum Transmission Unit) limit, and specify the <b>MTU</b> for the 3G/4G connection.</p> <p><b>MTU</b> refers to Maximum Transmission Unit. It specifies the largest packet size permitted for Internet transmission.</p> <p><b>Value Range:</b> 1200 ~ 1500.</p>
<b>MTU Setup</b>	<ol style="list-style-type: none"> <li>1. A Must filled setting</li> <li>2. <b>Auto</b> (value zero) is set by default</li> <li>3. Manual set range 1200~1500</li> </ol>	<p><b>MTU</b> refers to Maximum Transmission Unit. It specifies the largest packet size permitted for Internet transmission.</p> <p>When set to <b>Auto</b> (value '0'), the router selects the best MTU for best Internet connection performance.</p>
<b>NAT</b>	<ol style="list-style-type: none"> <li>1. An optional setting</li> <li>2. NAT is enabled by default</li> </ol>	<p>Enable NAT to apply NAT on the WAN connection. Uncheck the box to disable NAT function.</p>
<b>IGMP</b>	<ol style="list-style-type: none"> <li>1. A Must filled setting</li> <li>2. Disable is set by default</li> </ol>	<p>Enable IGMP (Internet Group Management Protocol) would enable the router to listen to IGMP packets to discover which interfaces are connected to which device. The router uses the interface information generated by IGMP to reduce bandwidth consumption in a multi-access network environment to avoid flooding the entire network.</p>
<b>WAN IP Alias</b>	<ol style="list-style-type: none"> <li>1. An optional setting</li> <li>2. <b>Uncheck</b> by default</li> </ol>	<p>Enable <b>WAN IP Alias</b> then enter the IP address provided by your service provider.</p> <p><b>WAN IP Alias</b> is used by the device router and is treated as a second set of WAN IP to provide dual WAN IP address to your LAN network.</p>

# 4G IIoT Gateway

Network Monitoring Configuration	
Item	Setting
▶ Network Monitoring Configuration	<input checked="" type="checkbox"/> Enable
▶ Checking Method	DNS Query ▼
▶ Loading Check	<input checked="" type="checkbox"/> Enable
▶ Query Interval	5 (seconds)
▶ Latency Threshold	3000 (ms)
▶ Fail Threshold	5 (Times)
▶ Target1	DNS1 ▼
▶ Target2	None ▼

Network Monitoring Configuration		
Item	Value setting	Description
<b>Network Monitoring Configuration</b>	1. An optional setting 2. Box is checked by default	Check the <b>Enable</b> box to activate the network monitoring function.
<b>Checking Method</b>	1. An Optional setting 2. <b>DNS Query</b> is set by default	Choose either <b>DNS Query</b> or <b>ICMP Checking</b> to detect WAN link. With <b>DNS Query</b> , the system checks the connection by sending DNS Query packets to the destination specified in Target 1 and Target 2. With <b>ICMP Checking</b> , the system will check connection by sending ICMP request packets to the destination specified in Target 1 and Target 2.
<b>Loading Check</b>	1. An optional setting 2. Box is checked by default	Check the <b>Enable</b> box to activate the loading check function. Enable Loading Check allows the gateway to ignore unreturned DNS queries or ICMP requests when WAN bandwidth is fully occupied. This is to prevent false link-down status.
<b>Query Interval</b>	1. An Optional setting 2. <b>5 seconds</b> is selected by default.	Specify a time interval as the <b>DNS Query Interval</b> . <b>Query Interval</b> defines the transmitting interval between two DNS Query or ICMP checking packets. With <b>DNS Query</b> , the system checks the connection by sending DNS Query packets to the destination specified in Target 1 and Target 2. <b>Value Range:</b> 2 ~ 14400.
<b>Check Interval</b>	1. An Optional setting 2. <b>5 seconds</b> is selected by default.	Specify a time interval as the <b>ICMP Checking Interval</b> . <b>Query Interval</b> defines the transmitting interval between two DNS Query or ICMP checking packets. With <b>ICMP Checking</b> , the system will check connection by sending ICMP request packets to the destination specified in Target 1 and Target 2. <b>Value Range:</b> 2 ~ 14400.
<b>Latency Threshold</b>	1. An Optional setting 2. <b>3000 ms</b> is set by default	Enter a number of detecting disconnection times to be the threshold before disconnection is acknowledged. <b>Latency Threshold</b> defines the tolerance threshold of responding time. <b>Value Range:</b> 2000 ~ 3000 seconds.
<b>Fail Threshold</b>	1. An Optional setting 2. <b>5 times</b> is set by default	Enter a number of detecting disconnection times to be the threshold before disconnection is acknowledged. <b>Fail Threshold</b> specifies the detected disconnection before the router recognize the WAN link down status.

# 4G IIoT Gateway

		<b><i>Value Range:</i></b> 1 ~ 10 times.
<b>Target 1</b>	1. An Optional filled setting 2. <b>DNS1</b> is selected by default	<b>Target1</b> specifies the first target of sending DNS query/ICMP request. <b>DNS1:</b> set the primary DNS to be the target. <b>DNS2:</b> set the secondary DNS to be the target. <b>Gateway:</b> set the Current gateway to be the target. <b>Other Host:</b> enter an IP address to be the target.
<b>Target 2</b>	1. An Optional filled setting 2. <b>None</b> is selected by default	<b>Target1</b> specifies the second target of sending DNS query/ICMP request. <b>None:</b> no second target is required. <b>DNS1:</b> set the primary DNS to be the target. <b>DNS2:</b> set the secondary DNS to be the target. <b>Gateway:</b> set the Current gateway to be the target. <b>Other Host:</b> enter an IP address to be the target.
<b>Save</b>	N/A	Click <b>Save</b> to save the settings.
<b>Undo</b>	N/A	Click <b>Undo</b> to cancel the settings.

# 4G IIoT Gateway

## Internet Connection – 3G/4G WAN

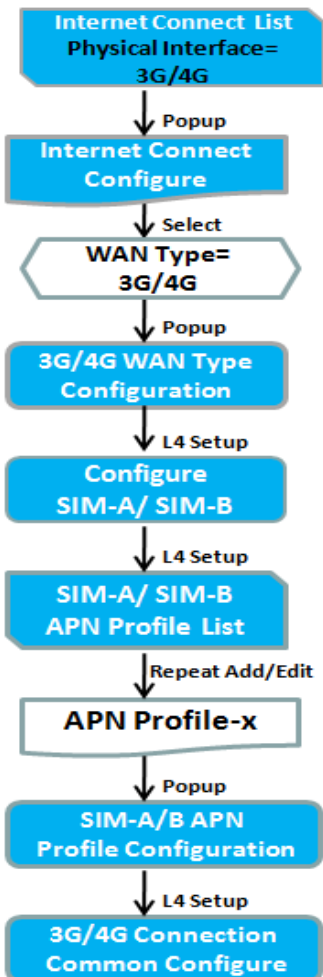

Internet Connection Configuration ( WAN - 2 )								
Item	Setting							
WAN Type	3G/4G ▾							
3G/4G WAN Type Configuration								
Item	Setting							
Preferred SIM Card	SIM-A First ▾    Failback : <input type="checkbox"/> Enable							
Connection with SIM-A Card								
Item	Setting							
Network Type	Auto ▾							
SIM-A APN Profile List    Add    Delete								
ID	Profile Name	APN	Account	Password	Authentication	Priority	Enable	Actions
SIM-A APN Profile Configuration								
Item	Setting							
Profile Name	Profile-1							
3G/4G Connection Common Configuration								
Item	Setting							
Connection Control	Auto-reconnect ▾							
Time Schedule	(0) Always ▾							
MTU	0    (0 is Auto)							
NAT	<input checked="" type="checkbox"/> Enable							

### Preferred SIM Card – Dual SIM Fail Over

For 3G/4G embedded device, one embedded cellular module can create only one WAN interface. This device has featured by using dual SIM cards for one module with special fail-over mechanism. It is called Dual SIM Failover. This feature is useful for ISP switch over when location is changed. Within “Dual SIM Failover”, there are various usage scenarios, including "SIM-A First", "SIM-B First“ with “Failback” enabled or not, and “SIM-A Only and “SIM-B Only”.

# 4G IIoT Gateway

**SIM-A/SIM-B only:** When “SIM-A Only” or “SIM-B Only” is used, the specified SIM slot card is the only one to be used for negotiation parameters between gateway device and cellular ISP.

## SIM-A / SIM-B first without enable Failback

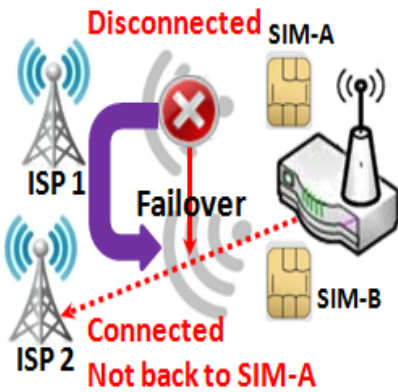

By default, “SIM-A First” scenario is used to connect to cellular ISP for data transfer. In the case of “SIM-A First” or “SIM-B First” scenario, the gateway will try to connect to the Internet by using SIM-A or SIM-B card first. And when the connection is broken, the gateway will switch to use the other SIM card for an alternate automatically and **will not switch back** to use original SIM card except current SIM connection is also broken. That is, SIM-A and SIM-B are used iteratively, but either one will keep being used for data transfer when current connection is still alive.

## SIM-A / SIM-B first with Failback enable

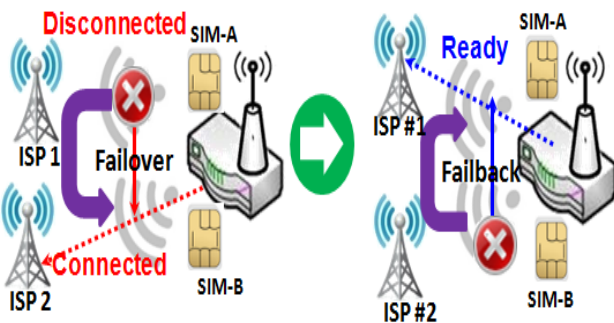

With Failback option enabled, “SIM-A First” scenario is used to connect when the connection is broken, gateway system will switch to use SIM-B. And when SIM-A connection is recovered, it will switch back to use original SIM-A card

# 4G IIoT Gateway

## Configure 3G/4G WAN Setting

When **Edit** button is applied, **Internet Connection Configuration**, and **3G/4G WAN Configuration** screens will appear.

Internet Connection Configuration ( WAN - 1 )	
Item	Setting
▶ WAN Type	3G/4G ▼

3G/4G WAN Type Configuration	
Item	Setting
▶ Preferred SIM Card	SIM-A First ▼ Failback : <input type="checkbox"/> Enable
▶ Auto Flight Mode	<input type="checkbox"/> Enable

3G/4G Connection Configuration		
Item	Value setting	Description
<b>WAN Type</b>	<ol style="list-style-type: none"> <li>1. A Must filled setting</li> <li>2. <b>3G/4G</b> is set by default.</li> </ol>	From the dropdown box, select Internet connection method for 3G/4G WAN Connection. Only <b>3G/4G</b> is available.
<b>Preferred SIM Card</b>	<ol style="list-style-type: none"> <li>1. A Must filled setting</li> <li>2. By default <b>SIM-A First</b> is selected</li> <li>3. <b>Failback</b> is unchecked by default</li> </ol>	<p>Choose which SIM card you want to use for the connection.</p> <p>When <b>SIM-A First</b> or <b>SIM-B First</b> is selected, it means the connection is built first by using SIM A/SIM B. And if the connection is failed, it will change to the other SIM card and try to dial again, until the connection is up.</p> <p>When <b>SIM-A only</b> or <b>SIM-B only</b> is selected, it will try to dial up only using the SIM card you selected.</p> <p>When <b>Failback</b> is checked, it means if the connection is dialed-up not using the main SIM you selected, it will fallback to the main SIM and try to establish the connection periodically.</p> <p><b>Note_1:</b> For the product with single SIM design, only <b>SIM-A Only</b> option is available.</p> <p><b>Note_2:</b> <b>Failback</b> is available only when <b>SIM-A First</b> or <b>SIM-B First</b> is selected.</p>
<b>Auto Flight Mode</b>	The box is unchecked by default	<p>Check the <b>Enable</b> box to activate the function.</p> <p>By default, if you disabled the <b>Auto Flight Mode</b>, the cellular module will always occupy a physical channel with cellular tower. It can get data connection instantly, and receive managing SMS all the time on required.</p> <p>If you enabled the <b>Auto Flight Mode</b>, the gateway will pop up a message <i>"Flight mode will cause cellular function to be malfunctioned when the data session is offline."</i>, and it will make the cellular module into flight mode and disconnected with cellular tower physically. In addition, whenever the cellular module is going to be used for data connection to back up the failed primary connection, the cellular module will be active to connect with cellular tower and get the data connection for use, It takes few more seconds.</p> <p><b>Note:</b> Keep it unchecked unless your cellular ISP asked the connected gateway to enable the Auto Flight Mode.</p>

# 4G IIoT Gateway

## Configure SIM-A / SIM-B Card

Here you can set configurations for the cellular connection according to your situation or requirement.

Connection with SIM-A Card	
Item	Setting
▶ Network Type	Auto ▼
▶ Dial-Up Profile	Manual-configuration ▼
▶ APN	<input type="text"/>
▶ IP Type	IPv4 ▼
▶ PIN Code	<input type="text"/> (Optional)
▶ Dial Number	<input type="text"/> (Optional)
▶ Account	<input type="text"/> (Optional)
▶ Password	<input type="text"/> (Optional)
▶ Authentication	Auto ▼
▶ IP Mode	Dynamic IP ▼
▶ Primary DNS	<input type="text"/> (Optional)
▶ Secondary DNS	<input type="text"/> (Optional)
▶ Roaming	<input type="checkbox"/> Enable

Note\_1: Configurations of SIM-B Card follows the same rule of Configurations of SIM-A Card, here we list SIM-A as the example.

Note\_2: Both **Connection with SIM-A Card** and **Connection with SIM-B Card** will pop up only when the **SIM-A First** or **SIM-B First** is selected, otherwise it only pops out one of them.

Connection with SIM-A/-B Card		
Item	Value setting	Description
<b>Network Type</b>	1. A Must filled setting 2. By default <b>Auto</b> is selected	Select <b>Auto</b> to register a network automatically, regardless of the network type.
		Select <b>LTE only</b> to register the LTE network only.
<b>Dial-Up Profile</b>	1. A Must filled setting 2. By default <b>Manual-configuration</b> is selected	<b>Note:</b> Options may be different due to the specification of the module.
		Specify the type of dial-up profile for your 3G/4G network. It can be <b>Manual-configuration</b> , <b>APN Profile List</b> , or <b>Auto-detection</b> . Select <b>Manual-configuration</b> to set <b>APN</b> (Access Point Name), <b>Dial Number</b> , <b>Account</b> , and <b>Password</b> to what your carrier provides. Select <b>APN Profile List</b> to set more than one profile to dial up in turn, until

# 4G IIoT Gateway

		<p>the connection is established. It will pop up a new filed, please go to <b>Basic Network &gt; WAN &amp; Uplink &gt; Internet Setup &gt; SIM-A APN Profile List</b> for details.</p> <p>Select <b>Auto-detection</b> to automatically bring out all configurations needed while dialing-up, by comparing the IMSI of the SIM card to the record listed in the manufacturer’s database.</p> <p><b>Note_1:</b> You are highly recommended to select the <b>Manual</b> or <b>APN Profile List</b> to specify the network for your subscription. Your ISP always provides such network settings for the subscribers.</p> <p><b>Note_2:</b> If you select <b>Auto-detection</b>, it is likely to connect to improper network, or failed to find a valid APN for your ISP.</p>
<b>APN</b>	<ol style="list-style-type: none"> <li>1. A Must filled setting</li> <li>2. String format : any text</li> </ol>	<p>Enter the <b>APN</b> you want to use to establish the connection. This is a must-filled setting if you selected <b>Manual-configuration</b> as dial-up profile scheme.</p>
<b>IP Type</b>	<ol style="list-style-type: none"> <li>1. A Must filled setting</li> <li>2. By default <b>IPv4</b> is selected</li> </ol>	<p>Specify the IP type of the network services provided by your 3G/4G network. It can be <b>IPv4</b>, <b>IPv6</b>, or <b>IPv4/6</b>.</p>
<b>PIN code</b>	<ol style="list-style-type: none"> <li>1. An Optional setting</li> <li>2. String format : interger</li> </ol>	<p>Enter the PIN (Personal Identification Number) code if it needs to unlock your SIM card.</p>
<b>Dial Number, Account, Password</b>	<ol style="list-style-type: none"> <li>1. An Optional setting</li> <li>2. String format : any text</li> </ol>	<p>Enter the optional <b>Dial Number</b>, <b>Account</b>, and <b>Password</b> settings if your ISP provided such settings to you.  <b>Note:</b> These settings are only displayed when Manual-configuration is selected.</p>
<b>Authentication</b>	<ol style="list-style-type: none"> <li>1. A Must filled setting</li> <li>2. By default <b>Auto</b> is selected</li> </ol>	<p>Select <b>PAP</b> (Password Authentication Protocol) and use such protocol to be authenticated with the carrier’s server.          Select <b>CHAP</b> (Challenge Handshake Authentication Protocol) and use such protocol to be authenticated with the carrier’s server.          When <b>Auto</b> is selected, it means it will authenticate with the server either <b>PAP</b> or <b>CHAP</b>.</p>
<b>IP Mode</b>	<ol style="list-style-type: none"> <li>1. A Must filled setting</li> <li>2. By default <b>Dynamic IP</b> is selected</li> </ol>	<p>When <b>Dynamic IP</b> is selected, it means it will get all IP configurations from the carrier’s server and set to the device directly.          If you have specific application provided by the carrier, and want to set IP configurations on your own, you can switch to <b>Static IP</b> mode and fill in all parameters that required, such as IP address, subnet mask and gateway.</p> <p><b>Note:</b> <b>IP Subnet Mask</b> is a must filled setting, and make sure you have the right configuration. Otherwise, the connection may get issues.</p>
<b>Primary DNS</b>	<ol style="list-style-type: none"> <li>1. An Optional setting</li> <li>2. String format : IP address (IPv4 type)</li> </ol>	<p>Enter the IP address to change the primary DNS (Domain Name Server) setting. If it is not filled-in, the server address is given by the carrier while dialing-up.</p>
<b>Secondary DNS</b>	<ol style="list-style-type: none"> <li>1. An Optional setting</li> <li>2. String format : IP address (IPv4 type)</li> </ol>	<p>Enter the IP address to change the secondary DNS (Domain Name Server) setting. If it is not filled-in, the server address is given by the carrier while dialing-up.</p>
<b>Roaming</b>	<p>The box is unchecked by default</p>	<p>Check the box to establish the connection even the registration status is roaming, not in home network.</p> <p><b>Note:</b> It may cost additional charges if the connection is under roaming.</p>

## Create/Edit SIM-A / SIM-B APN Profile List

# 4G IIoT Gateway

You can add a new APN profile for the connection, or modify the content of the APN profile you added. It is available only when you select **Dial-Up Profile** as **APN Profile List**.

SIM-A APN Profile List <span>Add</span> <span>Delete</span>									
ID	Profile Name	APN	IP Type	Account	Password	Authentication	Priority	Enable	Actions

List all the APN profile you created, easily for you to check and modify. It is available only when you select **Dial-Up Profile** as **APN Profile List**.

When **Add** button is applied, an **APN Profile Configuration** screen will appear.

SIM-A APN Profile Configuration	
Item	Setting
▶ Profile Name	<input type="text" value="Profile-1"/>
▶ APN	<input type="text"/>
▶ IP Type	IPv4 ▼
▶ Account	<input type="text"/> (Optional)
▶ Password	<input type="text"/> (Optional)
▶ Authentication	Auto ▼
▶ Priority	<input type="text"/>
▶ Profile	<input checked="" type="checkbox"/> Enable

SIM-A/-B APN Profile Configuration		
Item	Value setting	Description
<b>Profile Name</b>	1. By default <b>Profile-x</b> is listed 2. String format : any text	Enter the profile name you want to describe for this profile.
<b>APN</b>	String format : any text	Enter the <b>APN</b> you want to use to establish the connection.
<b>IP Type</b>	1. A Must filled setting 2. By default <b>IPv4</b> is selected	Specify the IP type of the network service provided by your 3G/4G network. It can be <b>IPv4</b> , <b>IPv6</b> , or <b>IPv4/6</b> .
<b>Account</b>	String format : any text	Enter the <b>Account</b> you want to use for the authentication. <b>Value Range: 0 ~ 53 characters.</b>
<b>Password</b>	String format : any text	Enter the <b>Password</b> you want to use for the authentication.
<b>Authentication</b>	1. A Must filled setting 2. By default <b>Auto</b> is selected	Select the Authentication method for the 3G/4G connection. It can be <b>Auto</b> , <b>PAP</b> , <b>CHAP</b> , or <b>None</b> .
<b>Priority</b>	1. A Must filled setting 2. String format : integer	Enter the value for the dialing-up order. The valid value is from 1 to 16. It will start to dial up with the profile that assigned with the smallest number. <b>Value Range: 1 ~ 16.</b>
<b>Profile</b>	The box is checked by default	Check the box to enable this profile. Uncheck the box to disable this profile in dialing-up action.
<b>Save</b>	N/A	Click the <b>Save</b> button to save the configuration.

# 4G IIoT Gateway

<b>Undo</b>	N/A	Click the <b>Undo</b> button to restore what you just configured back to the previous setting.
<b>Back</b>	N/A	When the <b>Back</b> button is clicked, the screen will return to the previous page.

## Setup 3G/4G Connection Common Configuration

Here you can change common configurations for 3G/4G WAN.

3G/4G Connection Common Configuration	
Item	Setting
▶ Connection Control	Auto-reconnect ▼
▶ Time Schedule	(0) Always ▼
▶ MTU Setup	<input type="checkbox"/> Enable
▶ IP Passthrough (Cellular Bridge)	<input type="checkbox"/> Enable Fixed MAC : <input type="text"/>
▶ NAT	<input checked="" type="checkbox"/> Enable
▶ IGMP	Disable ▼
▶ WAN IP Alias	<input type="checkbox"/> Enable <input type="text" value="10.0.0.1"/>

3G/4G Connection Common Configuration		
Item	Value setting	Description
<b>Connection Control</b>	By default <b>Auto-reconnect</b> is selected	<p>When <b>Auto-reconnect</b> is selected, it means it will try to keep the Internet connection on all the time whenever the physical link is connected.</p> <p>When <b>Connect-on-demand</b> is selected, it means the Internet connection will be established only when detecting data traffic.</p> <p>When <b>Connect Manually</b> is selected, it means you need to click the <b>Connect</b> button to dial up the connection manually. Please go to <b>Status &gt; Basic Network &gt; WAN &amp; Uplink</b> tab for details.</p> <p><b>Note:</b> If the WAN interface serves as the primary one for another WAN interface in Failover role( and vice versa), the Connection Control parameter will not be available on both WANs as the system must set it to "Auto-reconnect"</p>
<b>Maximum Idle Time</b>	<ol style="list-style-type: none"> <li>1. An Optional setting</li> <li>2. By default <b>600</b> seconds is filled-in</li> </ol>	<p>Specify the maximum Idle time setting to disconnect the internet connection when the connection idle timed out.</p> <p><b>Value Range:</b> 300 ~ 86400.</p> <p><b>Note:</b> This field is available only when <b>Connect-on-demand</b> or <b>Connect Manually</b> is selected as the connection control scheme.</p>
<b>Time Schedule</b>	<ol style="list-style-type: none"> <li>1. A Must filled setting</li> <li>2. By default <b>(0) Always</b> is selected</li> </ol>	<p>When <b>(0) Always</b> is selected, it means this WAN is under operation all the time. Once you have set other schedule rules, there will be other options to select. Please go to <b>Object Definition &gt; Scheduling</b> for details.</p>
<b>MTU Setup</b>	<ol style="list-style-type: none"> <li>1. An Optional setting</li> </ol>	Check the Enable box to enable the MTU (Maximum Transmission Unit)

# 4G IIoT Gateway

	2. <b>Uncheck</b> by default	limit, and specify the <b>MTU</b> for the 3G/4G connection. <b>MTU</b> refers to Maximum Transmission Unit. It specifies the largest packet size permitted for Internet transmission. <b>Value Range: 1200 ~ 1500.</b>
<b>IP Pass-through (Cellular Bridge)</b>	1. The box is unchecked by default 2. String format for <b>Fixed MAC</b> : MAC address, e.g. 00:50:18:aa:bb:cc	When <b>Enable</b> box is checked, it means the device will directly assign the WAN IP to the first connected local LAN client. However, when an optional <b>Fixed MAC</b> is filled-in a non-zero value, it means only the client with this MAC address can get the WAN IP address.  <b>Note:</b> When the <b>IP Pass-through</b> is on, <b>NAT</b> and <b>WAN IP Alias</b> will be unavailable until the function is disabled again.
<b>NAT</b>	<b>Check</b> by default	Uncheck the box to disable <b>NAT</b> (Network Address Translation) function.
<b>IGMP</b>	By default <b>Disable</b> is selected	Select <b>Auto</b> to enable <b>IGMP</b> function. Check the <b>Enable</b> box to enable <b>IGMP Proxy</b> .
<b>WAN IP Alias</b>	1. Unchecked by default 2. String format: IP address (IPv4 type)	Check the box to enable <b>WAN IP Alias</b> , and fill in the IP address you want to assign.

Network Monitoring Configuration	
Item	Setting
▶ Network Monitoring Configuration	<input checked="" type="checkbox"/> Enable
▶ Checking Method	DNS Query ▼
▶ Loading Check	<input checked="" type="checkbox"/> Enable
▶ Query Interval	5 (seconds)
▶ Latency Threshold	3000 (ms)
▶ Fail Threshold	5 (Times)
▶ Target1	DNS1 ▼
▶ Target2	None ▼

Network Monitoring Configuration		
Item	Value setting	Description
<b>Network Monitoring Configuration</b>	1. An optional setting 2. Box is checked by default	Check the <b>Enable</b> box to activate the network monitoring function.
<b>Checking Method</b>	1. An Optional setting 2. <b>DNS Query</b> is set by default	Choose either <b>DNS Query</b> or <b>ICMP Checking</b> to detect WAN link. With <b>DNS Query</b> , the system checks the connection by sending DNS Query packets to the destination specified in Target 1 and Target 2. With <b>ICMP Checking</b> , the system will check connection by sending ICMP request packets to the destination specified in Target 1 and Target 2.
<b>Loading Check</b>	1. An optional setting 2. Box is checked by default	Check the <b>Enable</b> box to activate the loading check function. Enable Loading Check allows the gateway to ignore unreturned DNS queries or ICMP requests when WAN bandwidth is fully occupied. This is to prevent false link-down status.

# 4G IIoT Gateway

<b>Query Interval</b>	<ol style="list-style-type: none"> <li>1. An Optional setting</li> <li>2. <b>5 seconds</b> is selected by default.</li> </ol>	<p>Specify a time interval as the <b>DNS Query Interval</b>.  <b>Query Interval</b> defines the transmitting interval between two DNS Query or ICMP checking packets.            With <b>DNS Query</b>, the system checks the connection by sending DNS Query packets to the destination specified in Target 1 and Target 2.  <b>Value Range:</b> 2 ~ 14400.</p>
<b>Check Interval</b>	<ol style="list-style-type: none"> <li>1. An Optional setting</li> <li>2. <b>5 seconds</b> is selected by default.</li> </ol>	<p>Specify a time interval as the <b>ICMP Checking Interval</b>.  <b>Query Interval</b> defines the transmitting interval between two DNS Query or ICMP checking packets.            With <b>ICMP Checking</b>, the system will check connection by sending ICMP request packets to the destination specified in Target 1 and Target 2.  <b>Value Range:</b> 2 ~ 14400.</p>
<b>Latency Threshold</b>	<ol style="list-style-type: none"> <li>1. An Optional setting</li> <li>2. <b>3000 ms</b> is set by default</li> </ol>	<p>Enter a number of detecting disconnection times to be the threshold before disconnection is acknowledged.  <b>Latency Threshold</b> defines the tolerance threshold of responding time.  <b>Value Range:</b> 2000 ~ 3000 seconds.</p>
<b>Fail Threshold</b>	<ol style="list-style-type: none"> <li>1. An Optional setting</li> <li>2. <b>5 times</b> is set by default</li> </ol>	<p>Enter a number of detecting disconnection times to be the threshold before disconnection is acknowledged.  <b>Fail Threshold</b> specifies the detected disconnection before the router recognize the WAN link down status.  <b>Value Range:</b> 1 ~ 10 times.</p>
<b>Target 1</b>	<ol style="list-style-type: none"> <li>1. An Optional filled setting</li> <li>2. <b>DNS1</b> is selected by default</li> </ol>	<p><b>Target1</b> specifies the first target of sending DNS query/ICMP request.  <b>DNS1:</b> set the primary DNS to be the target.  <b>DNS2:</b> set the secondary DNS to be the target.  <b>Gateway:</b> set the Current gateway to be the target.  <b>Other Host:</b> enter an IP address to be the target.</p>
<b>Target 2</b>	<ol style="list-style-type: none"> <li>1. An Optional filled setting</li> <li>2. <b>None</b> is selected by default</li> </ol>	<p><b>Target1</b> specifies the second target of sending DNS query/ICMP request.  <b>None:</b> no second target is required.  <b>DNS1:</b> set the primary DNS to be the target.  <b>DNS2:</b> set the secondary DNS to be the target.  <b>Gateway:</b> set the Current gateway to be the target.  <b>Other Host:</b> enter an IP address to be the target.</p>
<b>Save</b>	N/A	Click <b>Save</b> to save the settings.
<b>Undo</b>	N/A	Click <b>Undo</b> to cancel the settings.

# 4G IIoT Gateway

## 2.2 LAN & VLAN

This section provides the configuration of LAN and VLAN. VLAN is an optional feature, and it depends on the product specification of the purchased gateway.

### 2.2.1 Ethernet LAN

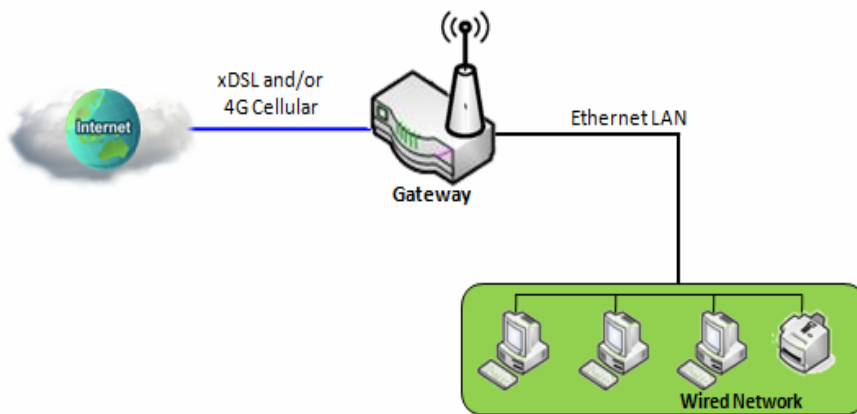

The Local Area Network (LAN) can be used to share data or files among computers attached to a network. Following diagram illustrates the network that wired and interconnects computers.

Please follow the following instructions to do IPv4 Ethernet LAN Setup.

Configuration	
Item	Setting
▶ IP Mode	Static IP
▶ LAN IP Address	<input type="text" value="192.168.0.1"/>
▶ Subnet Mask	<input type="text" value="255.255.255.0 (/24)"/>

Configuration		
Item	Value setting	Description
<b>IP Mode</b>	N/A	It shows the LAN IP mode for the gateway according the related configuration. <b>Static IP:</b> If there is at least one WAN interface activated, the LAN IP mode is fixed in Static IP mode. <b>Dynamic IP:</b> If all the available WAN interfaces are disabled, the LAN IP mode can be Dynamic IP mode.
<b>LAN IP Address</b>	1. A Must filled setting 2. 192.168.0.1 is set by default	Enter the local IP address of this device. The network device(s) on your network must use the LAN IP address of this device as their Default Gateway. You can change it if necessary.  <b>Note:</b> It's also the IP address of web UI. If you change it, you need to type new IP address in the browser to see web UI.
<b>Subnet Mask</b>	1. A Must filled setting 2. 255.255.255.0 (/24) is set	Select the subnet mask for this gateway from the dropdown list. Subnet mask defines how many clients are allowed in one network or subnet.

# 4G IIoT Gateway

	by default	The default subnet mask is 255.255.255.0 (/24), and it means maximum 254 IP addresses are allowed in this subnet. However, one of them is occupied by LAN IP address of this gateway, so there are maximum 253 clients allowed in LAN network. <b>Value Range:</b> 255.0.0.0 (/8) ~ 255.255.255.252 (/30).
<b>Save</b>	N/A	Click the <b>Save</b> button to save the configuration
<b>Undo</b>	N/A	Click the <b>Undo</b> button to restore what you just configured back to the previous setting.

## Create / Edit Additional IP

This gateway provides the LAN IP alias function for some special management consideration. You can add additional LAN IP for this gateway, and access to this gateway with the additional IP.

Additional IP <input type="button" value="Add"/> <input type="button" value="Delete"/>						
ID	Name	Interface	IP Address	Subnet Mask	Enable	Action

When **Add** button is applied, **Additional IP Configuration** screen will appear.

Additional IP Configuration	
Item	Setting
▶ Name	<input type="text"/>
▶ Interface	lo ▼
▶ IP Address	<input type="text"/>
▶ Subnet Mask	255.255.255.0 (/24) ▼
▶ Enable	<input type="checkbox"/>
<input type="button" value="Save"/>	

Configuration		
Item	Value setting	Description
<b>Name</b>	.1 An Optional Setting	Enter the name for the alias IP address.
<b>Interface</b>	1. A Must filled setting 2. lo is set by default	Specify the Interface type. It can be lo or br0.
<b>IP Address</b>	1. An Optional setting 2. 192.168.0.1 is set by default	Enter the addition IP address for this device.
<b>Subnet Mask</b>	1. A Must filled setting 2. 255.255.255.0 (/24) is set by default	Select the subnet mask for this gateway from the dropdown list. Subnet mask defines how many clients are allowed in one network or subnet. The default subnet mask is 255.255.255.0 (/24), and it means maximum 254 IP addresses are allowed in this subnet. However, one of them is occupied by LAN IP address of this gateway, so there are maximum 253 clients allowed in LAN

# 4G IloT Gateway

---

		network. <b><i>Value Range:</i></b> 255.0.0.0 (/8) ~ 255.255.255.255 (/32).
<b>Save</b>	NA	Click the <b>Save</b> button to save the configuration

# 4G IIoT Gateway

## 2.2.2 VLAN

VLAN (Virtual LAN) is a logical network under a certain switch or router device to group client hosts with a specific VLAN ID. This gateway supports both Port-based VLAN and Tag-based VLAN. These functions allow you to divide local network into different “virtual LANs”. It is common requirement for some application scenario. For example, there are various departments within SMB. All client hosts in the same department should own common access privilege and QoS property. You can assign departments either by port-based VLAN or tag-based VLAN as a group, and then configure it by your plan. In some cases, ISP may need router to support “VLAN tag” for certain kinds of services (e.g. IPTV). You can group all devices required this service as one tag-based VLAN.

If the gateway has only one physical Ethernet LAN port, only very limited configuration is available if you enable the Port-based VLAN.

### ➤ Port-based VLAN

Port-based VLAN function can group Ethernet ports, Port-1 ~ Port-4, and WiFi Virtual Access Points, VAP-1 ~ VAP-8, together for differentiated services like Internet surfing, multimedia enjoyment, VoIP talking, and so on. Two operation modes, NAT and Bridge, can be applied to each VLAN group. One DHCP server can be allocated for a NAT VLAN group to let group host member get its IP address. Thus, each host can surf Internet via the NAT mechanism of business access gateway. In bridge mode, Intranet packet flow is delivered out WAN trunk port with VLAN tag to upper link for different services.

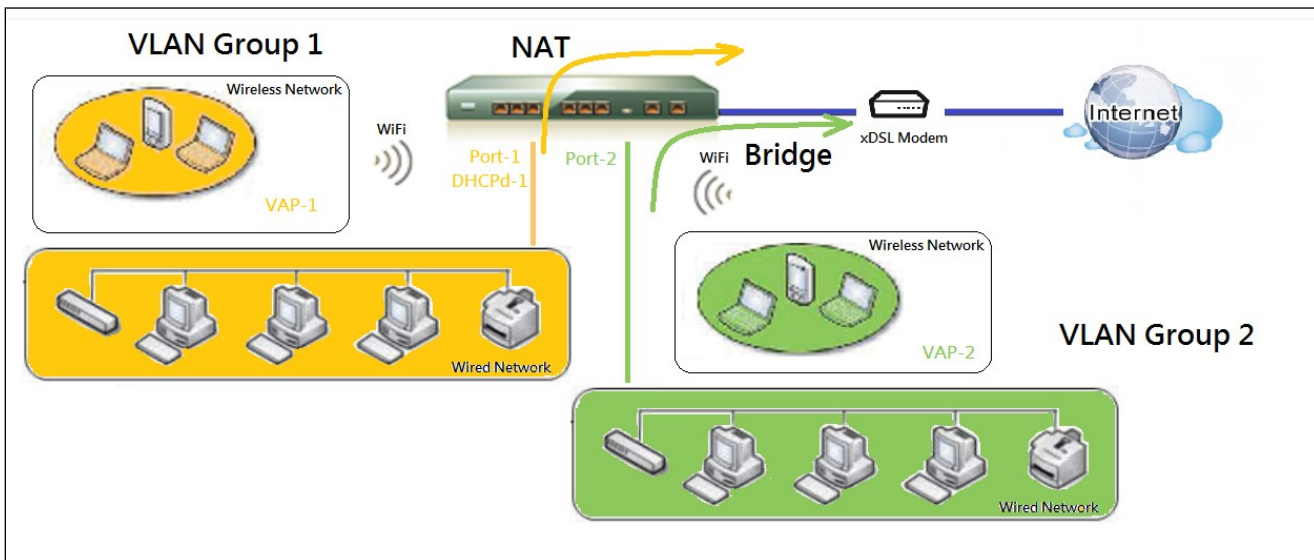

A port-based VLAN is a group of ports on an Ethernet or Virtual APs of Wired or Wireless Gateway that form a logical LAN segment. Following is an example.

For example, in a company, administrator schemes out 3 network segments, Lobby/Meeting Room, Office, and Data Center. In a Wireless Gateway, administrator can configure Lobby/Meeting Room segment with VLAN ID 3. The VLAN group includes Port-3 and VAP-8 (SSID: Guest) with NAT mode and DHCP-3 server equipped. He also configure Office segment with VLAN ID 2. The VLAN group includes Port-2 and VAP-1 (SSID:

# 4G IIoT Gateway

Staff) with NAT mode and DHCP-2 server equipped. At last, administrator also configure Data Center segment with VLAN ID 1. The VLAN group includes Port-1 with NAT mode to WAN interface as shown in following diagram.

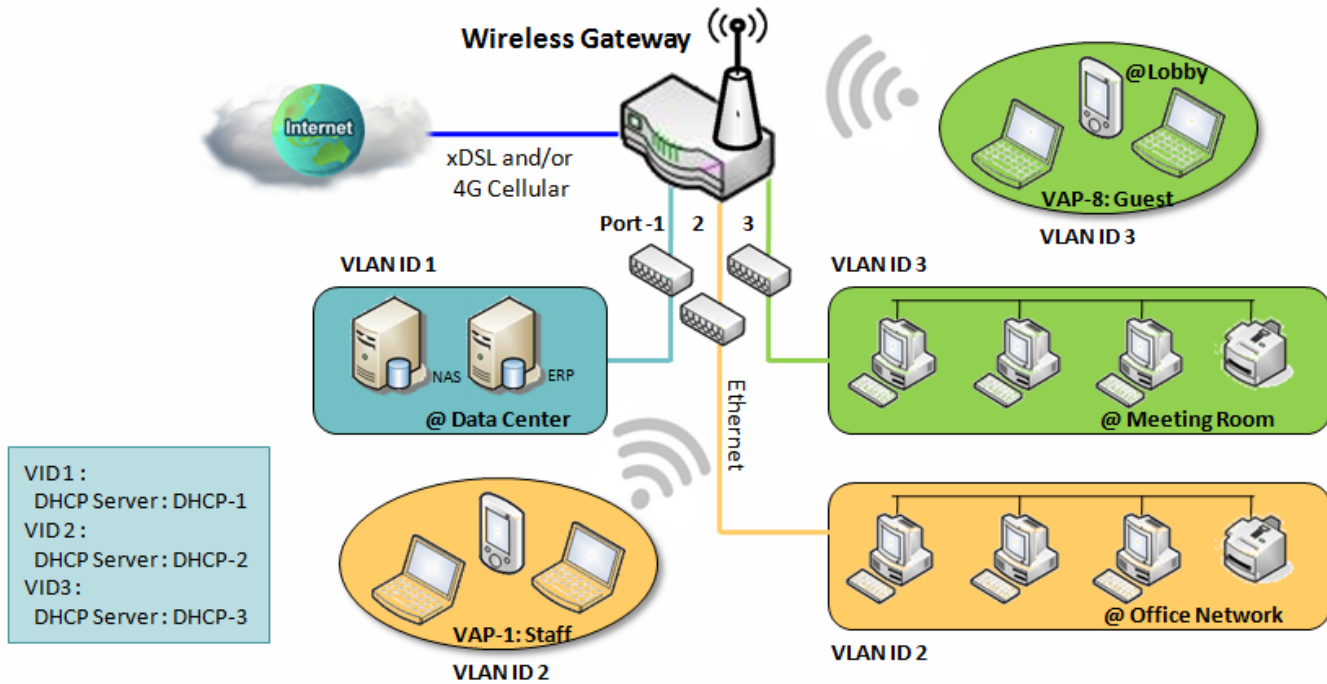

Above is the general case for 3 Ethernet LAN ports in the gateway. But if the device just has one Ethernet LAN port, there will be only one VLAN group for the device. Under such situation, it still supports both the NAT and Bridge mode for the Port-based VLAN configuration.

## ➤ Tag-based VLAN

Tag-based VLAN function can group Ethernet ports, Port-1 ~ Port-4, and WiFi Virtual Access Points, VAP-1 ~ VAP-8, together with different VLAN tags for deploying subnets in Intranet. All packet flows can carry with different VLAN tags even at the same physical Ethernet port for Intranet. These flows can be directed to different destination because they have differentiated tags. The approach is very useful to group some hosts at different geographic location to be in the same workgroup.

Tag-based VLAN is also called a VLAN Trunk. The VLAN Trunk collects all packet flows with different VLAN IDs from Router device and delivers them in the Intranet. VLAN membership in a tagged VLAN is determined by VLAN ID information within the packet frames that are received on a port. Administrator can further use a VLAN switch to separate the VLAN trunk to different groups based on VLAN ID. Following is an example.

# 4G IIoT Gateway

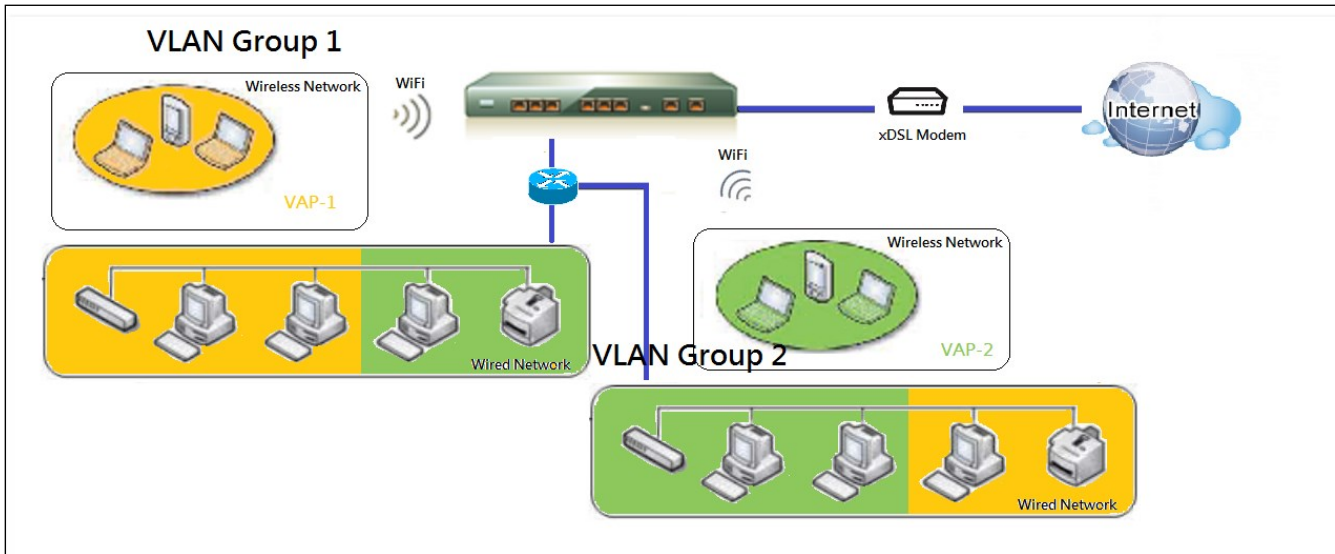

For example, in a company, administrator schemes out 3 network segments, Lab, Meeting Rooms, and Office. In a Security VPN Gateway, administrator can configure Office segment with VLAN ID 12. The VLAN group is equipped with DHCP-3 server to construct a 192.168.12.x subnet. He also configure Meeting Rooms segment with VLAN ID 11. The VLAN group is equipped with DHCP-2 server to construct a 192.168.11.x subnet for Intranet only. That is, any client host in VLAN 11 group can't access the Internet. At last, he configures Lab segment with VLAN ID 10. The VLAN group is equipped with DHCP-1 server to construct a 192.168.10.x subnet.

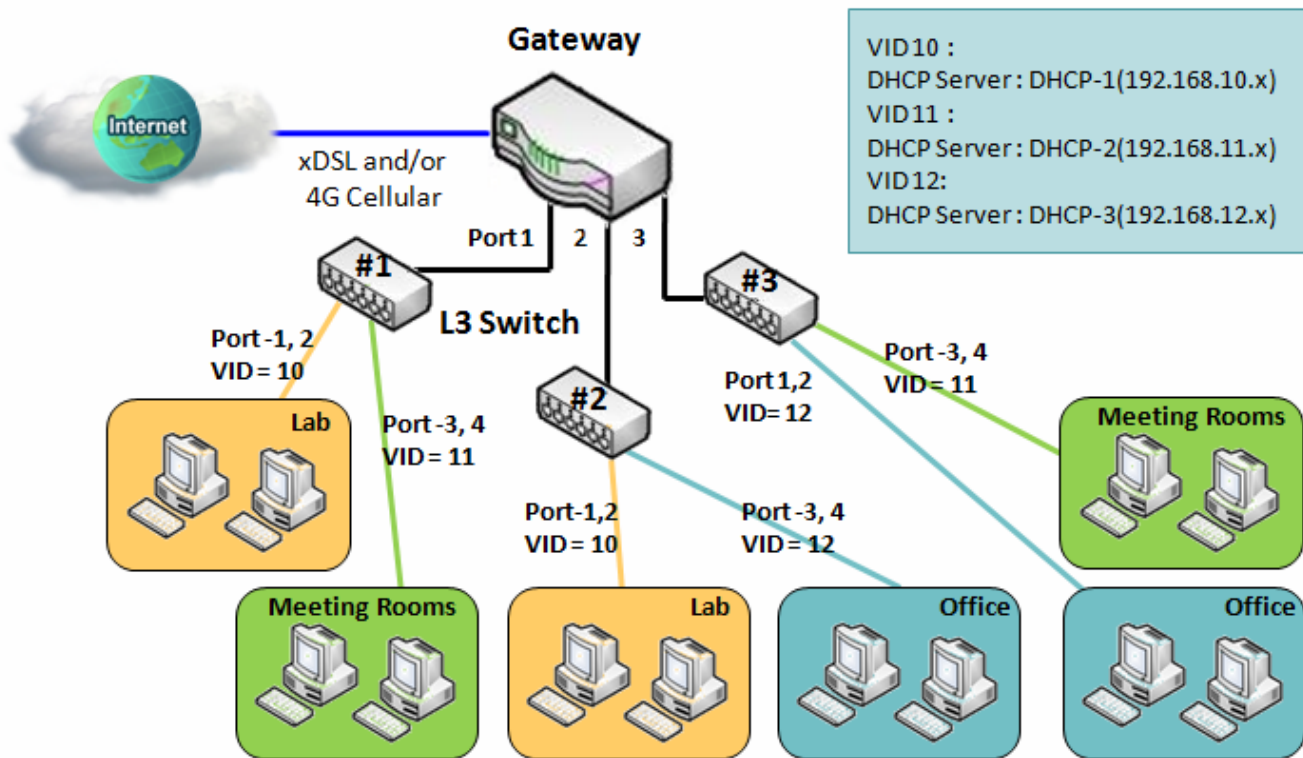

# 4G IIoT Gateway

## ➤ VLAN Groups Access Control

Administrator can specify the Internet access permission for all VLAN groups. He can also configure which VLAN groups are allowed to communicate with each other.

### VLAN Group Internet Access

Administrator can specify members of one VLAN group to be able to access Internet or not. Following is an example that VLAN groups of VID is 2 and 3 can access Internet but the one with VID is 1 cannot access Internet. That is, visitors in meeting room and staffs in office network can access Internet. But the computers/servers in data center cannot access Internet since security consideration. Servers in data center only for trusted staffs or are accessed in secure tunnels.

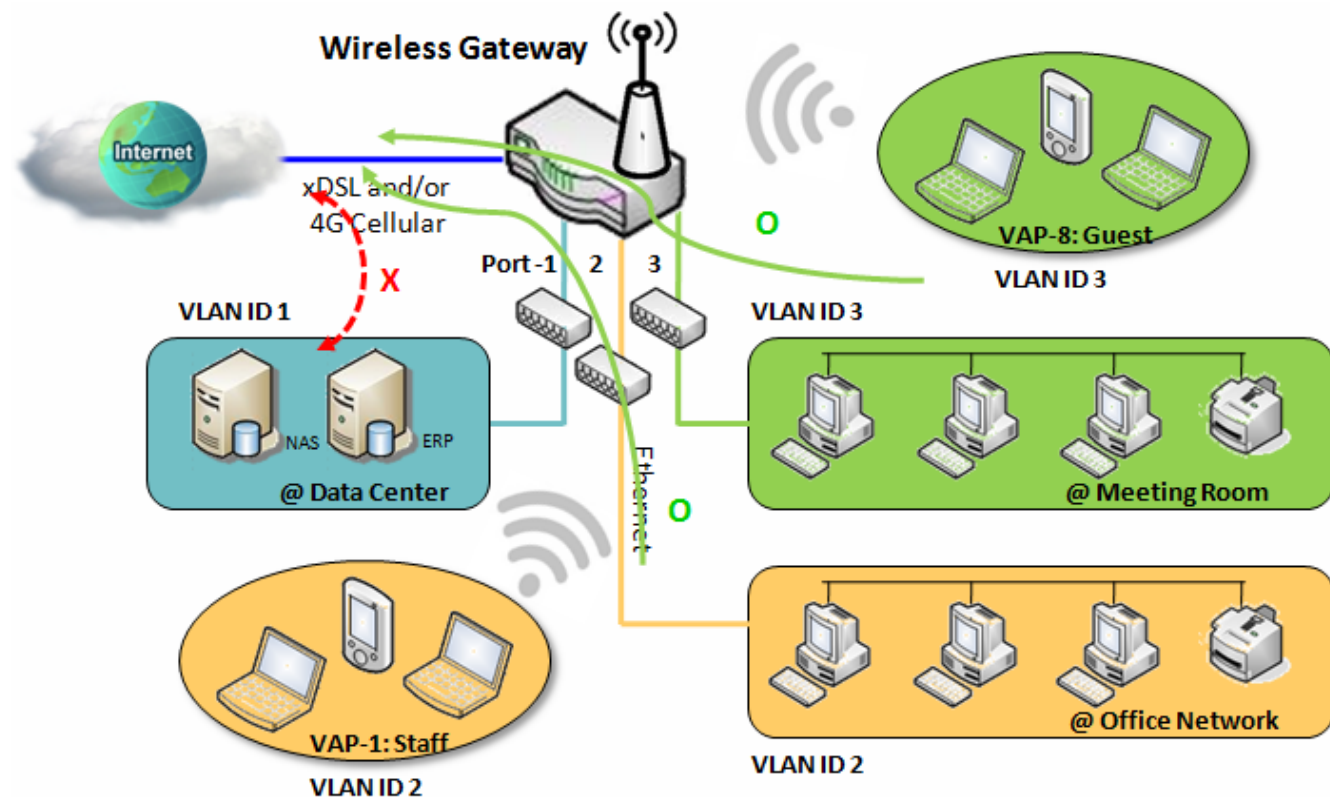

# 4G IIoT Gateway

## Inter VLAN Group Routing:

In Port-based tagging, administrator can specify member hosts of one VLAN group to be able to communicate with the ones of another VLAN group or not. This is a communication pair, and one VLAN group can join many communication pairs. But communication pair doesn't have the transitive property. That is, A can communicate with B, and B can communicate with C, it doesn't imply that A can communicate with C. An example is shown at following diagram. VLAN groups of VID is 1 and 2 can access each other but the ones between VID 1 and VID 3 and between VID 2 and VID 3 can't.

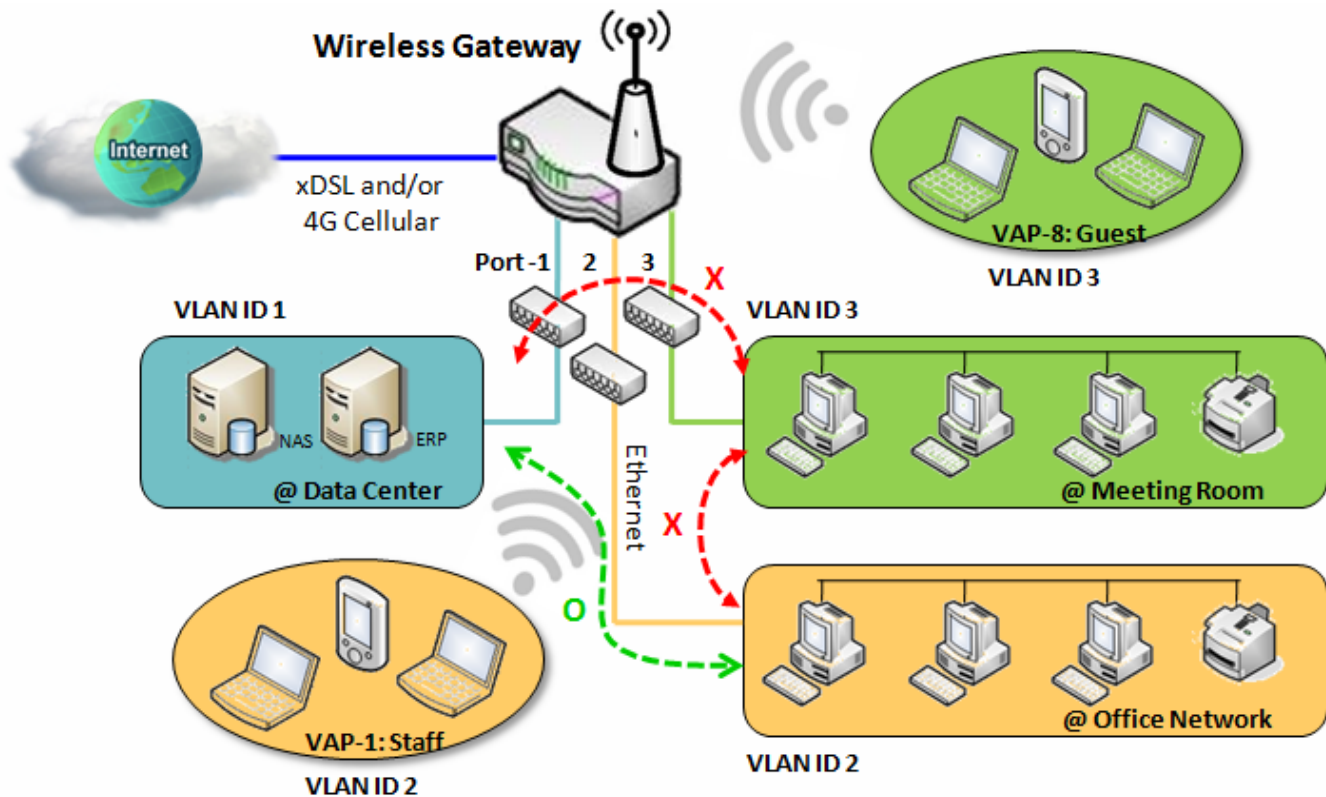

# 4G IIoT Gateway

## VLAN Setting

Go to **Basic Network > LAN & VLAN > VLAN** Tab.

The VLAN function allows you to divide local network into different virtual LANs. There are Port-based and Tag-based VLAN types. Select one that applies.

Configuration [ Help ]	
Item	Setting
▶ VLAN Types	Port-based ▼
▶ System Reserved VLAN ID	Start ID <input type="text" value="1"/> (1-4091) ~ End ID <input type="text" value="5"/>

Configuration		
Item	Value setting	Description
<b>VLAN Type</b>	<b>Port-based</b> is selected by default	Select the VLAN type that you want to adopt for organizing you local subnets. <b>Port-based:</b> Port-based VLAN allows you to add rule for each LAN port, and you can do advanced control with its VLAN ID. <b>Tag-based:</b> Tag-based VLAN allows you to add VLAN ID, and select member and DHCP Server for this VLAN ID. Go to <b>Tag-based VLAN List</b> table.
<b>System Reserved VLAN ID</b>	1 ~ 5 is reserved by default	Specify the VLAN ID range that is reserved for the system operation. For the Port-based/Tag-based VLAN grouping, only use the ID outside the reserved range. <b>Value Range:</b> 1 ~ 4091.
<b>Save</b>	NA	Click the <b>Save</b> button to save the configuration

## Port-based VLAN – Create/Edit VLAN Rules

The port-based VLAN allows you to custom each LAN port. There is a default rule shows the configuration of all LAN ports. Also, if your device has a DMZ port, you will see DMZ configuration, too. The maxima rule numbers is based on LAN port numbers.

Port-based VLAN List <input type="button" value="Add"/> <input type="button" value="Delete"/>										
Name	VLAN ID	VLAN Tagging	NAT / Bridge	Port Members	LAN IP Address	Subnet Mask	Joined WAN	WAN VID	Enable	Actions
DMZ	4094	X	NAT	DMZ Port	192.168.6.254	255.255.255.0	WAN - 1	0	<input checked="" type="checkbox"/>	<input type="button" value="Edit"/>
LAN	Native VLAN	X	NAT	<input type="button" value="Detail"/>	192.168.123.254	255.255.255.0	All WANs	0	<input checked="" type="checkbox"/>	<input type="button" value="Edit"/>

When **Add** button is applied, Port-based VLAN Configuration screen will appear, which is including 3 sections: **Port-based VLAN Configuration**, **IP Fixed Mapping Rule List**, and **Inter VLAN Group Routing** (enter through a

# 4G IIoT Gateway

button)

## Port-based VLAN - Configuration

Port-based VLAN Configuration	
Item	Setting
▶ Name	VLAN - 1
▶ VLAN ID	
▶ VLAN Tagging	Disable ▼
▶ NAT / Bridge	NAT ▼
▶ Port Members	Port: <input type="checkbox"/> PORT-1 <input type="checkbox"/> PORT-2 <input type="checkbox"/> PORT-3 <input type="checkbox"/> PORT-4 2.4G: <input type="checkbox"/> VAP-1 <input type="checkbox"/> VAP-2 <input type="checkbox"/> VAP-3 <input type="checkbox"/> VAP-4 <input type="checkbox"/> VAP-5 <input type="checkbox"/> VAP-6 <input type="checkbox"/> VAP-7 <input type="checkbox"/> VAP-8
▶ LAN to Join	<input type="checkbox"/> Enable <input type="text" value="DHCP 1"/> ▼

Port-based VLAN Configuration (part-I)		
Item	Value setting	Description
<b>Name</b>	1. A Must filled setting 2. String format: already have default texts	Define the <b>Name</b> of this rule. It has a default text and cannot be modified.
<b>VLAN ID</b>	A Must filled setting	Define the VLAN ID number, range is 1~4094.
<b>VLAN Tagging</b>	<b>Disable</b> is selected by default.	The rule is activated according to <b>VLAN ID</b> and <b>Port Members</b> configuration when <b>Enable</b> is selected.  The rule is activated according <b>Port Members</b> configuration when <b>Disable</b> is selected.
<b>NAT / Bridge</b>	<b>NAT</b> is selected by default.	Select <b>NAT</b> mode or <b>Bridge</b> mode for the rule.
<b>Port Members</b>	These boxes are unchecked by default.	Select which LAN port(s) and VAP(s) that you want to add to the rule. Note: The available member list can be different for the purchased product.
<b>LAN to Join</b>	The box is unchecked by default.	Check the Enable box and select one of the defined DHCP Server for the List to define the DHCP server for the VLAN group. If you enabled this function, all the rest settings will be greyed out, not required to configured manually.
<b>Save</b>	NA	Click the <b>Save</b> button to save the configuration
<b>Undo</b>	NA	Click the <b>Undo</b> button to restore what you just configured back to the previous setting.

If you didn't decide to bind the VLAN group to a pre-defined DHCP server, you have to further specify the following settings.

# 4G IIoT Gateway

▶ WAN & WAN VID to Join	All WANs ▾ <input type="button" value="None"/>
▶ LAN IP Address	<input type="text" value="192.168.2.254"/>
▶ Subnet Mask	<input type="text" value="255.255.255.0 (/24)"/> ▾
▶ DHCP Server / Relay	Server ▾
▶ DHCP Server Name	<input type="text"/>
▶ IP Pool	Starting Address: <input type="text" value="192.168.2.100"/> Ending Address: <input type="text" value="192.168.2.200"/>
▶ Lease Time	<input type="text" value="86400"/> seconds
▶ Domain Name	<input type="text"/> (Optional)
▶ Primary DNS	<input type="text"/> (Optional)
▶ Secondary DNS	<input type="text"/> (Optional)
▶ Primary WINS	<input type="text"/> (Optional)
▶ Secondary WINS	<input type="text"/> (Optional)
▶ Gateway	<input type="text"/> (Optional)
▶ Enable	<input type="checkbox"/>

Port-based VLAN Configuration (part-II)		
Item	Value setting	Description
<b>WAN &amp; WAN VID to Join</b>	All WANs is selected by default.	Select which <b>WAN</b> or <b>All WANs</b> that allow accessing Internet. Note: If Bridge mode is selected, you need to select a WAN and enter a VID.
<b>LAN IP Address</b>	A Must filled setting	Assign an <b>IP Address</b> for the DHCP Server that the rule used, this IP address is a gateway IP.
<b>Subnet Mask</b>	<b>255.255.255.0(/24)</b> is selected by default.	Select a <b>Subnet Mask</b> for the DHCP Server.
<b>DHCP Server /Relay</b>	<b>Server</b> is selected by default.	Define the <b>DHCP Server</b> type. There are three types you can select: <b>Server</b> , <b>Relay</b> , and <b>Disable</b> . <b>Relay</b> : Select <b>Relay</b> to enable DHCP Relay function for the VLAN group, and you only need to fill the <b>DHCP Server IP Address</b> field. <b>Server</b> : Select <b>Server</b> to enable DHCP Server function for the VLAN group, and you need to specify the DHCP Server settings. <b>Disable</b> : Select <b>Disable</b> to disable the DHCP Server function for the VLAN group.
<b>DHCP Server IP Address (for DHCP Relay only)</b>	A Must filled setting	If you select <b>Relay</b> type of DHCP Server, assign a <b>DHCP Server IP Address</b> that the gateway will relay the DHCP requests to the assigned DHCP server.
<b>DHCP Option 82 (for DHCP Relay only)</b>	An Optional filled setting	If you select <b>Relay</b> type of DHCP Server, you can further enable the DHCP Option 82 setting if the DHCP server support it.
<b>DHCP Server Name</b>	A Must filled setting	Define name of the DHCP Server for the specified VLAN group.
<b>IP Pool</b>	A Must filled setting	Define the IP Pool range.

## 4G IIoT Gateway

---

		There are <b>Starting Address</b> and <b>Ending Address</b> fields. If a client requests an IP address from this DHCP Server, it will assign an IP address in the range of <b>IP pool</b> .
<b>Lease Time</b>	A Must filled setting	Define a period of time for an IP Address that the DHCP Server leases to a new device. By default, the <b>lease time</b> is 86400 seconds.
<b>Domain Name</b>	String format can be any text	The Domain Name of this DHCP Server. <b>Value Range:</b> 0 ~ 31 characters.
<b>Primary DNS</b>	IPv4 format	The Primary DNS of this DHCP Server.
<b>Secondary DNS</b>	IPv4 format	The Secondary DNS of this DHCP Server.
<b>Primary WINS</b>	IPv4 format	The Primary WINS of this DHCP Server.
<b>Secondary WINS</b>	IPv4 format	The Secondary WINS of this DHCP Server.
<b>Gateway</b>	IPv4 format	The Gateway of this DHCP Server.
<b>Enable</b>	The box is unchecked by default.	Click <b>Enable</b> box to activate this rule.
<b>Save</b>	NA	Click the <b>Save</b> button to save the configuration
<b>Undo</b>	NA	Click the <b>Undo</b> button to restore what you just configured back to the previous setting.

# 4G IIoT Gateway

Besides, you can add some IP rules in the **IP Fixed Mapping Rule List** if DHCP Server for the VLAN groups is required.

IP Fixed Mapping Rule List
Add
Delete

MAC Address	IP Address	Enable	Actions
-------------	------------	--------	---------

Mapping Rule Configuration

Item	Setting
▶ MAC Address	<input style="width: 90%;" type="text"/>
▶ IP Address	<input style="width: 90%;" type="text"/>
▶ Enable	<input type="checkbox"/>

Save

When **Add** button is applied, **Mapping Rule Configuration** screen will appear.

Mapping Rule Configuration		
Item	Value setting	Description
<b>MAC Address</b>	A Must filled setting	Define the <b>MAC Address</b> target that the DHCP Server wants to match.
<b>IP Address</b>	A Must filled setting	Define the <b>IP Address</b> that the DHCP Server will assign. If there is a request from the MAC Address filled in the above field, the DHCP Server will assign this <b>IP Address</b> to the client whose <b>MAC Address</b> matched the rule.
<b>Enable</b>	The box is unchecked by default.	Click <b>Enable</b> box to activate this rule.
<b>Save</b>	NA	Click the <b>Save</b> button to save the configuration

Note: ensure to always click on **Apply** button to apply the changes after the web browser refreshed taken you back to the VLAN page.

Port-based VLAN List
Add
Delete

Name	VLAN ID	VLAN Tagging	NAT / Bridge	Port Members	LAN IP Address	Subnet Mask	Joined WAN	WAN VID	Enable	Actions
DMZ	4094	X	NAT	DMZ Port	192.168.6.254	255.255.255.0	WAN - 1	0	<input checked="" type="checkbox"/>	Edit
LAN	Native VLAN	X	NAT	Detail	192.168.123.254	255.255.255.0	All WANs	0	<input checked="" type="checkbox"/>	Edit
VLAN-1	2	X	NAT	Detail	192.168.2.254	255.255.255.0	All WANs	0	<input checked="" type="checkbox"/>	Edit Select

Apply
Inter VLAN Group Routing

Please Click Apply button to take effect.

# 4G IIoT Gateway

## Port-based VLAN – Inter VLAN Group Routing

Click **VLAN Group Routing** button, the **VLAN Group Internet Access Definition** and **Inter VLAN Group Routing** screen will appear.

VLAN Group Internet Access Definition		
VLAN IDs	Members	Internet Access(WAN)
1	Port : 2,3,4 ; VAP : 1,2,3,4,5,6,7,8	Allow <input type="button" value="Edit"/>

Inter VLAN Group Routing		
VLAN IDs	Members	Action
		<input type="button" value="Edit"/>
		<input type="button" value="Edit"/>
		<input type="button" value="Edit"/>
		<input type="button" value="Edit"/>

When **Edit** button is applied, a screen similar to this will appear.

VLAN Group Internet Access Definition		
VLAN IDs	Members	Internet Access(WAN)
<input checked="" type="checkbox"/> 1, <input checked="" type="checkbox"/> 2	Port : 2,3,4 ; VAP : 1,2,3,4,5,6,7,8	Allow <input type="button" value="Edit"/>

Inter VLAN Group Routing		
VLAN IDs	Members	Action
<input type="checkbox"/> 1, <input type="checkbox"/> 2		<input type="button" value="Edit"/>

Inter VLAN Group Routing		
Item	Value setting	Description
<b>VALN Group Internet Access Definition</b>	All boxes are checked by default.	By default, all boxes are checked means all <b>VLAN ID</b> members are allow to access WAN interface. If uncheck a certain <b>VLAN ID</b> box, it means the VLAN ID member can't access Internet anymore. Note: <b>VLAN ID 1</b> is available always; it is the default VLAN ID of <b>LAN</b> rule. The other <b>VLAN IDs</b> are available only when they are enabled.
<b>Inter VLAN Group Routing</b>	The box is unchecked by default.	Click the expected VLAN IDs box to enable the Inter VLAN access function. By default, members in different VLAN IDs can't access each other. The gateway supports up to 4 rules for <b>Inter VLAN Group Routing</b> . For example, if ID_1 and ID_2 are checked, it means members in VLAN ID_1 can access members of VLAN ID_2, and vice versa.
<b>Save</b>	N/A	Click the <b>Save</b> button to save the configuration

# 4G IIoT Gateway

## Tag-based VLAN – Create/Edit VLAN Rules

The **Tag-based VLAN** allows you to customize each LAN port according to VLAN ID. There is a default rule shows the configuration of all LAN ports and all VAPs. Also, if your device has a DMZ port, you will see DMZ configuration, too. The router supports up to a maximum of 128 tag-based VLAN rule sets.

Tag-based VLAN List					
VLAN ID	Internet	Port	VAP	DHCP Server	Actions
Native VLAN	<input checked="" type="checkbox"/>	<input checked="" type="checkbox"/> 2 <input checked="" type="checkbox"/> 3 <input checked="" type="checkbox"/> 4	<input checked="" type="checkbox"/> 1 <input checked="" type="checkbox"/> 2 <input checked="" type="checkbox"/> 3 <input checked="" type="checkbox"/> 4 <input checked="" type="checkbox"/> 5 <input checked="" type="checkbox"/> 6 <input checked="" type="checkbox"/> 7 <input checked="" type="checkbox"/> 8	DHCP 1	<input type="button" value="Edit"/> <input type="button" value="Select"/>

When **Add** button is applied, **Tag-based VLAN Configuration** screen will appear.

Tag-based VLAN Configuration	
Item	Setting
▶ VLAN ID	<input type="text" value="0"/>
▶ Internet Access	<input checked="" type="checkbox"/> Enable
▶ Port Members	Port: <input type="checkbox"/> Port-1 <input type="checkbox"/> Port-2 <input type="checkbox"/> Port-3 <input type="checkbox"/> Port-4 2.4G: <input type="checkbox"/> VAP-1 <input type="checkbox"/> VAP-2 <input type="checkbox"/> VAP-3 <input type="checkbox"/> VAP-4 <input type="checkbox"/> VAP-5 <input type="checkbox"/> VAP-6 <input type="checkbox"/> VAP-7 <input type="checkbox"/> VAP-8
▶ Bridge Interface	<input type="text" value="DHCP 1"/>
<input type="button" value="Save"/>	

Tag-based VLAN Configuration (Part-I)		
Item	Value setting	Description
<b>VALN ID</b>	A Must filled setting	Define the <b>VLAN ID</b> number, that is outside the system reserved range. <b>Value Range:</b> 1 ~ 4095.
<b>Internet Access</b>	The box is checked by default.	Click <b>Enable</b> box to allow the members in the VLAN group access to internet.
<b>Port Members</b>	The boxes are unchecked by default.	Check the LAN port box(es) to join the VLAN group. Check the VAP box(es) to join the VLAN group. Note: Only the wireless gateway has the VAP list.
<b>Bridge Interface</b>	<b>DHCP 1</b> is selected by default.	Select a predefined <b>DHCP Server</b> , a <b>New</b> to defined a new DHCP server for these members of this VLAN group.
<b>Save</b>	N/A	Click <b>Save</b> button to save the configuration Note: After clicking <b>Save</b> button, always click <b>Apply</b> button to apply the settings.

If you select New to create a new DHCP server setting for the VLAN group, you have to further specify the following configuration.

# 4G IIoT Gateway

▶ IP Address	<input type="text"/>
▶ Subnet Mask	255.255.255.0 (/24) ▼
▶ DHCP Relay	<input type="checkbox"/> Enable & Server IP : <input type="text"/>
▶ WAN Interface	WAN - 1 ▼
▶ DHCP Relay Option 82	<input type="checkbox"/> Enable
<input type="button" value="Save"/>	

Tag-based VLAN Configuration (part-II)		
Item	Value setting	Description
<b>IP Address</b>	A Must filled setting	Assign an <b>IP Address</b> for the DHCP Server that the rule used, this IP address is a gateway IP.
<b>Subnet Mask</b>	<b>255.255.255.0(/24)</b> is selected by default.	Select a <b>Subnet Mask</b> for the DHCP Server.
<b>DHCP Relay</b>	The box is unchecked by default.	Check the box to enable the DHCP Relay function for the VLAN group, and you only need to fill the <b>DHCP Server IP Address</b> field.
<b>WAN Interface</b>	<b>WAN-1</b> is selected by default.	Select which <b>WAN</b> interface that allow accessing Internet.
<b>DHCP Option 82</b>	An Optional filled setting	If you select <b>Relay</b> type of DHCP Server, you can further enable the DHCP Option 82 setting if the DHCP server support it.
<b>Save</b>	NA	Click the <b>Save</b> button to save the configuration
<b>Undo</b>	NA	Click the <b>Undo</b> button to restore what you just configured back to the previous setting.

## Tag-based VLAN Summary

The configured tag-based VLAN group information will be displayed in the following screen.

Tag-based VLAN Summary	
Port	VLAN IDs
Port1	Native VLAN
Port2	Native VLAN
Port3	Native VLAN
Port4	Native VLAN

# 4G IIoT Gateway

## 2.2.3 DHCP Server

### ➤ DHCP Server

The gateway supports up to 4 DHCP servers to fulfill the DHCP requests from different VLAN groups (please refer to VLAN section for getting more usage details). And there is one default setting for whose LAN IP Address is the same one of gateway LAN interface, with its default Subnet Mask setting as “255.255.255.0”, and its default IP Pool ranges is from “.100” to “.200” as shown at the DHCP Server List page on gateway’s WEB UI.

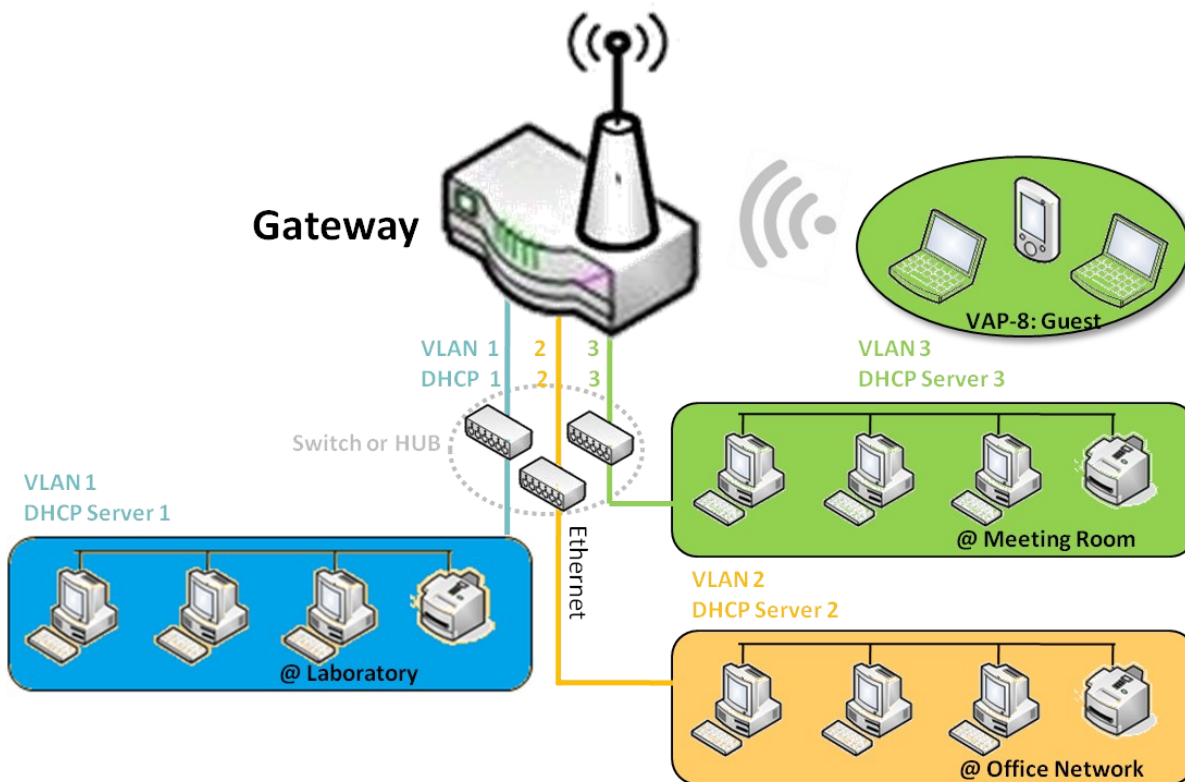

User can add more DHCP server configurations by clicking on the “Add” button behind “DHCP Server List”, or clicking on the “Edit” button at the end of each DHCP Server on list to edit its current settings. Besides, user can select a DHCP Server and delete it by clicking on the “Select” check-box and the “Delete” button.

# 4G IIoT Gateway

## ➤ Fixed Mapping

User can assign fixed IP address to map the specific client MAC address by select them then copy, when targets were already existed in the **DHCP Client List**, or to add some other Mapping Rules by manually in advance, once the target's MAC address was not ready to connect.

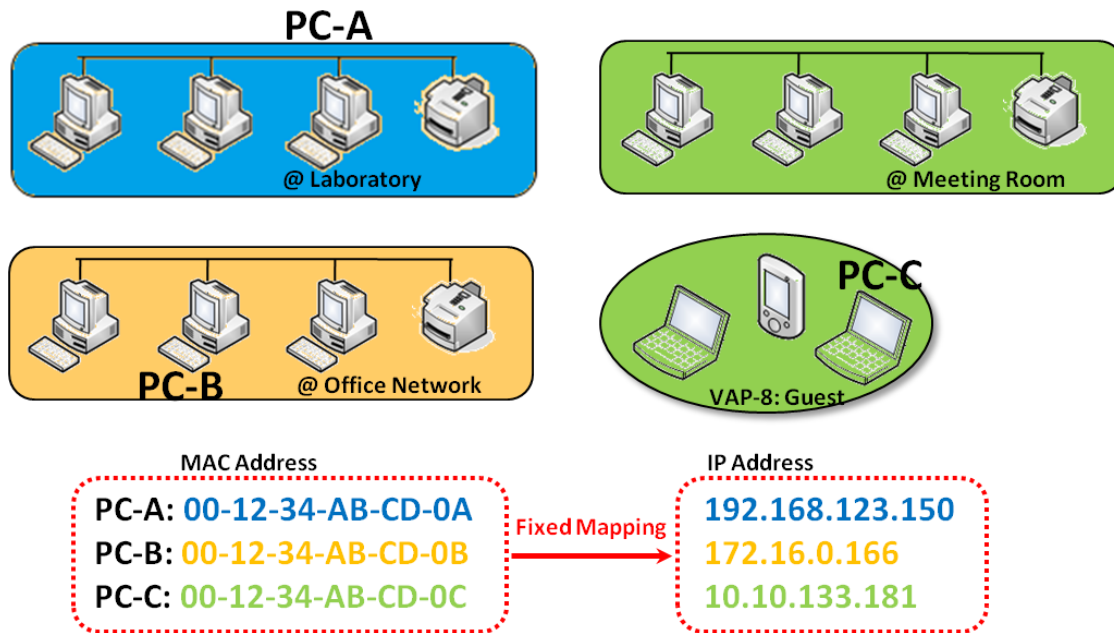

# 4G IIoT Gateway

## DHCP Server Setting

Go to **Basic Network > LAN & VLAN > DHCP Server** Tab.

The DHCP Server setting allows user to create and customize DHCP Server policies to assign IP Addresses to the devices on the local area network (LAN).

### Create / Edit DHCP Server Policy

The gateway allows you to custom your DHCP Server Policy. If multiple LAN ports are available, you can define one policy for each LAN (or VLAN group), and it supports up to a maximum of 4 policy sets.

DHCP Server List <input type="button" value="Add"/> <input type="button" value="Delete"/> DHCP Client List <span style="float: right;">[ Help ]</span>												
DHCP Server Name	LAN IP Address	Subnet Mask	IP Pool	Lease Time	Domain Name	Primary DNS	Secondary DNS	Primary WINS	Secondary WINS	Gateway	Enable	Actions
DHCP 1	192.168.123.254	255.255.255.0	192.168.123.100-192.168.123.200	3600		0.0.0.0	0.0.0.0	0.0.0.0	0.0.0.0	0.0.0.0	<input checked="" type="checkbox"/>	<input type="button" value="Edit"/> <input type="button" value="Fixed Mapping"/>

When **Add** button is applied, **DHCP Server Configuration** screen will appear.

DHCP Server Configuration	
Item	Setting
▶ DHCP Server Name	<input type="text" value="DHCP 2"/>
▶ LAN IP Address	<input type="text" value="192.168.2.254"/>
▶ Subnet Mask	<input type="text" value="255.0.0.0 (/8)"/> ▼
▶ IP Pool	Starting Address: <input type="text"/> Ending Address: <input type="text"/>
▶ Lease Time	<input type="text" value="86400"/> seconds
▶ Domain Name	<input type="text"/> (Optional)
▶ Primary DNS	<input type="text"/> (Optional)
▶ Secondary DNS	<input type="text"/> (Optional)
▶ Primary WINS	<input type="text"/> (Optional)
▶ Secondary WINS	<input type="text"/> (Optional)
▶ Gateway	<input type="text"/> (Optional)
▶ Server	<input type="checkbox"/> Enable

# 4G IIoT Gateway

DHCP Server Configuration		
Item	Value setting	Description
<b>DHCP Server Name</b>	1. String format can be any text 2. A Must filled setting	Enter a DHCP Server name. Enter a name that is easy for you to understand.
<b>LAN IP Address</b>	1. IPv4 format. 2. A Must filled setting	The LAN IP Address of this DHCP Server.
<b>Subnet Mask</b>	255.0.0.0 (/8) is set by default	The Subnet Mask of this DHCP Server.
<b>IP Pool</b>	1. IPv4 format. 2. A Must filled setting	The IP Pool of this DHCP Server. It composed of Starting Address entered in this field and Ending Address entered in this field.
<b>Lease Time</b>	1. Numeric string format. 2. A Must filled setting	The Lease Time of this DHCP Server. <b>Value Range: 300 ~ 604800 seconds.</b>
<b>Domain Name</b>	String format can be any text	The Domain Name of this DHCP Server.
<b>Primary DNS</b>	IPv4 format	The Primary DNS of this DHCP Server.
<b>Secondary DNS</b>	IPv4 format	The Secondary DNS of this DHCP Server.
<b>Primary WINS</b>	IPv4 format	The Primary WINS of this DHCP Server.
<b>Secondary WINS</b>	IPv4 format	The Secondary WINS of this DHCP Server.
<b>Gateway</b>	IPv4 format	The Gateway of this DHCP Server.
<b>Server</b>	The box is unchecked by default.	Click <b>Enable</b> box to activate this DHCP Server.
<b>Save</b>	N/A	Click the <b>Save</b> button to save the configuration
<b>Undo</b>	N/A	Click the <b>Undo</b> button to restore what you just configured back to the previous setting.
<b>Back</b>	N/A	When the <b>Back</b> button is clicked the screen will return to the DHCP Server Configuration page.

## Create / Edit Mapping Rule List on DHCP Server

The gateway allows you to custom your Mapping Rule List on DHCP Server. It supports up to a maximum of 64 rule sets. When **Fix Mapping** button is applied, the **Mapping Rule List** screen will appear.

Mapping Rule List <span>Add</span> <span>Delete</span> <span>[ Help ]</span>			
MAC Address	IP Address	Enable	Actions

When **Add** button is applied, **Mapping Rule Configuration** screen will appear.

# 4G IIoT Gateway

Mapping Rule Configuration	
Item	Setting
▶ MAC Address	<input type="text"/>
▶ IP Address	<input type="text"/>
▶ Rule	<input type="checkbox"/> Enable

Mapping Rule Configuration		
Item	Value setting	Description
<b>MAC Address</b>	1. MAC Address string format 2. A Must filled setting	The MAC Address of this mapping rule.
<b>IP Address</b>	1. IPv4 format. 2. A Must filled setting	The IP Address of this mapping rule.
<b>Rule</b>	The box is unchecked by default.	Click <b>Enable</b> box to activate this rule.
<b>Save</b>	N/A	Click the <b>Save</b> button to save the configuration
<b>Undo</b>	N/A	Click the <b>Undo</b> button to restore what you just configured back to the previous setting.
<b>Back</b>	N/A	When the <b>Back</b> button is clicked the screen will return to the <b>DHCP Server Configuration</b> page.

## View / Copy DHCP Client List

When **DHCP Client List** button is applied, **DHCP Client List** screen will appear.

DHCP Client List <span>Copy to Fixed Mapping</span>					
LAN Interface	IP Address	Host Name	MAC Address	Remaining Lease Time	Actions
Ethernet	Dynamic /192.168.123.100	James-P45V	74:D0:2B:62:8D:42	00:49:07	<input type="checkbox"/> Select

When the DHCP Client is selected and **Copy to Fixed Mapping** button is applied. The IP and MAC address of DHCP Client will apply to the Mapping Rule List on specific DHCP Server automatically.

## Enable / Disable DHCP Server Options

The **DHCP Server Options** setting allows user to set **DHCP OPTIONS 66, 72, or 114**. Click the **Enable** button to activate the DHCP option function, and the DHCP Server will add the expected options in its sending out DHCPOFFER DHCPACK packages.

# 4G IIoT Gateway

Option	Meaning	RFC
66	TFTP server name	<a href="#">[RFC 2132]</a>
72	Default World Wide Web Server	<a href="#">[RFC 2132]</a>
114	URL	<a href="#">[RFC 3679]</a>

Configuration	
Item	Setting
▶ DHCP Server Options	<input type="checkbox"/> Enable

## Create / Edit DHCP Server Options

The gateway supports up to a maximum of 99 option settings.

DHCP Server Option List <span>Add</span> <span>Delete</span>							
ID	Option Name	DHCP Sever Select	Option Select	Type	Value	Enable	Actions

When **Add/Edit** button is applied, **DHCP Server Option Configuration** screen will appear.

DHCP Server Option Configuration <span>Save</span> <span>Undo</span>	
Item	Setting
Option Name	<input type="text" value="Option 1"/>
DHCP Sever Select	<input type="text" value="DHCP 1"/>
Option Select	<input type="text" value="DHCP OPTION 66"/>
Type	<input type="text" value="Single IP Address"/>
Value	<input type="text"/>
Enable	<input type="checkbox"/> Enable

DHCP Server Option Configuration		
Item	Value setting	Description
<b>Option Name</b>	<ol style="list-style-type: none"> <li>String format can be any text</li> <li>A Must filled setting.</li> </ol>	Enter a DHCP Server Option name. Enter a name that is easy for you to understand.
<b>DHCP Server Select</b>	Dropdown list of all available DHCP servers.	Choose the DHCP server this option should apply to.
<b>Option Select</b>	<ol style="list-style-type: none"> <li>A Must filled setting.</li> <li><b>Option 66</b> is selected by default.</li> </ol>	Choose the specific option from the dropdown list. It can be <b>Option 66, Option 72, Option 144, Option 42, Option 150, or Option 160.</b> <b>Option 42</b> for ntp server; <b>Option 66</b> for tftp; <b>Option 72</b> for www;

# 4G IIoT Gateway

		<b>Option 144</b> for url;														
<b>Type</b>	Dropdown list of DHCP server option value's type	Each different options has different value types.														
		66	Single IP Address													
			Single FQDN													
		72	IP Addresses List, separated by “,”													
		114	Single URL													
		42	IP Addresses List, separated by “,”													
		150	IP Addresses List, separated by “,”													
		160	Single IP Address													
		Single FQDN														
<b>Value</b>	<ol style="list-style-type: none"> <li>1. IPv4 format</li> <li>2. FQDN format</li> <li>3. IP list</li> <li>4. URL format</li> <li>5. A Must filled setting</li> </ol>	Should conform to Type :														
			<table border="1"> <thead> <tr> <th>Type</th> <th>Value</th> </tr> </thead> <tbody> <tr> <td rowspan="2">66</td> <td>Single IP Address</td> <td>IPv4 format</td> </tr> <tr> <td>Single FQDN</td> <td>FQDN format</td> </tr> <tr> <td>72</td> <td>IP Addresses List, separated by “,”</td> <td>IPv4 format, separated by “,”</td> </tr> <tr> <td>114</td> <td>Single URL</td> <td>URL format</td> </tr> </tbody> </table>	Type	Value	66	Single IP Address	IPv4 format	Single FQDN	FQDN format	72	IP Addresses List, separated by “,”	IPv4 format, separated by “,”	114	Single URL	URL format
		Type	Value													
		66	Single IP Address	IPv4 format												
			Single FQDN	FQDN format												
72	IP Addresses List, separated by “,”	IPv4 format, separated by “,”														
114	Single URL	URL format														
<b>Enable</b>	The box is unchecked by default.	Click <b>Enable</b> box to activate this setting.														
<b>Save</b>	NA	Click the <b>Save</b> button to save the setting.														
<b>Undo</b>	NA	When the <b>Undo</b> button is clicked the screen will return back with nothing changed.														

## Create / Edit DHCP Relay

The gateway supports up to a maximum of 6 DHCP Relay configurations.

DHCP Relay Configuration List							Add	Delete
ID	Agent Name	LAN interface	WAN interface	Server IP	Enable	Actions		

When **Add/Edit** button is applied, **DHCP Relay Configuration** screen will appear.

DHCP Relay Configuration		Save	Undo
Item	Setting		
Agent Name	<input type="text"/>		
LAN interface	LAN ▼		
WAN interface	WAN - 1 ▼		
Server IP	<input type="text"/>		
DHCP OPTION 82	<input type="checkbox"/>		
Enable	<input type="checkbox"/>		

# 4G IIoT Gateway

DHCP Relay Configuration		
Item	Value setting	Description
<b>Agent Name</b>	<ol style="list-style-type: none"> <li>String format can be any text</li> <li>A Must filled setting.</li> </ol>	Enter a DHCP Relay name. Enter a name that is easy for you to understand. <b><u>Value Range:</u></b> 1~64 characters.
<b>LAN Interface</b>	<ol style="list-style-type: none"> <li>A Must filled setting.</li> <li><b>LAN</b> is selected by default.</li> </ol>	Choose a LAN Interface for the dropdown list to apply with the DHCP Relay function.
<b>WAN Interface</b>	<ol style="list-style-type: none"> <li>A Must filled setting.</li> <li><b>WAN-1</b> is selected by default.</li> </ol>	Choose a WAN Interface for the dropdown list to apply with the DHCP Relay function. It can be the available WAN interface(s), and L2TP connection.
<b>Server IP</b>	<ol style="list-style-type: none"> <li>A Must filled setting.</li> <li><b>null</b> by default.</li> </ol>	Assign a <b>DHCP Server IP Address</b> that the gateway will relay the DHCP requests to the assigned DHCP server via specified WAN interface.
<b>DHCP OPTION 82</b>	The box is unchecked by default.	Click <b>Enable</b> box to activate DHCP OPTION 82 function. Option 82 is organized as a single DHCP option that contains circuit-ID information known by the relay agent. If the relayed DHCP server required the such information, you have to enable it, otherwise, just leave it as unchecked.
<b>Enable</b>	The box is unchecked by default.	Click <b>Enable</b> box to activate this setting.
<b>Save</b>	NA	Click the <b>Save</b> button to save the setting.
<b>Undo</b>	NA	When the <b>Undo</b> button is clicked the screen will return back with nothing changed.

# 4G IIoT Gateway

## 2.3 IPv6

The growth of the Internet has created a need for more addresses than are possible with IPv4. IPv6 (Internet Protocol version 6) is a version of the Internet Protocol (IP) intended to succeed IPv4, which is the protocol currently used to direct almost all Internet traffic. IPv6 also implements additional features not present in IPv4. It simplifies aspects of address assignment (stateless address auto-configuration), network renumbering and router announcements when changing Internet connectivity providers.

### 2.3.1 IPv6 Configuration

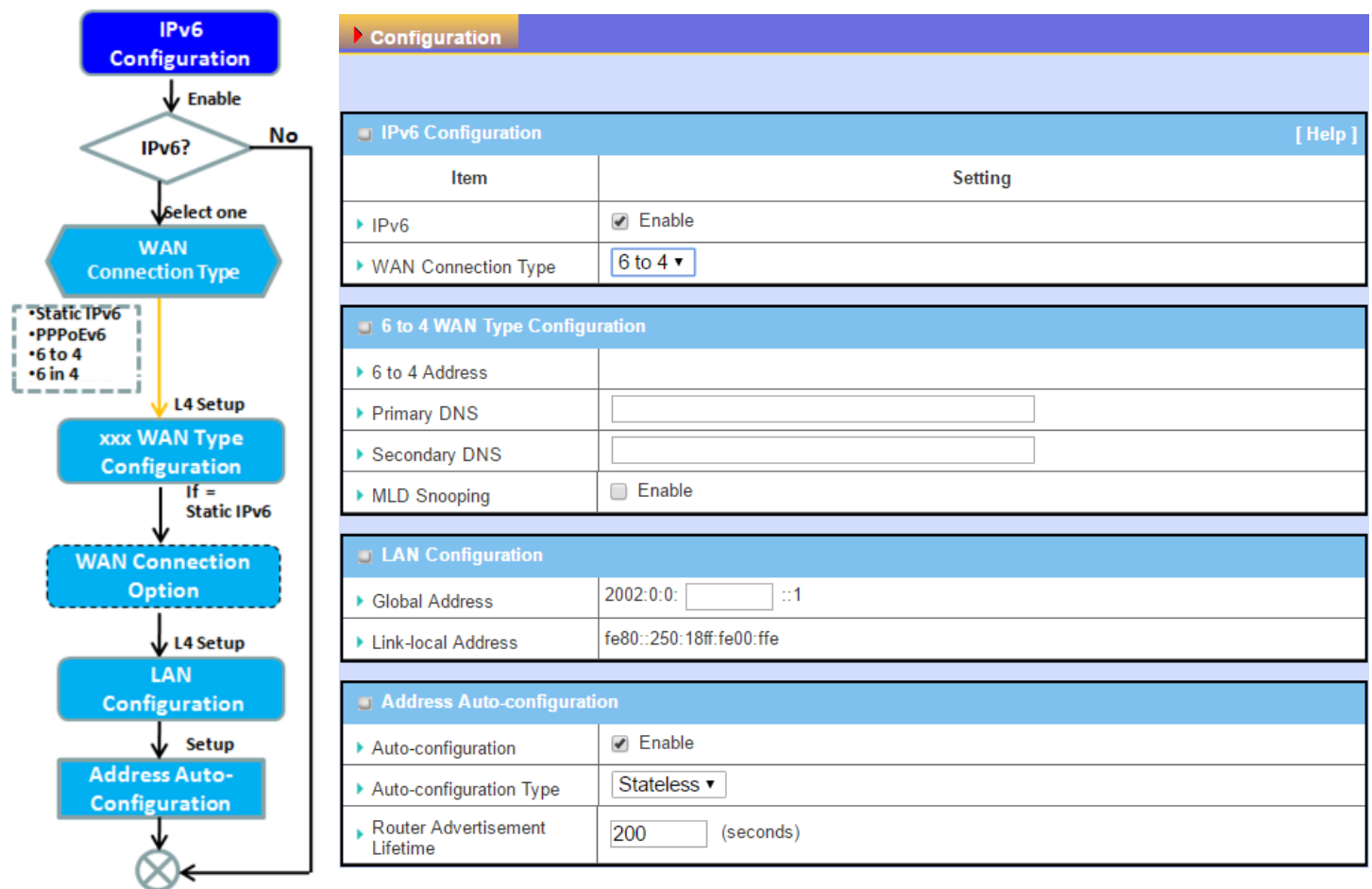

The **IPv6 Configuration** setting allows user to set the IPv6 connection type to access the IPv6 network. This gateway supports various types of IPv6 connection, including **Static IPv6**, and **PPPoEv6**

**Note:** For the products just having 3G/4G WAN interface, only **IPv6** is supported. Please contact your ISP for the IPv6 supports before you proceed with IPv6 setup.

# 4G IIoT Gateway

## IPv6 WAN Connection Type

### Static IPv6

Static IPv6 does the same function as static IPv4. The static IPv6 provides manual setting of IPv6 address, IPv6 default gateway address, and IPv6 DNS.

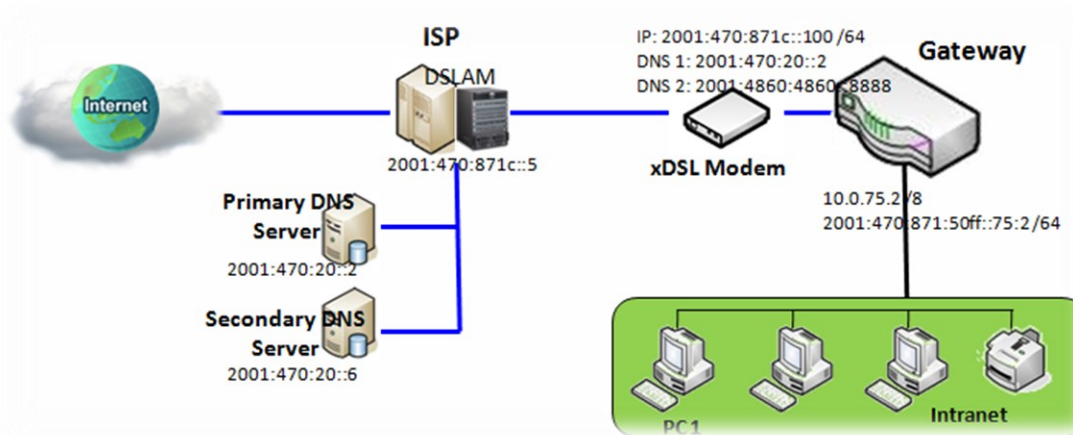

Above diagram depicts the IPv6 IP addressing, type in the information provided by your ISP to setup the IPv6 network.

### PPPoEv6

PPPoEv6 in IPv6 does the same function as PPPoE in IPv4. The PPPoEv6 server provides configuration parameters based on PPPoEv6 client request. When PPPoEv6 server gets client request and successfully authenticates it, the server sends IP address, DNS server addresses and other required parameters to automatically configure the client.

# 4G IIoT Gateway

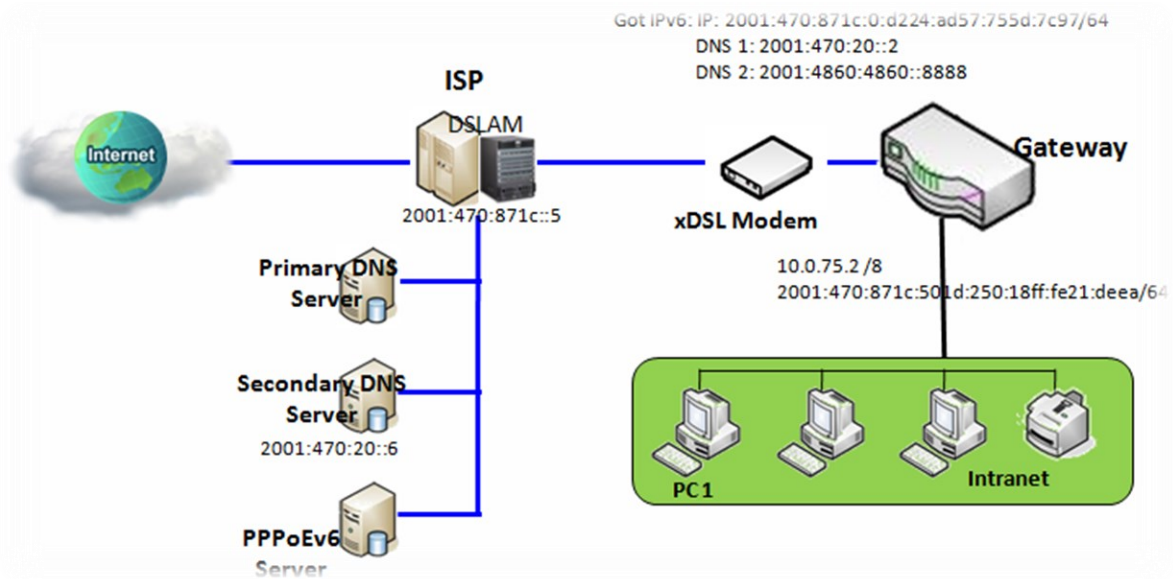

The diagram above depicts the IPv6 addressing through PPPoE, PPPoEv6 server (DSLAM) on the ISP side provides IPv6 configuration upon receiving PPPoEv6 client request. When PPPoEv6 server gets client request and successfully authenticates it, the server sends IP address, DNS server addresses and other required parameters to automatically configure the client.

# 4G IIoT Gateway

## IPv6 Configuration Setting

Go to **Basic Network > IPv6 > Configuration** Tab.

The **IPv6 Configuration** setting allows user to set the IPv6 connection type to access the IPv6 network.

Main IPv6 Configuration	
Item	Setting
▶ Main IPv6	<input checked="" type="checkbox"/> Enable
▶ WAN Connection Type	Static IPv6 ▾

Item	Value setting	Description
<b>IPv6</b>	The box is unchecked by default,	Check the <b>Enable</b> box to activate the IPv6 function.
<b>WAN Connection Type</b>	<ol style="list-style-type: none"><li>1. Only can be selected when IPv6 Enable</li><li>2. A Must filled setting</li></ol>	<p>Define the selected IPv6 WAN Connection Type to establish the IPv6 connectivity.</p> <p>Select <b>Static IPv6</b> when your ISP provides you with a set IPv6 addresses. Then go to <b>Static IPv6 WAN Type Configuration</b>.</p> <p>Select <b>PPPoEv6</b> when your ISP provides you with PPPoEv6 account settings.</p> <p>Select <b>IPv6</b> when you want to use IPv6 connection.</p> <p><b>Note:</b> For the products just having 3G/4G WAN interface, only <b>IPv6</b> is supported.</p>

## Static IPv6 WAN Type Configuration

Static IPv6 WAN Type Configuration	
▶ IPv6 Address	<input type="text"/>
▶ Subnet Prefix Length	<input type="text"/>
▶ Default Gateway	<input type="text"/>
▶ Primary DNS	<input type="text"/>
▶ Secondary DNS	<input type="text"/>
▶ MLD Snooping	<input type="checkbox"/> Enable

Item	Value setting	Description
<b>IPv6 Address</b>	A Must filled setting	Enter the WAN <b>IPv6 Address</b> for the router.
<b>Subnet Prefix</b>	A Must filled setting	Enter the WAN <b>Subnet Prefix Length</b> for the router.

# 4G IIoT Gateway

Length		
<b>Default Gateway</b>	A Must filled setting	Enter the WAN <b>Default Gateway</b> IPv6 address.
<b>Primary DNS</b>	An optional setting	Enter the WAN <b>primary DNS Server</b> .
<b>Secondary DNS</b>	An optional setting	Enter the WAN <b>secondary DNS Server</b> .
<b>MLD Snooping</b>	The box is unchecked by default	Enable/Disable the MLD Snooping function

## LAN Configuration

LAN Configuration	
▶ Global Address	<input type="text"/> /64
▶ Link-local Address	fe80::250:18ff:fe16:1123

LAN Configuration		
Item	Value setting	Description
<b>Global Address</b>	A Must filled setting	Enter the LAN <b>IPv6 Address</b> for the router.
<b>Link-local Address</b>	Value auto-created	Show the link-local address for LAN interface of router.

Then go to **Address Auto-configuration (summary)** for setting LAN environment.

If above setting is configured, click the **Save** button to save the configuration, and click the **Reboot** button to reboot the router.

# 4G IIoT Gateway

## PPPoEv6 WAN Type Configuration

PPPoEv6 WAN Type Configuration	
▶ Account	<input type="text"/>
▶ Password	<input type="text"/>
▶ Service Name	<input type="text"/>
▶ Connection Control	Auto-reconnect (Always on)
▶ MTU	<input type="text"/>
▶ MLD Snooping	<input type="checkbox"/> Enable

PPPoEv6 WAN Type Configuration		
Item	Value setting	Description
Account	A Must filled setting	Enter the Account for setting up PPPoEv6 connection. If you want more information, please contact your ISP. <b>Value Range:</b> 0 ~ 45 characters.
Password	A Must filled setting	Enter the Password for setting up PPPoEv6 connection. If you want more information, please contact your ISP.
Service Name	A Must filled setting/Option	Enter the Service Name for setting up PPPoEv6 connection. If you want more information, please contact your ISP. <b>Value Range:</b> 0 ~ 45 characters.
Connection Control	Fixed value	The value is <b>Auto-reconnect(Always on)</b> .
MTU	A Must filled setting	Enter the MTU for setting up PPPoEv6 connection. If you want more information, please contact your ISP. <b>Value Range:</b> 1280 ~ 1492.
MLD Snooping	The box is unchecked by default	Enable/Disable the MLD Snooping function

## LAN Configuration

LAN Configuration	
▶ Global Address	<input type="text"/>
▶ Link-local Address	fe80::250:18ff:fe16:1123

LAN Configuration		
Item	Value setting	Description
Global Address	Value auto-created	The LAN <b>IPv6 Address</b> for the router.
Link-local Address	Value auto-created	Show the link-local address for LAN interface of router.

Then go to **Address Auto-configuration (summary)** for setting LAN environment.

If above setting is configured, click the **save button** to save the configuration and click **reboot button** to reboot the router.

# 4G IIoT Gateway

Then go to **Address Auto-configuration (summary)** for setting LAN environment.

If above setting is configured, click the **save button** to save the configuration and click **reboot button** to reboot the router.

## Address Auto-configuration

Address Auto-configuration	
▶ Auto-configuration	<input checked="" type="checkbox"/> Enable
▶ Auto-configuration Type	Stateless ▼
▶ Router Advertisement Lifetime	<input type="text" value="200"/> (seconds)

Address Auto-configuration		
Item	Value setting	Description
<b>Auto-configuration</b>	The box is unchecked by default	Check to enable the Auto configuration feature.
<b>Auto-configuration Type</b>	1. Only can be selected when <b>Auto-configuration</b> enabled 2. Stateless is selected by default	Define the selected IPv6 WAN Connection Type to establish the IPv6 connectivity. Select <b>Stateless</b> to manage the Local Area Network to be SLAAC + RDNSS <b>Router Advertisement Lifetime</b> (A Must filled setting): Enter the Router Advertisement Lifetime (in seconds). 200 is set by default. <u>Value Range</u> : 0 ~ 65535.

# 4G IIoT Gateway

## 2.4 Port Forwarding

Network address translation (NAT) is a methodology of remapping one IP address space into another by modifying network address information in Internet Protocol (IP) datagram packet headers while they are in transit across a traffic routing device. The technique was originally used for ease of rerouting traffic in IP networks without renumbering every host. It has become a popular and essential tool in conserving global address space allocations in face of IPv4 address exhaustion. The product you purchased embeds and activates the NAT function. You also can disable the NAT function in **[Basic Network]-[WAN & Uplink]-[Internet Setup]-[WAN Type Configuration]** page.

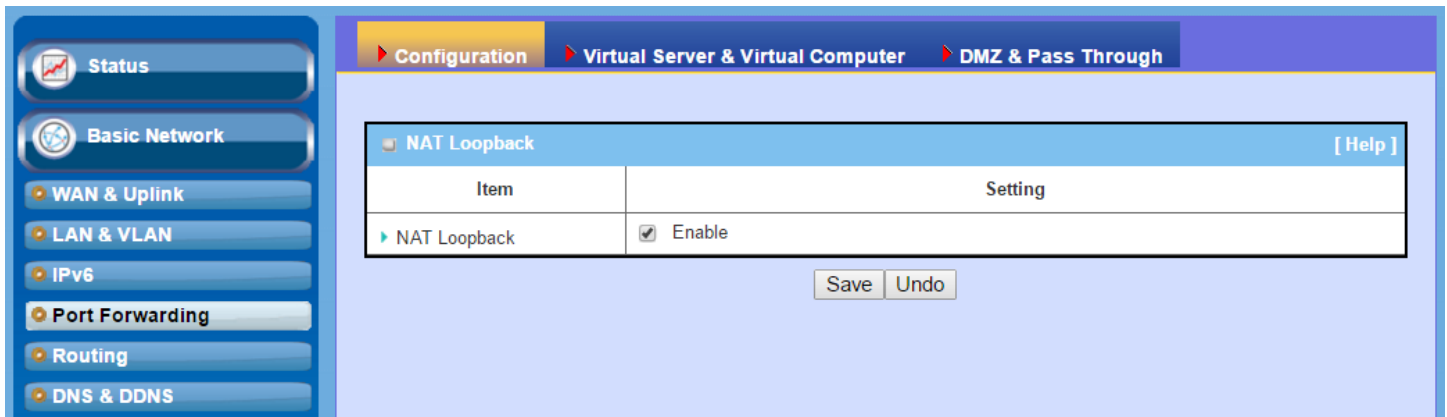

Usually all local hosts or servers behind corporate gateway are protected by NAT firewall. NAT firewall will filter out unrecognized packets to protect your Intranet. So, all local hosts are invisible to the outside world. Port forwarding or port mapping is function that redirects a communication request from one address and port number combination to assigned one. This technique is most commonly used to make services on a host residing on a protected or masqueraded (internal) network available to hosts on the opposite side of the gateway (external network), by remapping the destination IP address and port number

# 4G IIoT Gateway

## 2.4.1 Configuration

### NAT Loopback

This feature allows you to access the WAN global IP address from your inside NAT local network. It is useful when you run a server inside your network. For example, if you set a mail server at LAN side, your local devices can access this mail server through gateway's global IP address when enable NAT loopback feature. On either side are you in accessing the email server, at the LAN side or at the WAN side, you don't need to change the IP address of the mail server.

### Configuration Setting

Go to **Basic Network > Port Forwarding > Configuration** tab.

The NAT Loopback allows user to access the WAN IP address from inside your local network.

### Enable NAT Loopback

NAT Loopback <span style="float: right;">[ Help ]</span>	
Item	Setting
▶ NAT Loopback	<input checked="" type="checkbox"/> Enable

Configuration		
Item	Value setting	Description
<b>NAT Loopback</b>	The box is checked by default	Check the <b>Enable</b> box to activate this NAT function
<b>Save</b>	N/A	Click the <b>Save</b> button to save the settings.
<b>Undo</b>	N/A	Click the <b>Undo</b> button to cancel the settings

# 4G IIoT Gateway

## 2.4.2 Virtual Server & Virtual Computer

Configuration	
Item	Setting
▶ Virtual Server	<input checked="" type="checkbox"/> Enable
▶ Virtual Computer	<input checked="" type="checkbox"/> Enable

Virtual Server List <input type="button" value="Add"/> <input type="button" value="Delete"/>								
ID	WAN Interface	Server IP	Protocol	Public Port	Private Port	Time Schedule	Enable	Actions
1	All	10.0.75.101	TCP(6) & UDP(17)	25	25	(0) Always	<input checked="" type="checkbox"/>	<input type="button" value="Edit"/> <input type="checkbox"/> Select
2	All	10.0.75.101	TCP(6) & UDP(17)	110	110	(0) Always	<input checked="" type="checkbox"/>	<input type="button" value="Edit"/> <input type="checkbox"/> Select

Virtual Computer List <input type="button" value="Add"/> <input type="button" value="Delete"/>				
ID	Global IP	Local IP	Enable	Actions
1	118.18.81.44	10.0.75.102	<input checked="" type="checkbox"/>	<input type="button" value="Edit"/> <input type="checkbox"/> Select

There are some important Port Forwarding functions implemented within the gateway, including "Virtual Server", "NAT loopback" and "Virtual Computer".

It is necessary for cooperate staffs who travel outside and want to access various servers behind office gateway. You can set up those servers by using "Virtual Server" feature. After trip, if want to access those servers from LAN side by global IP, without change original setting, NAT Loopback can achieve it.

"Virtual computer" is a host behind NAT gateway whose IP address is a global one and is visible to the outside world. Since it is behind NAT, it is protected by gateway firewall. To configure Virtual Computer, you just have to map the local IP of the virtual computer to a global IP.

# 4G IIoT Gateway

## Virtual Server & NAT Loopback

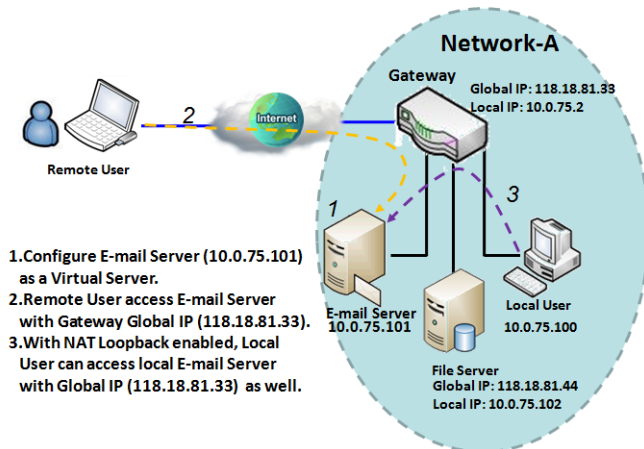

"Virtual Server" allows you to access servers with the global IP address or FQDN of the gateway as if they are servers existed in the Internet. But in fact, these servers are located in the Intranet and are physically behind the gateway. The gateway serves the service requests by port forwarding the requests to the LAN servers and transfers the replies from LAN servers to the requester on the WAN side. As shown in example, an E-mail virtual server is defined to be located at a server with IP address 10.0.75.101 in the Intranet of Network-A, including SMTP service port 25 and POP3 service port 110. So, the remote user can access the E-mail server with the

gateway's global IP 118.18.81.33 from its WAN side. But the real E-mail server is located at LAN side and the gateway is the port forwarder for E-mail service.

NAT Loopback allows you to access the WAN global IP address from your inside NAT local network. It is useful when you run a server inside your network. For example, if you set a mail server at LAN side, your local devices can access this mail server through gateway's global IP address when enable NAT loopback feature. On either side are you in accessing the email server, at the LAN side or at the WAN side, you don't need to change the IP address of the mail server.

## Virtual Computer

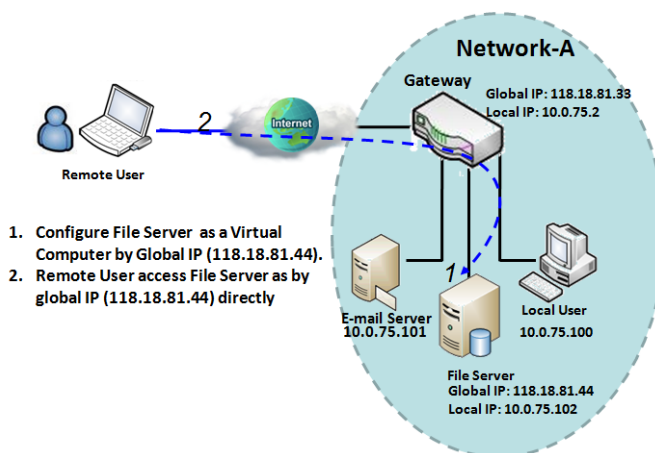

"Virtual Computer" allows you to assign LAN hosts to global IP addresses, so that they can be visible to outside world. While so, they are also protected by the gateway firewall as being client hosts in the Intranet. For example, if you set a FTP file server at LAN side with local IP address 10.0.75.102 and global IP address 118.18.82.44, a remote user can access the file server while it is hidden behind the NAT gateway. That is because the gateway takes care of all accessing to the IP address 118.18.82.44, including to forward the access requests to the file server and to send the replies from the server to outside world.

# 4G IIoT Gateway

## Virtual Server & Virtual Computer Setting

Go to **Basic Network > Port Forwarding > Virtual Server & Virtual Computer** tab.

### Enable Virtual Server and Virtual Computer

Configuration	
Item	Setting
▶ Virtual Server	<input checked="" type="checkbox"/> Enable
▶ Virtual Computer	<input checked="" type="checkbox"/> Enable

Configuration Item	Value setting	Description
<b>Virtual Server</b>	The box is unchecked by default	Check the <b>Enable</b> box to activate this port forwarding function
<b>Virtual Computer</b>	The box is checked by default	Check the <b>Enable</b> box to activate this port forwarding function
<b>Save</b>	N/A	Click the <b>Save</b> button to save the settings.
<b>Undo</b>	N/A	Click the <b>Undo</b> button to cancel the settings.

### Create / Edit Virtual Server

The gateway allows you to custom your Virtual Server rules. It supports up to a maximum of 20 rule-based Virtual Server sets.

Virtual Server List <input type="button" value="Add"/> <input type="button" value="Delete"/>								
ID	WAN Interface	Server IP	Protocol	Public Port	Private Port	Time Schedule	Enable	Actions

When **Add** button is applied, **Virtual Server Rule Configuration** screen will appear.

# 4G IIoT Gateway

Virtual Server Rule Configuration	
Item	Setting
▶ WAN Interface	<input checked="" type="checkbox"/> All <input type="checkbox"/> WAN-1 <input type="checkbox"/> WAN-2 <input type="checkbox"/> WAN-3 <input type="checkbox"/> WAN-4
▶ Server IP	<input type="text"/>
▶ Protocol	TCP(6) & UDP(17) ▼
▶ Public Port	Single Port ▼ <input type="text"/>
▶ Private Port	Single Port ▼ <input type="text"/>
▶ Time Schedule	(0) Always ▼
▶ Rule	<input type="checkbox"/> Enable

Virtual Server Rule Configuration		
Item	Value setting	Description
<b>WAN Interface</b>	1. A Must filled setting 2. Default is <b>ALL</b> .	<p>Define the selected interface to be the packet-entering interface of the gateway.</p> <p>If the packets to be filtered are coming from <b>WAN-x</b> then select <b>WAN-x</b> for this field.</p> <p>Select <b>ALL</b> for packets coming into the gateway from any interface. It can be selected <b>WAN-x</b> box when <b>WAN-x</b> enabled.</p> <p><b>Note:</b> The available check boxes (<b>WAN-1 ~ WAN-4</b>) depend on the number of WAN interfaces for the product.</p>
<b>Server IP</b>	A Must filled setting	This field is to specify the IP address of the interface selected in the WAN Interface setting above.
<b>Protocol</b>	A Must filled setting	<p>When “<b>ICMPv4</b>” is selected It means the option “Protocol” of packet filter rule is ICMPv4. Apply <b>Time Schedule</b> to this rule, otherwise leave it as <b>Always</b>. (refer to <b>Scheduling setting</b> under <b>Object Definition</b>) Then check <b>Enable</b> box to enable this rule.</p> <p>When “<b>TCP</b>” is selected It means the option “Protocol” of packet filter rule is TCP. <b>Public Port</b> selected a predefined port from <b>Well-known Service</b>, and <b>Private Port</b> is the same with <b>Public Port</b> number. <b>Public Port</b> is selected <b>Single Port</b> and specify a port number, and <b>Private Port</b> can be set a <b>Single Port</b> number. <b>Public Port</b> is selected <b>Port Range</b> and specify a port range, and <b>Private Port</b> can be selected <b>Single Port</b> or <b>Port Range</b>. <u>Value Range</u>: 1 ~ 65535 for Public Port, Private Port.</p> <p>When “<b>UDP</b>” is selected It means the option “Protocol” of packet filter rule is UDP. <b>Public Port</b> selected a predefined port from <b>Well-known Service</b>, and <b>Private</b></p>

# 4G IIoT Gateway

**Port** is the same with **Public Port** number.  
**Public Port** is selected **Single Port** and specify a port number, and **Private Port** can be set a **Single Port** number.  
**Public Port** is selected **Port Range** and specify a port range, and **Private Port** can be selected **Single Port** or **Port Range**.  
Value Range: 1 ~ 65535 for Public Port, Private Port.

When **“TCP & UDP”** is selected  
It means the option “Protocol” of packet filter rule is TCP and UDP.  
**Public Port** selected a predefined port from **Well-known Service**, and **Private Port** is the same with **Public Port** number.  
**Public Port** is selected **Single Port** and specify a port number, and **Private Port** can be set a **Single Port** number.  
**Public Port** is selected **Port Range** and specify a port range, and **Private Port** can be selected **Single Port** or **Port Range**.  
Value Range: 1 ~ 65535 for Public Port, Private Port.

When **“GRE”** is selected  
It means the option “Protocol” of packet filter rule is GRE.

When **“ESP”** is selected  
It means the option “Protocol” of packet filter rule is ESP.

When **“SCTP”** is selected  
It means the option “Protocol” of packet filter rule is SCTP.

When **“User-defined”** is selected  
It means the option “Protocol” of packet filter rule is User-defined.  
For **Protocol Number**, enter a port number.

<b>Time Schedule</b>	1. An optional filled setting 2. <b>(0)Always</b> Is selected by default.	Apply Time Schedule to this rule; otherwise leave it as (0)Always. (refer to Scheduling setting under Object Definition)
<b>Rule</b>	1. An optional filled setting 2. The box is unchecked by default.	Check the Enable box to activate the rule.
<b>Save</b>	N/A	Click the <b>Save</b> button to save the settings.
<b>Undo</b>	N/A	Click the <b>Undo</b> button to cancel the settings.
<b>Back</b>	N/A	When the <b>Back</b> button is clicked the screen will return to previous page.

# 4G IIoT Gateway

## Create / Edit Virtual Computer

The gateway allows you to custom your Virtual Computer rules. It supports up to a maximum of 20 rule-based Virtual Computer sets.

Virtual Computer List <input type="button" value="Add"/> <input type="button" value="Delete"/>				
ID	Global IP	Local IP	Enable	Actions

When **Add** button is applied, **Virtual Computer Rule Configuration** screen will appear.

Virtual Computer Rule Configuration <span style="float: right;">[ Help ]</span>		
Global IP	Local IP	Enable
<input type="text"/>	<input type="text"/>	<input type="checkbox"/>
<input type="button" value="Save"/>		

Virtual Computer Rule Configuration		
Item	Value setting	Description
<b>Global IP</b>	A Must filled setting	This field is to specify the IP address of the WAN IP.
<b>Local IP</b>	A Must filled setting	This field is to specify the IP address of the LAN IP.
<b>Enable</b>	N/A	Then check <b>Enable</b> box to enable this rule.
<b>Save</b>	N/A	Click the <b>Save</b> button to save the settings.

# 4G IIoT Gateway

## 2.4.3 DMZ & Pass Through

DMZ (De Militarized Zone) Host is a host that is exposed to the Internet cyberspace but still within the protection of firewall by gateway device. So, the function allows a computer to execute 2-way communication for Internet games, Video conferencing, Internet telephony and other special applications. In some cases when a specific application is blocked by NAT mechanism, you can indicate that LAN computer as a DMZ host to solve this problem.

The DMZ function allows you to ask the gateway pass through all normal packets to the DMZ host behind the NAT gateway only when these packets are not expected to receive by applications in the gateway or by other client hosts in the Intranet. Certainly, the DMZ host is also protected by the gateway firewall. Activate the feature and specify the DMZ host with a host in the Intranet when needed.

Configuration <span style="float: right;">[ Help ]</span>	
Item	Setting
DMZ	<input checked="" type="checkbox"/> Enable <input checked="" type="checkbox"/> All <input type="checkbox"/> WAN-1 <input type="checkbox"/> WAN-2 DMZ Host : <input type="text" value="10.0.75.100"/>
Pass Through Enable	<input checked="" type="checkbox"/> IPSec <input checked="" type="checkbox"/> PPTP <input checked="" type="checkbox"/> L2TP

### DMZ Scenario

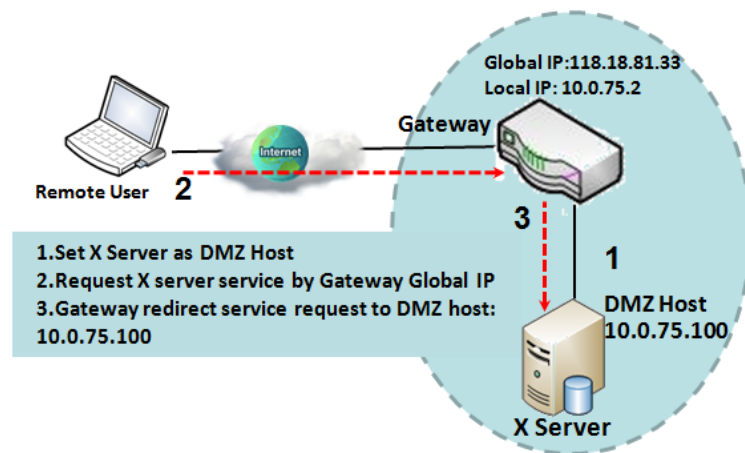

When the network administrator wants to set up some service daemons in a host behind NAT gateway to allow remote users request for services from server actively, you just have to configure this host as DMZ Host. As shown in the diagram, there is an X server installed as DMZ host, whose IP address is 10.0.75.100. Then, remote user can request services from X server just as it is provided by the gateway whose global IP address is 118.18.81.33. The gateway will forward those packets, not belonging to any configured virtual server or applications, directly to the DMZ host.

# 4G IIoT Gateway

## VPN Pass through Scenario

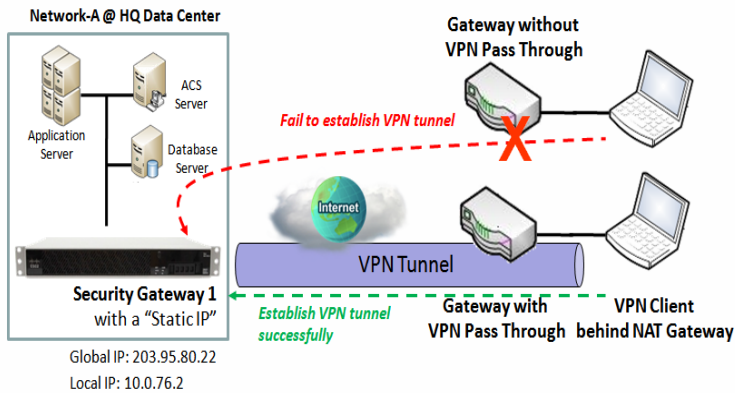

Since VPN traffic is different from that of TCP or UDP connection, it will be blocked by NAT gateway. To support the pass through function for the VPN connections initiating from VPN clients behind NAT gateway, the gateway must implement some kind of VPN pass through function for such application. The gateway support the pass through function for IPSec, PPTP, and L2TP connections, you just have to check the corresponding checkbox to activate it.

## DMZ & Pass Through Setting

Go to **Basic Network > Port Forwarding > DMZ & Pass Through** tab.

The DMZ host is a host that is exposed to the Internet cyberspace but still within the protection of firewall by gateway device.

### Enable DMZ and Pass Through

Configuration [ Help ]	
Item	Setting
▶ DMZ	<input type="checkbox"/> Enable <input checked="" type="checkbox"/> All <input type="checkbox"/> WAN-1 <input type="checkbox"/> WAN-2 <input type="checkbox"/> WAN-3 <input type="checkbox"/> WAN-4 DMZ Host : <input type="text"/>
▶ Pass Through Enable	<input checked="" type="checkbox"/> IPSec <input checked="" type="checkbox"/> PPTP <input checked="" type="checkbox"/> L2TP

Configuration Item	Value setting	Description
DMZ	1. A Must filled setting 2. Default is <b>ALL</b> .	Check the <b>Enable</b> box to activate the DMZ function Define the selected interface to be the packet-entering interface of the gateway, and fill in the IP address of Host LAN IP in <b>DMZ Host</b> field . If the packets to be filtered are coming from <b>WAN-x</b> then select <b>WAN-x</b> for this field. Select <b>ALL</b> for packets coming into the router from any interfaces.

## 4G IloT Gateway

---

		It can be selected <b>WAN-x</b> box when <b>WAN-x</b> enabled.  <b>Note:</b> The available check boxes ( <b>WAN-1 ~ WAN-4</b> ) depend on the number of WAN interfaces for the product.
Pass Through Enable	The boxes are checked by default	Check the box to enable the pass through function for the <b>IPSec</b> , <b>PPTP</b> , and <b>L2TP</b> . With the pass through function enabled, the VPN hosts behind the gateway still can connect to remote VPN servers.
Save	N/A	Click the <b>Save</b> button to save the settings.
Undo	N/A	Click the <b>Undo</b> button to cancel the settings

### 2.4.4 Special AP & ALG (not supported)

Not supported feature for the purchased product, leave it as blank.

## 2.5 Routing

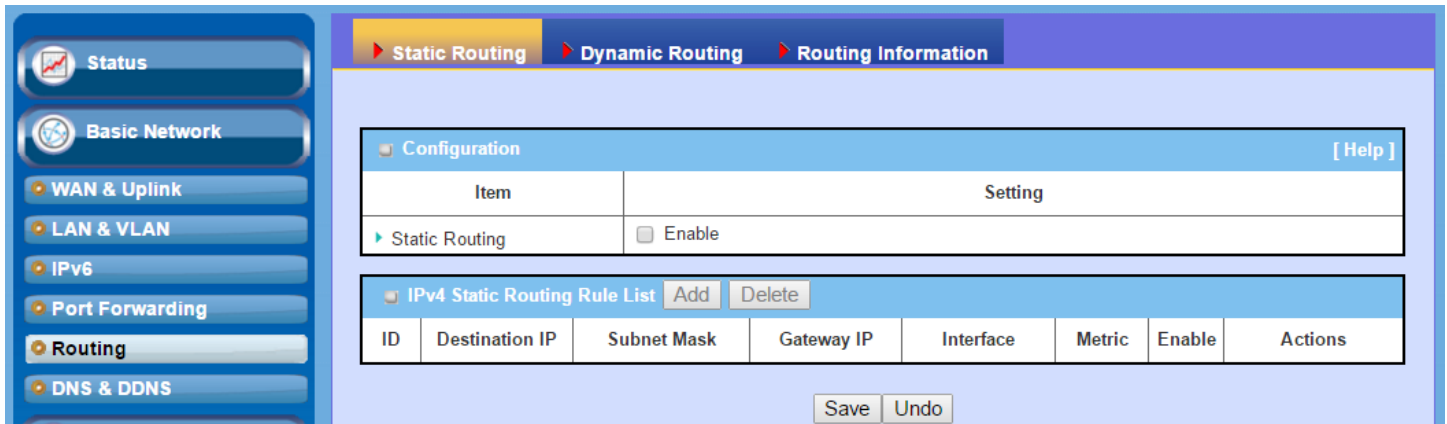

If you have more than one router and subnet, you will need to enable routing function to allow packets to find proper routing path and allow different subnets to communicate with each other. Routing is the process of selecting best paths in a network. It is performed for many kinds of networks, like electronic data networks (such as the Internet), by using packet switching technology. The routing process usually directs forwarding on the basis of routing tables which maintain a record of the routes to various network destinations. Thus, constructing routing tables, which are held in the router's memory, is very important for efficient routing. Most routing algorithms use only one network path at a time.

The routing tables record your pre-defined routing paths for some specific destination subnets. It is **static routing**. However, if the contents of routing tables record the obtained routing paths from neighbor routers by using some protocols, such as RIP, OSPF and BGP. It is **dynamic routing**. These both routing approaches will be illustrated one after one. In addition, the gateway also built in one advanced configurable routing software Quagga for more complex routing applications, you can configure it if required via Telnet CLI.

# 4G IIoT Gateway

## 2.5.1 Static Routing

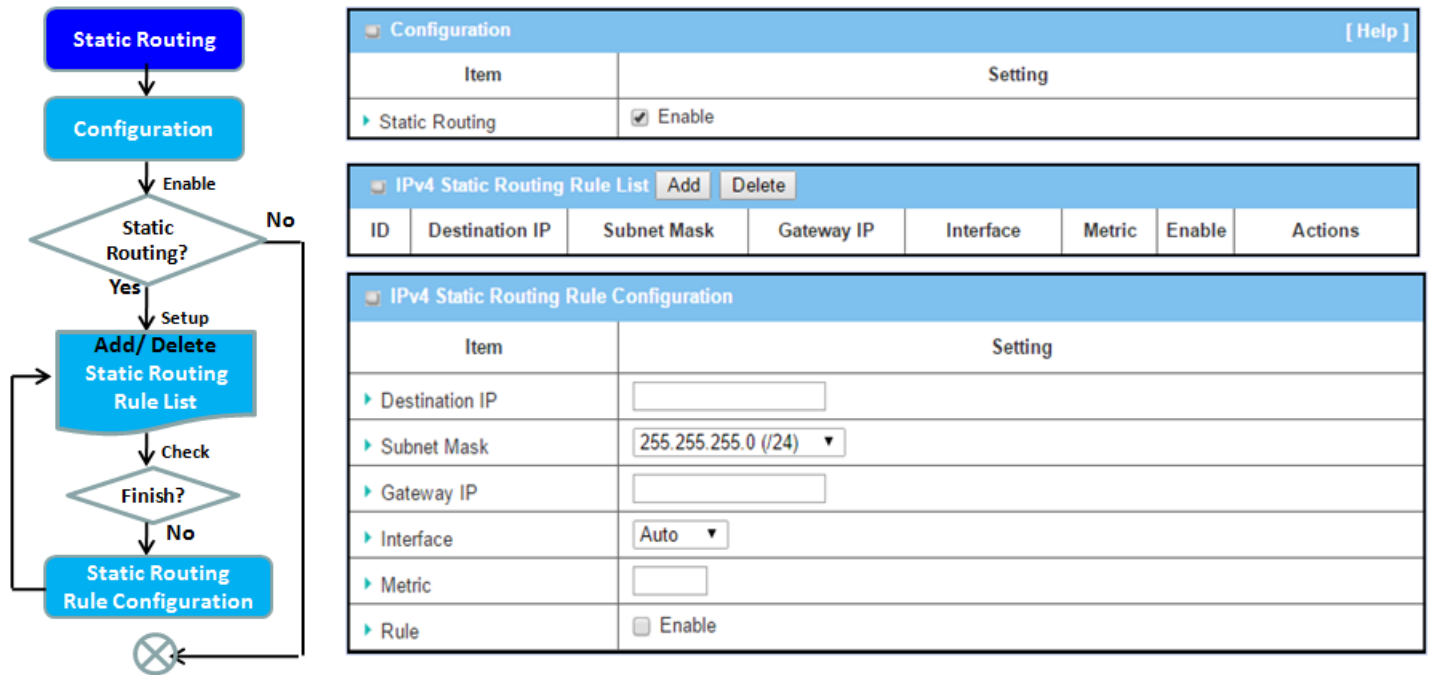

"Static Routing" function lets you define the routing paths for some dedicated hosts/servers or subnets to store in the routing table of the gateway. The gateway routes incoming packets to different peer gateways based on the routing table. You need to define the static routing information in gateway routing rule list.

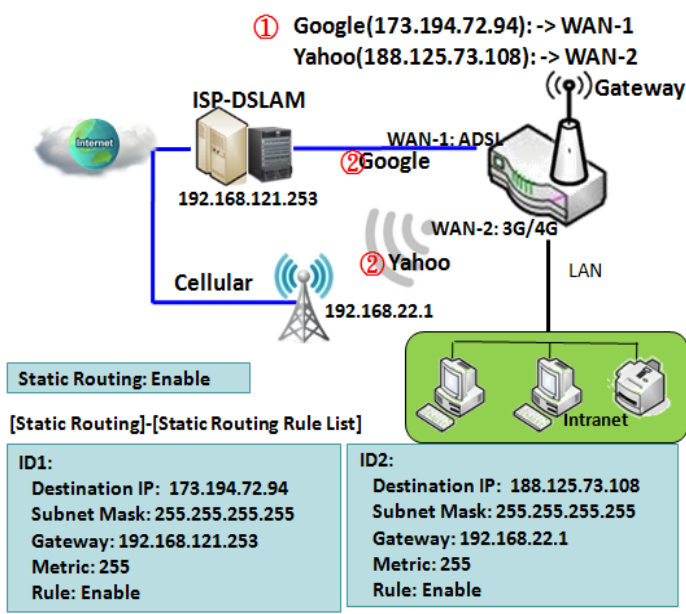

When the administrator of the gateway wants to specify what kinds of packets to be transferred via which gateway interface and which peer gateway to their destination. It can be carried out by the "Static Routing" feature. Dedicated packet flows from the Intranet will be routed to their destination via the pre-defined peer gateway and corresponding gateway interface that are defined in the system routing table by manual.

As shown in the diagram, when the destination is Google access, rule 1 set interface as ADSL, routing gateway as IP-DSLAM gateway 192.168.121.253. All the packets to Google will go through WAN-1. And the same way applied to rule 2 of access Yahoo. Rule 2 sets 3G/4G as interface.

# 4G IIoT Gateway

## Static Routing Setting

Go to **Basic Network > Routing > Static Routing** Tab.

There are three configuration windows for static routing feature, including "Configuration", "Static Routing Rule List" and "Static Routing Rule Configuration" windows. "Configuration" window lets you activate the global static routing feature. Even there are already routing rules, if you want to disable routing temporarily, just uncheck the Enable box to disable it. "Static Routing Rule List" window lists all your defined static routing rule entries. Using "Add" or "Edit" button to add and create one new static routing rule or to modify an existed one.

When "**Add**" or "**Edit**" button is applied, the "Static Routing Rule Configuration" window will appear to let you define a static routing rule.

### Enable Static Routing

Just check the **Enable** box to activate the "Static Routing" feature.

Configuration <span style="float: right;">[ Help ]</span>	
Item	Setting
▶ Static Routing	<input checked="" type="checkbox"/> Enable

Static Routing		
Item	Value setting	Description
Static Routing	The box is unchecked by default	Check the <b>Enable</b> box to activate this function

### Create / Edit Static Routing Rules

The Static Routing Rule List shows the setup parameters of all static routing rule entries. To configure a static routing rule, you must specify related parameters including the destination IP address and subnet mask of dedicated host/server or subnet, the IP address of peer gateway, the metric and the rule activation.

IPv4 Static Routing Rule List <span>Add</span> <span>Delete</span>							
ID	Destination IP	Subnet Mask	Gateway IP	Interface	Metric	Enable	Actions

The gateway allows you to custom your static routing rules. It supports up to a maximum of 64 rule sets. When **Add** button is applied, **Static Routing Rule Configuration** screen will appear, while the **Edit** button at the end

# 4G IIoT Gateway

of each static routing rule can let you modify the rule.

IPv4 Static Routing Rule Configuration	
Item	Setting
▶ Destination IP	<input type="text"/>
▶ Subnet Mask	<input type="text" value="255.255.255.0 (/24)"/> ▼
▶ Gateway IP	<input type="text"/>
▶ Interface	<input type="text" value="Auto"/> ▼
▶ Metric	<input type="text"/>
▶ Rule	<input type="checkbox"/> Enable

IPv4 Static Routing		
Item	Value setting	Description
Destination IP	1. IPv4 Format 2. A Must filled setting	Specify the Destination IP of this static routing rule.
Subnet Mask	255.255.255.0 (/24) is set by default	Specify the Subnet Mask of this static routing rule.
Gateway IP	1. IPv4 Format 2. A Must filled setting	Specify the Gateway IP of this static routing rule.
Interface	Auto is set by default	Select the Interface of this static routing rule. It can be <b>Auto</b> , or the available WAN / LAN interfaces.
<b>Metric</b>	1. Numeric String Format 2. A Must filled setting	The Metric of this static routing rule. <i>Value Range: 0 ~ 255.</i>
<b>Rule</b>	The box is unchecked by default.	Click <b>Enable</b> box to activate this rule.
<b>Save</b>	NA	Click the <b>Save</b> button to save the configuration
<b>Undo</b>	NA	Click the <b>Undo</b> button to restore what you just configured back to the previous setting.
<b>Back</b>	NA	When the <b>Back</b> button is clicked the screen will return to the Static Routing Configuration page.

# 4G IIoT Gateway

## 2.5.2 Dynamic Routing

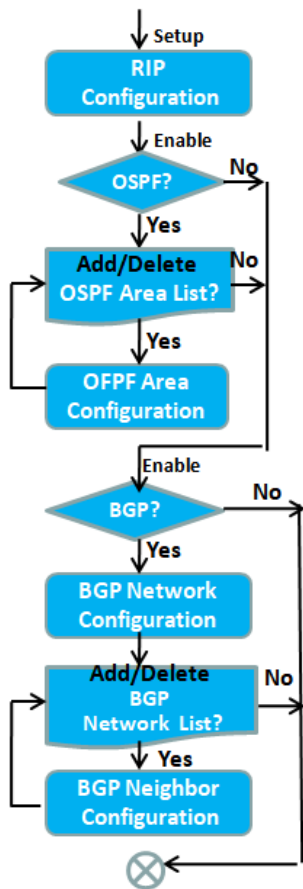

RIP Configuration [ Help ]				
Item	Setting			
▶ RIP Enable	<input type="text" value="Disable"/>			

OSPF Configuration				
Item	Setting			
▶ OSPF	<input type="checkbox"/> Enable			
▶ OSPF Area List <input type="button" value="Add"/> <input type="button" value="Delete"/>				
ID	Area Subnet	Area ID	Enable	Actions

OSPF Area Configuration	
Item	Setting
▶ Area Subnet	<input type="text"/>

BGP Configuration	
Item	Setting
▶ BGP	<input type="checkbox"/> Enable

BGP Network Configuration			
Item	Setting		
▶ Network Subnet	IP : <input type="text"/> <input type="text" value="255.255.255.0 (/24)"/>		
▶ BGP Network List <input type="button" value="Add"/> <input type="button" value="Delete"/>			
ID	Network Subnet	Enable	Actions

BGP Neighbor Configuration	
Item	Setting
▶ Neighbor IP	<input type="text"/>

Dynamic Routing, also called adaptive routing, describes the capability of a system, through which routes are characterized by their destination, to alter the path that the route takes through the system in response to a change in network conditions.

This gateway supports dynamic routing protocols, including RIPv1/RIPv2 (Routing Information Protocol), OSPF (Open Shortest Path First), and BGP (Border Gateway Protocol), for you to establish routing table automatically. The feature of dynamic routing will be very useful when there are lots of subnets in your network. Generally speaking, RIP is suitable for small network. OSPF is more suitable for medium network. BGP is more used for big network infrastructure.

The supported dynamic routing protocols are described as follows.

# 4G IIoT Gateway

## RIP Scenario

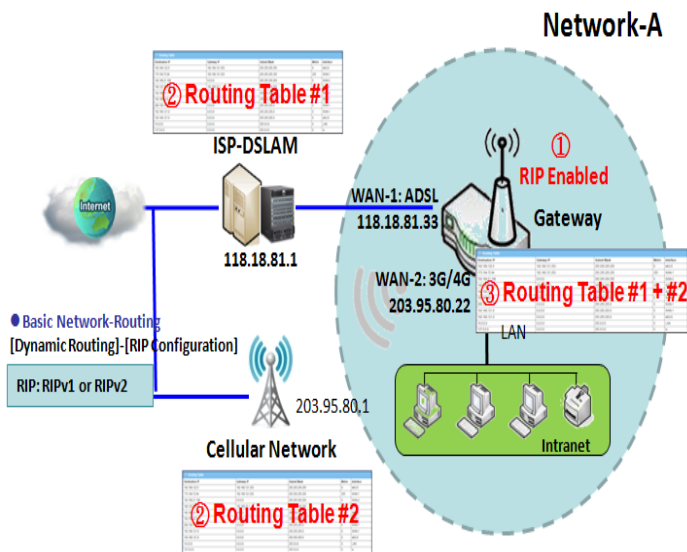

The Routing Information Protocol (RIP) is one of the oldest distance-vector routing protocols, which employs the hop count as a routing metric. RIP prevents routing loops by implementing a limit on the number of hops allowed in a path from the source to a destination. The maximum number of hops allowed for RIP is 15. This hop limit, however, also limits the size of networks that RIP can support. A hop count of 16 is considered an infinite distance, in other words the route is considered unreachable. RIP implements the split horizon, route poisoning and hold-down mechanisms to prevent incorrect routing information from being propagated.

## OSPF Scenario

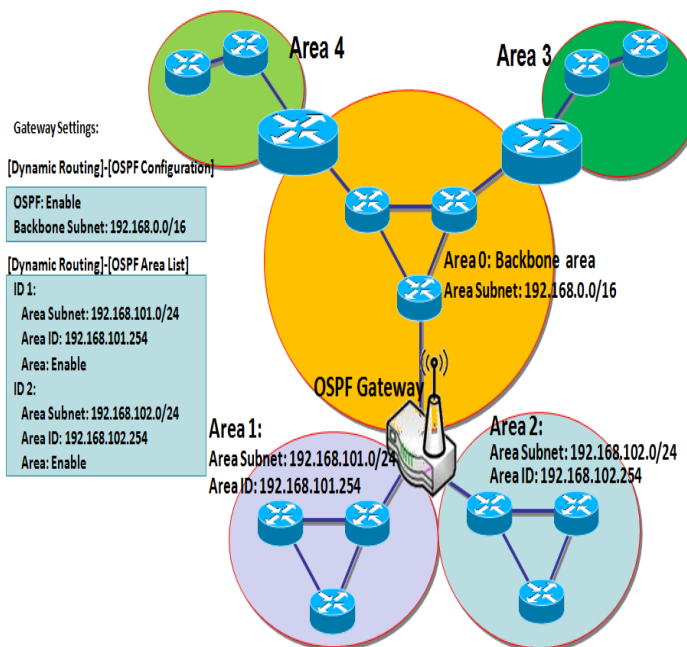

Open Shortest Path First (OSPF) is a routing protocol that uses link state routing algorithm. It is the most widely used interior gateway protocol (IGP) in large enterprise networks. It gathers link state information from available routers and constructs a topology map of the network. The topology is presented as a routing table which routes datagrams based solely on the destination IP address.

Network administrator can deploy OSPF gateway in large enterprise network to get its routing table from the enterprise backbone, and forward routing information to other routers, which are no linked to the enterprise backbone. Usually, an OSPF network is subdivided into routing areas to simplify administration and optimize traffic and resource utilization.

As shown in the diagram, OSPF gateway gathers routing information from the backbone gateways in area 0, and will forward its routing information to the routers in area 1 and area 2 which are not in the backbone.

# 4G IIoT Gateway

## BGP Scenario

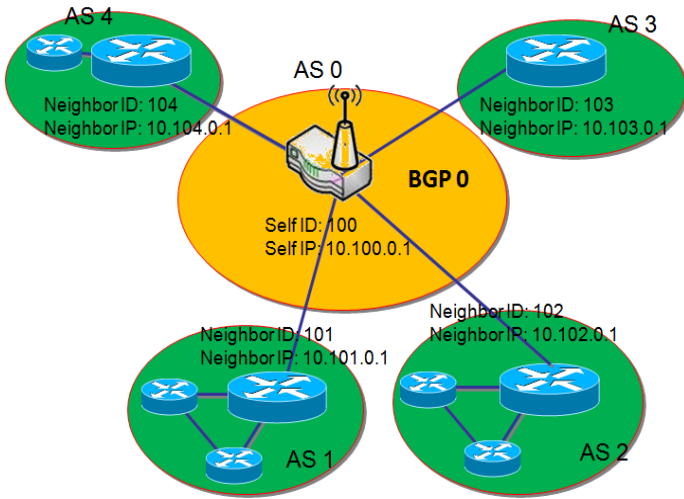

Border Gateway Protocol (BGP) is a standard exterior gateway protocol designed to exchange routing and reachability information between autonomous systems (AS) on the Internet. It usually makes routing decisions based on paths, network policies, or rule-sets.

Most ISPs use BGP to establish routing between one another (especially for multi-homed). Very large private IP networks also use BGP internally. The major BGP gateway within one AS will link with some other border gateways for exchanging routing information. It will distribute the collected data in AS to all routers in other AS.

As shown in the diagram, BGP 0 is gateway to dominate AS 0 (self IP is 10.100.0.1 and self ID is 100). It links with other BGP gateways in the Internet. The scenario is like Subnet in one ISP to be linked with the ones in other ISPs. By operating with BGP protocol, BGP 0 can gather routing information from other BGP gateways in the Internet. And then it forwards the routing data to the routers in its dominated AS. Finally, the routers resided in AS 0 know how to route packets to other AS.

# 4G IIoT Gateway

## Dynamic Routing Setting

Go to **Basic Network > Routing > Dynamic Routing** Tab.

The dynamic routing setting allows user to customize RIP, OSPF, and BGP protocol through the router based on their office setting.

In the "Dynamic Routing" page, there are several configuration windows for dynamic routing feature. They are the "RIP Configuration" window, "OSPF Configuration" window, "OSPF Area List", "OSPF Area Configuration", "BGP Configuration", "BGP Neighbor List" and "BGP Neighbor Configuration" window. RIP, OSPF and BGP protocols can be configured individually.

The "RIP Configuration" window lets you choose which version of RIP protocol to be activated or disable it. The "OSPF Configuration" window can let you activate the OSPF dynamic routing protocol and specify its backbone subnet. Moreover, the "OSPF Area List" window lists all defined areas in the OSPF network. However, the "BGP Configuration" window can let you activate the BGP dynamic routing protocol and specify its self ID. The "BGP Neighbor List" window lists all defined neighbors in the BGP network.

### RIP Configuration

The RIP configuration setting allows user to customize RIP protocol through the router based on their office setting.

RIP Configuration <span style="float: right;">[ Help ]</span>	
Item	Setting
▶ RIP Enable	Disable ▼

RIP Configuration		
Item	Value setting	Description
<b>RIP Enable</b>	Disable is set by default	Select <b>Disable</b> will disable RIP protocol. Select <b>RIP v1</b> will enable RIPv1 protocol. Select <b>RIP v2</b> will enable RIPv2 protocol.

### OSPF Configuration

The OSPF configuration setting allows user to customize OSPF protocol through the router based on their office setting.

# 4G IIoT Gateway

OSPF Configuration	
Item	Setting
▶ OSPF	<input type="checkbox"/> Enable
▶ Router ID	<input type="text"/>
▶ Authentication	None ▾
▶ Backbone Subnet	<input type="text"/>

OSPF Configuration		
Item	Value setting	Description
<b>OSPF</b>	Disable is set by default	Click <b>Enable</b> box to activate the OSPF protocol.
<b>Router ID</b>	1. IPv4 Format 2. A Must filled setting	The Router ID of this router on OSPF protocol
<b>Authentication</b>	None is set by default	The Authentication method of this router on OSPF protocol. Select <b>None</b> will disable Authentication on OSPF protocol. Select <b>Text</b> will enable Text Authentication with entered the Key in this field on OSPF protocol. Select <b>MD5</b> will enable MD5 Authentication with entered the ID and Key in these fields on OSPF protocol.
<b>Backbone Subnet</b>	1. Classless Inter Domain Routing (CIDR) Subnet Mask Notation. (Ex: 192.168.1.0/24) 2. A Must filled setting	The Backbone Subnet of this router on OSPF protocol.

## Create / Edit OSPF Area Rules

The gateway allows you to custom your OSPF Area List rules. It supports up to a maximum of 32 rule sets.

OSPF Area List <input type="button" value="Add"/> <input type="button" value="Delete"/>				
ID	Area Subnet	Area ID	Enable	Actions

When **Add** button is applied, **OSPF Area Rule Configuration** screen will appear.

# 4G IIoT Gateway

OSPF Area Configuration	
Item	Setting
▶ Area Subnet	<input type="text"/>
▶ Area ID	<input type="text"/>
▶ Area	<input type="checkbox"/> Enable
<input type="button" value="Save"/>	

OSPF Area Configuration		
Item	Value setting	Description
<b>Area Subnet</b>	1. Classless Inter Domain Routing (CIDR) Subnet Mask Notation. (Ex: 192.168.1.0/24) 2. A Must filled setting	The Area Subnet of this router on OSPF Area List.
<b>Area ID</b>	1. IPv4 Format 2. A Must filled setting	The Area ID of this router on OSPF Area List.
<b>Area</b>	The box is unchecked by default.	Click <b>Enable</b> box to activate this rule.
<b>Save</b>	N/A	Click the <b>Save</b> button to save the configuration

# 4G IIoT Gateway

## BGP Configuration

The BGP configuration setting allows user to customize BGP protocol through the router setting.

BGP Configuration	
Item	Setting
▶ BGP	<input type="checkbox"/> Enable
▶ ASN	<input type="text"/>
▶ Router ID	<input type="text"/>

Item	Value setting	Description
BGP	The box is unchecked by default	Check the <b>Enable</b> box to activate the BGP protocol.
ASN	1. Numeric String Format 2. A Must filled setting	The ASN Number of this router on BGP protocol. <b>Value Range: 1 ~ 4294967295.</b>
Router ID	1. IPv4 Format 2. A Must filled setting	The Router ID of this router on BGP protocol.

## Create / Edit BGP Network Rules

The gateway allows you to custom your BGP Network rules. It supports up to a maximum of 32 rule sets.

BGP Network List <input type="button" value="Add"/> <input type="button" value="Delete"/>			
ID	Network Subnet	Enable	Actions

When **Add** button is applied, **BGP Network Configuration** screen will appear.

BGP Network Configuration	
Item	Setting
▶ Network Subnet	IP : <input type="text"/> <input type="text" value="255.255.255.0 (/24)"/> ▼
▶ Network	<input type="checkbox"/> Enable
<input type="button" value="Save"/>	

Item	Value setting	Description
<b>Network Subnet</b>	1. IPv4 Format	The Network Subnet of this router on BGP Network List. It composes of entered

# 4G IIoT Gateway

	2. A Must filled setting	the IP address in this field and the selected subnet mask.
<b>Network</b>	The box is unchecked by default.	Click <b>Enable</b> box to activate this rule.
<b>Save</b>	N/A	Click the <b>Save</b> button to save the configuration

## Create / Edit BGP Neighbor Rules

The gateway allows you to custom your BGP Neighbor rules. It supports up to a maximum of 32 rule sets.

BGP Neighbor List <input type="button" value="Add"/> <input type="button" value="Delete"/>				
ID	Neighbor IP	Remote ASN	Enable	Actions

When **Add** button is applied, **BGP Neighbor Configuration** screen will appear.

BGP Neighbor Configuration	
Item	Setting
▶ Neighbor IP	<input type="text"/>
▶ Remote ASN	<input type="text"/>
▶ Neighbor	<input type="checkbox"/> Enable
<input type="button" value="Save"/>	

BGP Neighbor Configuration		
Item	Value setting	Description
<b>Neighbor IP</b>	1. IPv4 Format 2. A Must filled setting	The Neighbor IP of this router on BGP Neighbor List.
<b>Remote ASN</b>	1. Numeric String Format 2. A Must filled setting	The Remote ASN of this router on BGP Neighbor List. <b>Value Range: 1 ~ 4294967295.</b>
<b>Neighbor</b>	The box is unchecked by default.	Click <b>Enable</b> box to activate this rule.
<b>Save</b>	N/A	Click the <b>Save</b> button to save the configuration

# 4G IIoT Gateway

## 2.5.3 Routing Information

The routing information allows user to view the routing table and policy routing information. Policy Routing Information is only available when the Load Balance function is enabled and the Load Balance Strategy is By User Policy.

Go to **Basic Network > Routing > Routing Information** Tab.

Routing Table				
Destination IP	Subnet Mask	Gateway IP	Metric	Interface
192.168.1.0	255.255.255.0	0.0.0.0	0	LAN
169.254.0.0	255.255.0.0	0.0.0.0	0	LAN
239.0.0.0	255.0.0.0	0.0.0.0	0	LAN
127.0.0.0	255.0.0.0	0.0.0.0	0	lo

Routing Table		
Item	Value setting	Description
Destination IP	N/A	Routing record of Destination IP. IPv4 Format.
Subnet Mask	N/A	Routing record of Subnet Mask. IPv4 Format.
Gateway IP	N/A	Routing record of Gateway IP. IPv4 Format.
Metric	N/A	Routing record of Metric. Numeric String Format.
Interface	N/A	Routing record of Interface Type. String Format.

Policy Routing Information				
Policy Routing Source	Source IP	Destination IP	Destination Port	WAN Interface
Load Balance	-	-	-	-

Policy Routing Information		
Item	Value setting	Description
Policy Routing Source	N/A	Policy Routing of Source. String Format.
Source IP	N/A	Policy Routing of Source IP. IPv4 Format.
Destination IP	N/A	Policy Routing of Destination IP. IPv4 Format.
Destination Port	N/A	Policy Routing of Destination Port. String Format.
WAN Interface	N/A	Policy Routing of WAN Interface. String Format.

# 4G IIoT Gateway

## 2.6 DNS & DDNS

How does user access your server if your WAN IP address changes all the time? One way is to register a new domain name, and maintain your own DNS server. Another simpler way is to apply a domain name to a third-party DDNS service provider. The service can be free or charged. If you want to understand the basic concepts of DNS and Dynamic DNS, you can refer to Wikipedia website<sup>3,4</sup>.

### 2.6.1 DNS & DDNS Configuration

#### Dynamic DNS

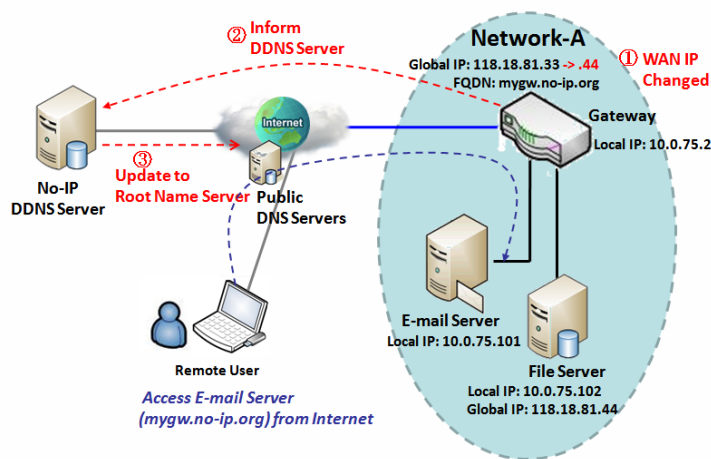

To host your server on a changing IP address, you have to use dynamic domain name service (DDNS). Therefore, anyone wishing to reach your host only needs to know the domain name. Dynamic DNS will map the name of your host to your current IP address, which changes each time you connect your Internet service provider.

The Dynamic DNS service allows the gateway to alias a public dynamic IP address to a static domain name, allowing the gateway to be more easily accessed from various locations on the Internet. As shown in the diagram, user registered a domain

name to a third-party DDNS service provider (NO-IP) to use DDNS function. Once the IP address of designated WAN interface has changed, the dynamic DNS agent in the gateway will inform the DDNS server with the new IP address. The server automatically re-maps your domain name with the changed IP address. So, other hosts or remote users in the Internet world are able to link to your gateway by using your domain name regardless of the changing global IP address.

3 [http://en.wikipedia.org/wiki/Domain\\_Name\\_System](http://en.wikipedia.org/wiki/Domain_Name_System)

4 [http://en.wikipedia.org/wiki/Dynamic\\_DNS](http://en.wikipedia.org/wiki/Dynamic_DNS)

# 4G IIoT Gateway

## DNS & DDNS Setting

Go to **Basic Network > DNS & DDNS > Configuration** Tab.

The DNS & DDNS setting allows user to setup Dynamic DNS feature and DNS redirect rules.

### Setup Dynamic DNS

The gateway allows you to custom your Dynamic DNS settings.

Dynamic DNS [ Help ]	
Item	Setting
▶ DDNS	<input type="checkbox"/> Enable
▶ WAN Interface	WAN-1 ▼
▶ Provider	DynDNS.org(Dynamic) ▼
▶ Host Name	<input type="text"/>
▶ User Name / E-Mail	<input type="text"/>
▶ Password / Key	<input type="text"/>

DDNS (Dynamic DNS) Configuration		
Item	Value setting	Description
<b>DDNS</b>	The box is unchecked by default	Check the <b>Enable</b> box to activate this function.
<b>WAN Interface</b>	WAN 1 is set by default	Select the WAN Interface IP Address of the gateway.
<b>Provider</b>	<b>DynDNS.org (Dynamic)</b> is set by default	Select your DDNS provider of Dynamic DNS. It can be <b>DynDNS.org(Dynamic)</b> , <b>DynDNS.org(Custom)</b> , <b>NO-IP.com</b> , etc...
<b>Host Name</b>	1. String format can be any text 2. A Must filled setting	Your registered host name of Dynamic DNS. <b>Value Range: 0 ~ 63 characters.</b>
<b>User Name / E-Mail</b>	1. String format can be any text 2. A Must filled setting	Enter your User name or E-mail addresss of Dynamic DNS.
<b>Password / Key</b>	1. String format can be any text 2. A Must filled setting	Enter your Password or Key of Dynamic DNS.
<b>Save</b>	N/A	Click <b>Save</b> to save the settings
<b>Undo</b>	N/A	Click <b>Undo</b> to cancel the settings

# 4G IIoT Gateway

## Setup DNS Redirect

DNS redirect is a special function to redirect certain traffics to a specified host. Administator can manage the internet / intranet traffics that are going to access some restricted DNS and force those traffics to be redirected to a specified host.

DNS Redirect	
Item	Setting
▶ DNS Redirect	<input type="checkbox"/> Enable

DNS Redirect Configuration		
Item	Value setting	Description
<b>DNS Redirect</b>	The box is unchecked by default	Check the <b>Enable</b> box to activate this function.
<b>Save</b>	N/A	Click <b>Save</b> to save the settings
<b>Undo</b>	N/A	Click <b>Undo</b> to cancel the settings

If you enabled the DNS Redirect function, you have to further specify the redirect rules. According to the rules, the gateway can redirect the traffic that matched the DNS to corresponding pre-defined IP address.

Redirect Rule <input type="button" value="Add"/> <input type="button" value="Delete"/>					
ID	Mapping Rule	Condition	Description	Enable	Action

When **Add** button is applied, **Redirect Rule** screen will appear.

Redirect Rule <input type="button" value="Save"/> <input type="button" value="Back"/>					
Item	Setting				
Mapping Rule	<table border="1"><thead><tr><th>Domain Name</th><th>IP</th></tr></thead><tbody><tr><td><input type="text"/> (* for Any)</td><td><input type="text"/></td></tr></tbody></table>	Domain Name	IP	<input type="text"/> (* for Any)	<input type="text"/>
	Domain Name	IP			
<input type="text"/> (* for Any)	<input type="text"/>				
Condition	<input type="text" value="Always"/> ▼				
Description	<input type="text"/>				
Enable	<input type="checkbox"/> Enable				

Redirect Rule Configuration		
Item	Value setting	Description
<b>Domain Name</b>	1. String format can be any text	Enter a domain name to be redirect. The traffic to specified domain name will be redirect to the following IP address.

# 4G IIoT Gateway

	2. A Must filled setting	<b><i>Value Range:</i></b> at least 1 character is required; '*' for any.
<b>IP</b>	1. IPv4 format 2. A Must filled setting	Enter an IP Address as the target for the DNS redirect.
<b>Condition</b>	1. A Must filled setting <b>2. Always is selected by default.</b>	Specify when will the DNS redirect action can be applied. It can be <b>Always</b> , or <b>WAN Block</b> . <b>Always:</b> The DNS redirect function can be applied to matched DNS all the time. <b>WAN Block:</b> The DNS redirect function can be applied to matched DNS only when the WAN connection is disconnected, or un-reachable.
<b>Description</b>	1. String format can be any text 2. A Must filled setting	Enter a brief description for this rule. <b><i>Value Range:</i></b> 0 ~ 63 characters.
<b>Enable</b>	The box is unchecked by default	Click the <b>Enable</b> button to activate this rule.
<b>Save</b>	N/A	Click <b>Save</b> to save the settings
<b>Undo</b>	N/A	Click <b>Undo</b> to cancel the settings

## Chapter 3 Object Definition

### 3.1 Scheduling

Scheduling provides ability of adding/deleting time schedule rules, which can be applied to other functionality.

#### 3.1.1 Scheduling Configuration

Go to **Object Definition > Scheduling > Configuration** tab.

Time Schedule List <input type="button" value="Add"/> <input type="button" value="Delete"/>		
ID	Rule Name	Actions

Button description		
Item	Value setting	Description
<b>Add</b>	N/A	Click the <b>Add</b> button to configure time schedule rule
<b>Delete</b>	N/A	Click the <b>Delete</b> button to delete selected rule(s)

When **Add** button is applied, Time Schedule Configuration and Time Period Definition screens will appear.

Time Schedule Configuration	
Item	Setting
▶ Rule Name	<input type="text"/>
▶ Rule Policy	<input type="button" value="Inactivate"/> the Selected Days and Hours Below.

Time Schedule Configuration		
Item	Value Setting	Description
<b>Rule Name</b>	String: any text	Set rule name
<b>Rule Policy</b>	Default Inactivate	Inactivate/activate the function been applied to in the time period below

# 4G IIoT Gateway

Time Period Definition			
ID	Week Day	Start Time (hh:mm)	End Time (hh:mm)
1	-- choose one -- ▼	<input type="text"/>	<input type="text"/>
2	-- choose one -- ▼	<input type="text"/>	<input type="text"/>
3	-- choose one -- ▼	<input type="text"/>	<input type="text"/>
4	-- choose one -- ▼	<input type="text"/>	<input type="text"/>
5	-- choose one -- ▼	<input type="text"/>	<input type="text"/>
6	-- choose one -- ▼	<input type="text"/>	<input type="text"/>
7	-- choose one -- ▼	<input type="text"/>	<input type="text"/>
8	-- choose one -- ▼	<input type="text"/>	<input type="text"/>

Time Period Definition		
Item	Value Setting	Description
<b>Week Day</b>	Select from menu	Select everyday or one of weekday
<b>Start Time</b>	Time format (hh :mm)	Start time in selected weekday
<b>End Time</b>	Time format (hh :mm)	End time in selected weekday
<b>Save</b>	N/A	Click <b>Save</b> to save the settings
<b>Undo</b>	N/A	Click <b>Undo</b> to cancel the settings
<b>Refresh</b>	N/A	Click the <b>Refresh</b> button to refresh the time schedule list.

# 4G IIoT Gateway

## 3.2 Grouping

The Grouping function allows user to make group for some services.

### 3.2.1 Host Grouping

Go to **Object Definition > Grouping > Host Grouping** tab.

The Host Grouping function allows user to make host group for some services, such as QoS, Firewall, and Communication Bus. The supported service types could be different for the purchased product.

Host Group List <input type="button" value="Add"/> <input type="button" value="Delete"/>						
ID	Group Name	Group Type	Member List	Bound Services	Enable	Actions

When **Add** button is applied, **Host Group Configuration** screen will appear.

Host Group Configuration	
Item	Setting
▶ Group Name	<input type="text"/>
▶ Group Type	IP Address-based ▼
▶ Member to Join	<input type="text"/> <input type="button" value="Join"/>
▶ Member List	
▶ Bound Services	<input type="checkbox"/> Firewall <input type="checkbox"/> QoS <input type="checkbox"/> Field Communication
▶ Group	<input type="checkbox"/> Enable

Host Group Configuration		
Item	Value setting	Description
<b>Group Name</b>	1. String format can be any text 2. A Must filled setting	Enter a group name for the rule. It is a name that is easy for you to understand.
<b>Group Type</b>	1. <b>IP Address-based</b> is selected by default. 2. A Must filled setting	Select the group type for the host group. It can be <b>IP Address-based</b> , <b>MAC Address-based</b> , or <b>Host Name-based</b> . When <b>IP Address-based</b> is selected, only IP address can be added in <b>Member to Join</b> .

## 4G IIoT Gateway

		<p>When <b>MAC Address-based</b> is selected, only MAC address can be added in <b>Member to Join</b>.</p> <p>When <b>Host Name-based</b> is selected, only host name can be added in <b>Member to Join</b>.</p> <p>Note: The available Group Type can be different for the purchased model.</p>
<b>Member to Join</b>	N/A	<p>Add the members to the group in this field.</p> <p>You can enter the member information as specified in the Member Type above, and press the <b>Join</b> button to add.</p> <p>Only one member can be add at a time, so you have to add the members to the group one by one.</p>
<b>Member List</b>	NA	<p>This field will indicate the hosts (members) contained in the group.</p>
<b>Bound Services</b>	The boxes are unchecked by default	<p>Binding the services that the host group can be applied. If you enable the <b>Firewall</b>, the produced group can be used in firewall service. Same as by enable <b>QoS</b> and <b>Communication Bus</b>.</p> <p><b>Note:</b> The supported service type can be different for the purchased product.</p>
<b>Group</b>	The box is unchecked by default	<p>Check the <b>Enable</b> checkbox to activate the host group rule. So that the group can be bound to selected service(s) for further configuration.</p>
<b>Save</b>	N/A	<p>Click <b>Save</b> to save the settings</p>
<b>Undo</b>	N/A	<p>Click <b>Undo</b> to cancel the settings</p>

# 4G IIoT Gateway

## 3.3 External Server

Go to **Object Definition > External Server > External Server** tab.

The External Server setting allows user to add external server.

### Create External Server

External Server List <input type="button" value="Add"/> <input type="button" value="Delete"/>						
ID	Server Name	Server Type	Server IP/FQDN	Server Port	Server Enable	Actions

When **Add** button is applied, **External Server Configuration** screen will appear.

External Server Configuration	
Item	Setting
▶ Server Name	<input type="text"/>
▶ Server Type	<input type="text" value="Email Server"/> User Name: <input type="text"/> Password: <input type="text"/>
▶ Server IP/FQDN	<input type="text"/>
▶ Server Port	<input type="text" value="25"/>
▶ Server	<input checked="" type="checkbox"/> Enable
<input type="button" value="Save"/> <input type="button" value="Undo"/>	

# 4G IIoT Gateway

## External Server Configuration

Item	Value setting	Description
<b>Sever Name</b>	1. String format can be any text 2. A Must filled setting	Enter a server name. Enter a name that is easy for you to understand.
<b>Server Type</b>	A Must filled setting	<p>Specify the Server Type of the external server, and enter the required settings for the accessing the server.</p> <hr/> <p><b>Email Server</b> (A Must filled setting) :            When <b>Email Server</b> is selected, <b>User Name</b>, and <b>Password</b> are also required.  <b>User Name</b> (String format: any text)  <b>Password</b> (String format: any text)</p> <hr/> <p><b>RADIUS Server</b> (A Must filled setting) :            When <b>RADIUS Server</b> is selected, the following settings are also required.            Primary :  <b>Shared Key</b> (String format: any text)            Authentication Protocol (By default CHAP is selected)            Session Timeout (By default 1)            The values must be between 1 and 60.            Idle Timeout: (By default 1)            The values must be between 1 and 15.            Secondary :  <b>Shared Key</b> (String format: any text)            Authentication Protocol (By default CHAP is selected)            Session Timeout (By default 1)            The values must be between 1 and 60.            Idle Timeout: (By default 1)            The values must be between 1 and 15.</p> <hr/> <p><b>Active Directory Server</b> (A Must filled setting) :            When <b>Active Directory Server</b> is selected, <b>Domain</b> setting is also required.  <b>Domain</b> (String format: any text)</p> <hr/> <p><b>LDAP Server</b> (A Must filled setting) :            When <b>LDAP Server</b> is selected, the following settings are also required.  <b>Base DN</b> (String format: any text)  <b>Identity</b> (String format: any text)  <b>Password</b> (String format: any text)</p> <hr/> <p><b>UAM Server</b> (A Must filled setting) :            When <b>UAM Server</b> is selected, the following settings are also required.  <b>Login URL</b> (String format: any text)  <b>Shared Secret</b> (String format: any text)  <b>NAS/Gateway ID</b> (String format: any text)  <b>Location ID</b> (String format: any text)  <b>Location Name</b> (String format: any text)</p>

# 4G IIoT Gateway

		<p><b>TACACS+ Server</b> (A Must filled setting) :</p> <p>When <b>TACACS+ Server</b> is selected, the following settings are also required.</p> <p><b>Shared Key</b> (String format: any text)</p> <p><b>Session Timeout</b> (String format: any number)</p> <p>The values must be between 1 and 60.</p> <hr/> <p><b>SCEP Server</b> (A Must filled setting) :</p> <p>When <b>SCEP Server</b> is selected, the following settings are also required.</p> <p><b>Path</b> (String format: any text, By default <b>cgi-bin</b> is filled)</p> <p><b>Application</b> (String format: any text, By default <b>pkiclient.exe</b> is filled)</p> <hr/> <p><b>FTP(SFTP) Server</b> (A Must filled setting) :</p> <p>When <b>FTP(SFTP) Server</b> is selected, the following settings are also required.</p> <p><b>User Name</b> (String format: any text)</p> <p><b>Password</b> (String format: any text)</p> <p><b>Protocol</b> (Select <b>FTP</b> or <b>SFTP</b>)</p> <p><b>Encryprion</b> (Select <b>Plain</b>, <b>Explicit FTPS</b> or <b>Implicit FTPS</b>)</p> <p><b>Transfer mode</b> (Select <b>Passive</b> or <b>Active</b>)</p>
<b>Server IP/FQDN</b>	A Must filled setting	Specify the IP address or FQDN used for the external server.
<b>Server Port</b>	A Must filled setting	<p>Specify the Port used for the external server. If you selected a certain server type, the default server port number will be set.</p> <p>For <b>Email Server</b> 25 will be set by default;</p> <p>For <b>Syslog Server</b>, port 514 will be set by default;</p> <p>For <b>RADIUS Server</b>, port 1812, 1823 will be set by default;</p> <p>For <b>Active Directory Server</b>, port 389 will be set by default;</p> <p>For <b>LDAP Server</b>, port 389 will be set by default;</p> <p>For <b>UAM Server</b>, port 3990, 4990 will be set by default;</p> <p>For <b>TACACS+ Server</b>, port 49 will be set by default;</p> <p>For <b>SCEP Server</b>, port 80 will be set by default;</p> <p>For <b>FTP(SFTP) Server</b>, port 21 will be set by default;</p> <p><b>Value Range:</b> 1 ~ 65535.</p>
<b>Account Port</b>	<p>1. A Must filled setting</p> <p>2. <b>1813 is set by default</b></p>	<p>Specify the accounting port used if you selected external RADIUS server.</p> <p><b>Value Range:</b> 1 ~ 65535.</p>
<b>Server</b>	The box is checked by default	Click <b>Enable to</b> activate this External Server.
<b>Save</b>	N/A	Click <b>Save</b> to save the settings
<b>Undo</b>	N/A	Click <b>Undo</b> to cancel the settings
<b>Refresh</b>	N/A	Click the <b>Refresh</b> button to refresh the external server list.

## 3.4 Certificate

In cryptography, a public key certificate (also known as a digital certificate or identity certificate) is an electronic document used to prove ownership of a public key. The certificate includes information about the key, information about its owner's identity, and the digital signature of an entity that has verified the certificate's contents are genuine. If the signature is valid, and the person examining the certificate trusts the signer, then they know they can use that key to communicate with its owner<sup>5</sup>.

In a typical public-key infrastructure (PKI) scheme, the signer is a certificate authority (CA), usually a company such as VeriSign which charges customers to issue certificates for them. In a web of trust scheme, the signer is either the key's owner (a self-signed certificate) or other users ("endorsements") whom the person examining the certificate might know and trust. The device also plays as a CA role.

Certificates are an important component of Transport Layer Security (TLS, sometimes called by its older name SSL), where they prevent an attacker from impersonating a secure website or other server. They are also used in other important applications, such as email encryption and code signing. Here, it can be used in IPSec tunneling for user authentication.

### 3.4.1 Configuration

The configuration setting allows user to create Root Certificate Authority (CA) certificate and configure to set enable of SCEP. Root CA is the top-most certificate of the tree, the private key of which is used to "sign" other certificates.

Go to Object Definition > Certificate > Configuration tab.

#### Create Root CA



ID	Name	Subject	Issuer	Vaild To	Action
----	------	---------	--------	----------	--------

When **Generate** button is applied, **Root CA Certificate Configuration** screen will appear. The required information to be filled for the root CA includes the name, key, subject name and validity.

<sup>5</sup> [http://en.wikipedia.org/wiki/Public\\_key\\_certificate](http://en.wikipedia.org/wiki/Public_key_certificate).

# 4G IIoT Gateway

Root CA Certificate Configuration	
Item	Setting
▶ Name	<input type="text"/>
▶ Key	Key Type : <input type="text" value="RSA"/> Key Length : <input type="text" value="512-bits"/> Digest Algorithm : <input type="text" value="MD5"/>
▶ Subject Name	Country(C) : <input type="text"/> State(ST) : <input type="text"/> Location(L) : <input type="text"/> Organization(O) : <input type="text"/> Organization Unit(OU) : <input type="text"/> Common Name(CN) : <input type="text"/> Email : <input type="text"/>
▶ Validity Period	<input type="text" value="20-years"/>

Root CA Certificate Configuration		
Item	Value setting	Description
<b>Name</b>	1. String format can be any text 2. A Must filled setting	Enter a Root CA Certificate name. It will be a certificate file name
<b>Key</b>	A Must filled setting	This field is to specify the key attribute of certificate. <b>Key Type</b> to set public-key cryptosystems. It only supports RSA now. <b>Key Length</b> to set s the size measured in bits of the key used in a cryptographic algorithm. <b>Digest Algorithm</b> to set identifier in the signature algorithm identifier of certificates
<b>Subject Name</b>	A Must filled setting	This field is to specify the information of certificate. <b>Country(C)</b> is the two-letter ISO code for the country where your organization is located. <b>State(ST)</b> is the state where your organization is located. <b>Location(L)</b> is the location where your organization is located. <b>Organization(O)</b> is the name of your organization. <b>Organization Unit(OU)</b> is the name of your organization unit. <b>Common Name(CN)</b> is the name of your organization. <b>Email</b> is the email of your organization. It has to be email address style.
<b>Validity Period</b>	A Must filled setting	This field is to specify the validity period of certificate.

# 4G IIoT Gateway

## Setup SCEP

SCEP Configuration	
Item	Setting
▶ SCEP	<input type="checkbox"/> Enable
▶ Automatically re-enroll aging certificates	<input type="checkbox"/> Enable

SCEP Configuration		
Item	Value setting	Description
<b>SCEP</b>	The box is unchecked by default	Check the <b>Enable</b> box to activate SCEP function.
<b>Automatically re-enroll aging certificates</b>	The box is unchecked by default	When <b>SCEP</b> is activated, check the <b>Enable</b> box to activate this function. It will be automatically check which certificate is aging. If certificate is aging, it will activate SCEP function to re-enroll automatically.
<b>Save</b>	N/A	Click <b>Save</b> to save the settings
<b>Undo</b>	N/A	Click <b>Undo</b> to cancel the settings

# 4G IIoT Gateway

## 3.4.2 My Certificate

My Certificate includes a Local Certificate List. Local Certificate List shows all generated certificates by the root CA for the gateway. And it also stores the generated Certificate Signing Requests (CSR) which will be signed by other external CAs. The signed certificates can be imported as the local ones of the gateway.

### Self-signed Certificate Usage Scenario

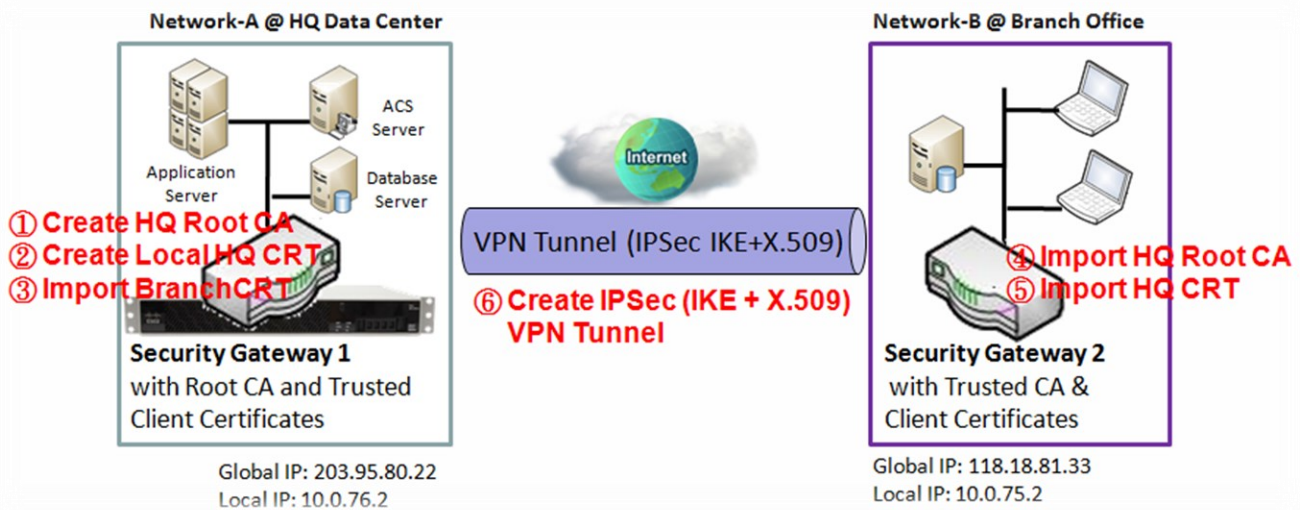

#### Scenario Application Timing

When the enterprise gateway owns the root CA and VPN tunneling function, it can generate its own local certificates by being signed by itself or import any local certificates that are signed by other external CAs. Also import the trusted certificates for other CAs and Clients. In addition, since it has the root CA, it also can sign Certificate Signing Requests (CSR) to form corresponding certificates for others. These certificates can be used for two remote peers to make sure their identity during establishing a VPN tunnel.

#### Scenario Description

Gateway 1 generates the root CA and a local certificate (HQCRT) signed by itself. Import a trusted certificate (BranchCRT) –a BranchCSR certificate of Gateway 2 signed by root CA of Gateway 1.

Gateway 2 creates a CSR (BranchCSR) to let the root CA of the Gateway 1 sign it to be the BranchCRT certificate. Import the certificate into the Gateway 2 as a local certificate. In addition, also import the certificates of the root CA of the Gateway 1 into the Gateway 2 as the trusted ones. (Please also refer to following two sub-sections)

Establish an IPsec VPN tunnel with IKE and X.509 protocols by starting from either peer, so that all

# 4G IIoT Gateway

client hosts in these both subnets can communicate with each other.

## Parameter Setup Example

For Network-A at HQ

Following tables list the parameter configuration as an example for the "My Certificate" function used in the user authentication of IPsec VPN tunnel establishing, as shown in above diagram. The configuration example must be combined with the ones in following two sections to complete the whole user scenario.

Use default value for those parameters that are not mentioned in the tables.

<b>Configuration Path</b>	[My Certificate]-[Root CA Certificate Configuration]
<b>Name</b>	<b>HQRootCA</b>
<b>Key</b>	Key Type: <b>RSA</b> Key Length: <b>1024-bits</b>
<b>Subject Name</b>	Country(C): <b>TW</b> State(ST): <b>Taiwan</b> Location(L): <b>Tainan</b> Organization(O): <b>HQ</b> Organization Unit(OU): <b>HQRD</b> Common Name(CN): <b>HQRootCA</b> E-mail: <b>hqrootca@dlink.com.tw</b>

<b>Configuration Path</b>	[My Certificate]-[Local Certificate Configuration]
<b>Name</b>	<b>HQCRT</b> Self-signed: <input checked="" type="checkbox"/>
<b>Key</b>	Key Type: <b>RSA</b> Key Length: <b>1024-bits</b>
<b>Subject Name</b>	Country(C): <b>TW</b> State(ST): <b>Taiwan</b> Location(L): <b>Tainan</b> Organization(O): <b>HQ</b> Organization Unit(OU): <b>HQRD</b> Common Name(CN): <b>HQCRT</b> E-mail: <b>hqcert@dlink.com.tw</b>

<b>Configuration Path</b>	[IPSec]-[Configuration]
<b>IPSec</b>	<input checked="" type="checkbox"/> <b>Enable</b>

<b>Configuration Path</b>	[IPSec]-[Tunnel Configuration]
<b>Tunnel</b>	<input checked="" type="checkbox"/> <b>Enable</b>
<b>Tunnel Name</b>	<b>s2s-101</b>
<b>Interface</b>	<b>WAN 1</b>
<b>Tunnel Scenario</b>	<b>Site to Site</b>
<b>Operation Mode</b>	<b>Always on</b>

<b>Configuration Path</b>	[IPSec]-[Local & Remote Configuration]
<b>Local Subnet</b>	<b>10.0.76.0</b>
<b>Local Netmask</b>	<b>255.255.255.0</b>
<b>Full Tunnel</b>	<b>Disable</b>
<b>Remote Subnet</b>	<b>10.0.75.0</b>
<b>Remote Netmask</b>	<b>255.255.255.0</b>
<b>Remote Gateway</b>	<b>118.18.81.33</b>

# 4G IIoT Gateway

<b>Configuration Path</b>	[IPSec]-[Authentication]
<b>Key Management</b>	<i>IKE+X.509</i> Local Certificate: <i>HQCRT</i> Remote Certificate: <i>BranchCRT</i>
<b>Local ID</b>	<i>User Name Network-A</i>
<b>Remote ID</b>	<i>User Name Network-B</i>

<b>Configuration Path</b>	[IPSec]-[IKE Phase]
<b>Negotiation Mode</b>	<i>Main Mode</i>
<b>X-Auth</b>	<i>None</i>

For Network-B at Branch Office

Following tables list the parameter configuration as an example for the "My Certificate" function used in the user authentication of IPSec VPN tunnel establishing, as shown in above diagram. The configuration example must be combined with the ones in following two sections to complete the whole user scenario.

Use default value for those parameters that are not mentioned in the tables.

<b>Configuration Path</b>	[My Certificate]-[Local Certificate Configuration]
<b>Name</b>	<i>BranchCRT</i> Self-signed: <input type="checkbox"/>
<b>Key</b>	Key Type: <i>RSA</i> Key Length: <i>1024-bits</i>
<b>Subject Name</b>	Country(C): <i>TW</i> State(ST): <i>Taiwan</i> Location(L): <i>Tainan</i> Organization(O): <i>Branch</i> Organization Unit(OU): <i>BranchRD</i> Common Name(CN): <i>BranchCRT</i> E-mail: <i>branchcrt@dlink.com.tw</i>

<b>Configuration Path</b>	[IPSec]-[Configuration]
<b>IPSec</b>	■ <i>Enable</i>

<b>Configuration Path</b>	[IPSec]-[Tunnel Configuration]
<b>Tunnel</b>	■ <i>Enable</i>
<b>Tunnel Name</b>	<i>s2s-102</i>
<b>Interface</b>	<i>WAN 1</i>
<b>Tunnel Scenario</b>	<i>Site to Site</i>
<b>Operation Mode</b>	<i>Always on</i>

<b>Configuration Path</b>	[IPSec]-[Local & Remote Configuration]
<b>Local Subnet</b>	<i>10.0.75.0</i>
<b>Local Netmask</b>	<i>255.255.255.0</i>
<b>Full Tunnel</b>	<i>Disable</i>
<b>Remote Subnet</b>	<i>10.0.76.0</i>

# 4G IloT Gateway

Remote Netmask	255.255.255.0
Remote Gateway	203.95.80.22

Configuration Path	[IPSec]-[Authentication]
Key Management	IKE+X.509 Local Certificate: <b>BranchCRT</b> Remote Certificate: <b>HQCRT</b>
Local ID	User Name Network-B
Remote ID	User Name Network-A

Configuration Path	[IPSec]-[IKE Phase]
Negotiation Mode	Main Mode
X-Auth	None

## Scenario Operation Procedure

In above diagram, "Gateway 1" is the gateway of Network-A in headquarters and the subnet of its Intranet is 10.0.76.0/24. It has the IP address of 10.0.76.2 for LAN interface and 203.95.80.22 for WAN-1 interface. "Gateway 2" is the gateway of Network-B in branch office and the subnet of its Intranet is 10.0.75.0/24. It has the IP address of 10.0.75.2 for LAN interface and 118.18.81.33 for WAN-1 interface. They both serve as the NAT security gateways.

Gateway 1 generates the root CA and a local certificate (HQCRT) that is signed by itself. Import the certificates of the root CA and HQCRT into the "Trusted CA Certificate List" and "Trusted Client Certificate List" of Gateway 2.

Gateway 2 generates a Certificate Signing Request (BranchCSR) for its own certificate (BranchCRT) (Please generate one not self-signed certificate in the Gateway 2, and click on the "View" button for that CSR. Just downloads it). Take the CSR to be signed by the root CA of Gateway 1 and obtain the BranchCRT certificate (you need rename it). Import the certificate into the "Trusted Client Certificate List" of the Gateway 1 and the "Local Certificate List" of Gateway 2.

Gateway 2 can establish an IPsec VPN tunnel with "Site to Site" scenario and IKE and X.509 protocols to Gateway 1.

Finally, the client hosts in two subnets of 10.0.75.0/24 and 10.0.76.0/24 can communicate with each other.

# 4G IIoT Gateway

## My Certificate Setting

Go to Object Definition > Certificate > My Certificate tab.

The My Certificate setting allows user to create local certificates. In "My Certificate" page, there are two configuration windows for the "My Certificate" function. The "Local Certificate List" window shows the stored certificates or CSRs for representing the gateway. The "Local Certificate Configuration" window can let you fill required information necessary for corresponding certificate to be generated by itself, or corresponding CSR to be signed by other CAs.

### Create Local Certificate

Local Certificate List					
ID	Name	Subject	Issuer	Vaild To	Actions

When **Add** button is applied, **Local Certificate Configuration** screen will appear. The required information to be filled for the certificate or CSR includes the name, key and subject name. It is a certificate if the "Self-signed" box is checked; otherwise, it is a CSR.

Local Certificate Configuration	
Item	Setting
▶ Name	<input type="text"/> Self-signed : <input type="checkbox"/>
▶ Key	Key Type : <input type="text" value="RSA"/> Key Length : <input type="text" value="1024-bits"/> Digest Algorithm : <input type="text" value="SHA-1"/>
▶ Subject Name	Country(C) : <input type="text"/> State(ST) : <input type="text"/> Location(L) : <input type="text"/> Organization(O) : <input type="text"/> Organization Unit(OU) : <input type="text"/> Common Name(CN) : <input type="text"/> Email : <input type="text"/>
▶ Extra Attributes	Challenge Password: <input type="text"/> Unstructured Name: <input type="text"/>
▶ SCEP Enrollment	Enable: <input type="checkbox"/> SCEP Server: <input type="text" value="-- Option --"/> <input type="button" value="Add Object"/> CA Certificate: <input type="text" value="-- Option --"/> CA Encryption Certificate: <input type="text" value="-- Option --"/> (Optional) CA Identifier: <input type="text"/> (Optional)

# 4G IIoT Gateway

Local Certificate Configuration		
Item	Value setting	Description
<b>Name</b>	1. String format can be any text 2. A Must filled setting	Enter a certificate name. It will be a certificate file name If <b>Self-signed</b> is checked, it will be signed by root CA. If <b>Self-signed</b> is not checked, it will generate a certificate signing request (CSR).
<b>Key</b>	A Must filled setting	This field is to specify the key attributes of certificate. <b>Key Type</b> to set public-key cryptosystems. Currently, only RSA is supported. <b>Key Length</b> to set the length in bits of the key used in a cryptographic algorithm. It can be 512/768/1024/1536/2048. <b>Digest Algorithm</b> to set identifier in the signature algorithm identifier of certificates. It can be MD5/SHA-1.
<b>Subject Name</b>	A Must filled setting	This field is to specify the information of certificate. <b>Country(C)</b> is the two-letter ISO code for the country where your organization is located. <b>State(ST)</b> is the state where your organization is located. <b>Location(L)</b> is the location where your organization is located. <b>Organization(O)</b> is the name of your organization. <b>Organization Unit(OU)</b> is the name of your organization unit. <b>Common Name(CN)</b> is the name of your organization. <b>Email</b> is the email of your organization. It has to be email address setting only.
<b>Extra Attributes</b>	A Must filled setting	This field is to specify the extra information for generating a certificate. <b>Challenge Password</b> for the password you can use to request certificate revocation in the future. <b>Unstructured Name</b> for additional information.
<b>SCEP Enrollment</b>	A Must filled setting	This field is to specify the information of SCEP. If user wants to generate a certificate signing request (CSR) and then signed by SCEP server online, user can check the <b>Enable</b> box. Select a <b>SCEP Server</b> to identify the SCEP server for use. The server detailed information could be specified in External Servers. Refer to <b>Object Definition &gt; External Server &gt; External Server</b> . You may click <b>Add Object</b> button to generate. Select a <b>CA Certificate</b> to identify which certificate could be accepted by SCEP server for authentication. It could be generated in Trusted Certificates. Select an optional <b>CA Encryption Certificate</b> , if it is required, to identify which certificate could be accepted by SCEP server for encryption data information. It could be generated in Trusted Certificates. Fill in optional <b>CA Identifier</b> to identify which CA could be used for signing certificates.
<b>Save</b>	N/A	Click the <b>Save</b> button to save the configuration.
<b>Back</b>	N/A	When the <b>Back</b> button is clicked, the screen will return to previous page.

When **Import** button is applied, an Import screen will appear. You can import a certificate from an existed certificate file, or directly paste a PEM encoded string as the certificate.

# 4G IIoT Gateway

The screenshot displays two tabs in a light blue header. The first tab, labeled 'Import', is active and contains a 'Choose File' button, the text 'No file chosen', and 'Apply' and 'Cancel' buttons. The second tab, labeled 'PEM Encoded', is inactive and contains a large empty text area with 'Apply' and 'Cancel' buttons at the bottom.

Import Item	Value setting	Description
<b>Import</b>	A Must filled setting	Select a certificate file from user's computer, and click the <b>Apply</b> button to import the specified certificate file to the gateway.
<b>PEM Encoded</b>	1. String format can be any text 2. A Must filled setting	This is an alternative approach to import a certificate. You can directly fill in (Copy and Paste) the PEM encoded certificate string, and click the <b>Apply</b> button to import the specified certificate to the gateway.
<b>Apply</b>	N/A	Click the <b>Apply</b> button to import the certificate.
<b>Cancel</b>	N/A	Click the <b>Cancel</b> button to discard the import operation and the screen will return to the My Certificates page.

# 4G IIoT Gateway

## 3.4.3 Trusted Certificate

Trusted Certificate includes Trusted CA Certificate List, Trusted Client Certificate List, and Trusted Client Key List. The Trusted CA Certificate List places the certificates of external trusted CAs. The Trusted Client Certificate List places the others' certificates what you trust. And the Trusted Client Key List places the others' keys what you trusted.

### Self-signed Certificate Usage Scenario

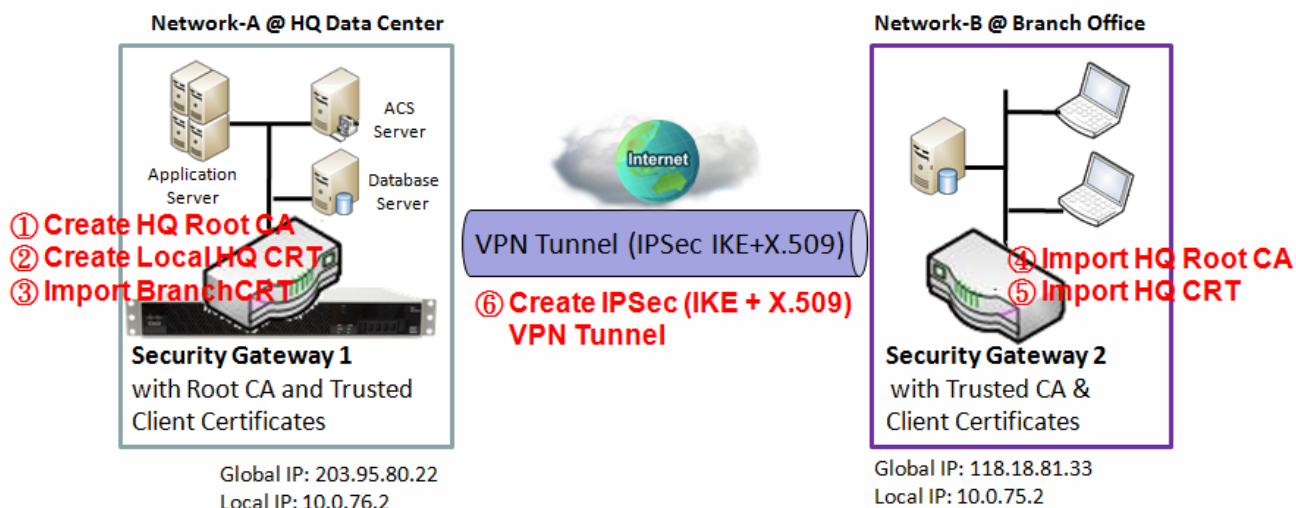

Scenario Application Timing (same as the one described in "My Certificate" section)

When the enterprise gateway owns the root CA and VPN tunneling function, it can generate its own local certificates by being signed by itself. Also imports the trusted certificates for other CAs and Clients. These certificates can be used for two remote peers to make sure their identity during establishing a VPN tunnel.

Scenario Description (same as the one described in "My Certificate" section)

Gateway 1 generates the root CA and a local certificate (HQCRT) signed by itself. Import a trusted certificate (BranchCRT) –a BranchCSR certificate of Gateway 2 signed by root CA of Gateway 1.

Gateway 2 creates a CSR (BranchCSR) to let the root CA of the Gateway 1 sign it to be the BranchCRT certificate. Import the certificate into the Gateway 2 as a local certificate. In addition, also imports the certificates of the root CA of Gateway 1 into the Gateway 2 as the trusted ones. (Please also refer to "My Certificate" and "Issue Certificate" sections).

Establish an IPSec VPN tunnel with IKE and X.509 protocols by starting from either peer, so that all client hosts in these both subnets can communicate with each other.

Parameter Setup Example (same as the one described in "My Certificate" section)

## 4G IIoT Gateway

For Network-A at HQ

Following tables list the parameter configuration as an example for the "Trusted Certificate" function used in the user authentication of IPsec VPN tunnel establishing, as shown in above diagram. The configuration example must be combined with the ones in "My Certificate" and "Issue Certificate" sections to complete the setup for the whole user scenario.

<b>Configuration Path</b>	[Trusted Certificate]-[Trusted Client Certificate List]
<b>Command Button</b>	<i>Import</i>

<b>Configuration Path</b>	[Trusted Certificate]-[Trusted Client Certificate Import from a File]
<b>File</b>	<i>BranchCRT.crt</i>

For Network-B at Branch Office

Following tables list the parameter configuration as an example for the "Trusted Certificate" function used in the user authentication of IPsec VPN tunnel establishing, as shown in above diagram. The configuration example must be combined with the ones in "My Certificate" and "Issued Certificate" sections to complete the setup for the whole user scenario.

<b>Configuration Path</b>	[Trusted Certificate]-[Trusted CA Certificate List]
<b>Command Button</b>	<i>Import</i>

<b>Configuration Path</b>	[Trusted Certificate]-[Trusted CA Certificate Import from a File]
<b>File</b>	<i>HQRootCA.crt</i>

<b>Configuration Path</b>	[Trusted Certificate]-[Trusted Client Certificate List]
<b>Command Button</b>	<i>Import</i>

<b>Configuration Path</b>	[Trusted Certificate]-[Trusted Client Certificate Import from a File]
<b>File</b>	<i>HQCRT.crt</i>

Scenario Operation Procedure (same as the one described in "My Certificate" section)

In above diagram, the "Gateway 1" is the gateway of Network-A in headquarters and the subnet of its Intranet is 10.0.76.0/24. It has the IP address of 10.0.76.2 for LAN interface and 203.95.80.22 for WAN-1 interface. The "Gateway 2" is the gateway of Network-B in branch office and the subnet of its Intranet is 10.0.75.0/24. It has the IP address of 10.0.75.2 for LAN interface and 118.18.81.33 for WAN-1 interface. They both serve as the NAT security gateways.

In Gateway 2 import the certificates of the root CA and HQCRT that were generated and signed by Gateway 1 into the "Trusted CA Certificate List" and "Trusted Client Certificate List" of Gateway 2.

## 4G IIoT Gateway

---

Import the obtained BranchCRT certificate (the derived BranchCSR certificate after Gateway 1's root CA signature) into the "Trusted Client Certificate List" of the Gateway 1 and the "Local Certificate List" of the Gateway 2. For more details, refer to the Network-B operation procedure in "My Certificate" section of this manual.

Gateway 2 can establish an IPsec VPN tunnel with "Site to Site" scenario and IKE and X.509 protocols to Gateway 1.

Finally, the client hosts in two subnets of 10.0.75.0/24 and 10.0.76.0/24 can communicate with each other.

# 4G IIoT Gateway

## Trusted Certificate Setting

Go to Object Definition > Certificate > Trusted Certificate tab.

The Trusted Certificate setting allows user to import trusted certificates and keys.

### Import Trusted CA Certificate

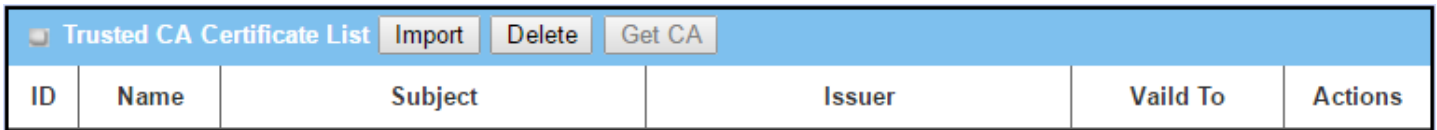

ID	Name	Subject	Issuer	Valid To	Actions
----	------	---------	--------	----------	---------

When **Import** button is applied, a **Trusted CA import** screen will appear. You can import a Trusted CA certificate from an existed certificate file, or directly paste a PEM encoded string as the certificate.

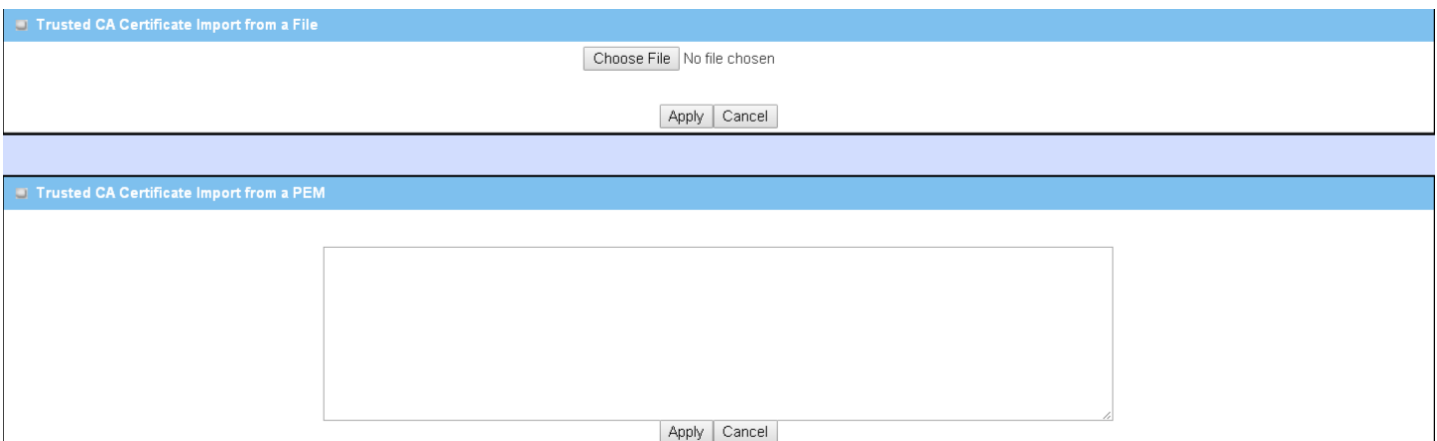

Item	Value setting	Description
<b>Import from a File</b>	A Must filled setting	Select a CA certificate file from user's computer, and click the <b>Apply</b> button to import the specified CA certificate file to the gateway.
<b>Import from a PEM</b>	1. String format can be any text 2. A Must filled setting	This is an alternative approach to import a CA certificate. You can directly fill in (Copy and Paste) the PEM encoded CA certificate string, and click the <b>Apply</b> button to import the specified CA certificate to the gateway.
<b>Apply</b>	N/A	Click the <b>Apply</b> button to import the certificate.
<b>Cancel</b>	N/A	Click the <b>Cancel</b> button to discard the import operation and the screen will return to the Trusted Certificates page.

Instead of importing a Trusted CA certificate with mentioned approaches, you can also get the CA certificate from the SECP server.

If **SCEP** is enabled (Refer to **Object Definition > Certificate > Configuration**), you can click **Get CA** button, a Get CA Configuration screen will appear.

# 4G IIoT Gateway

Get CA Configuration	
Item	Setting
▶ SCEP Server	<input type="text" value="--- Option ---"/> <input type="button" value="Add Object"/>
▶ CA Identifier	<input type="text"/> (Optional)

Get CA Configuration		
Item	Value setting	Description
SCEP Server	A Must filled setting	Select a <b>SCEP Server</b> to identify the SCEP server for use. The server detailed information could be specified in External Servers. Refer to <b>Object Definition &gt; External Server &gt; External Server</b> . You may click <b>Add Object</b> button to generate.
CA Identifier	1. String format can be any text	Fill in optional <b>CA Identifier</b> to identify which CA could be used for signing certificates.
Save	N/A	Click <b>Save</b> to save the settings.
Close	N/A	Click the <b>Close</b> button to return to the Trusted Certificates page.

## Import Trusted Client Certificate

Trusted Client Certificate List <input type="button" value="Import"/> <input type="button" value="Delete"/>					
ID	Name	Subject	Issuer	Vaild To	Actions

When **Import** button is applied, a **Trusted Client Certificate Import** screen will appear. You can import a Trusted Client Certificate from an existed certificate file, or directly paste a PEM encoded string as the certificate.

Trusted Client Certificate Import from a File	
<input type="button" value="Choose File"/> No file chosen	
<input type="button" value="Apply"/> <input type="button" value="Cancel"/>	

Trusted Client Certificate Import from a PEM	
<input type="text"/>	
<input type="button" value="Apply"/> <input type="button" value="Cancel"/>	

# 4G IIoT Gateway

Trusted Client Certificate List		
Item	Value setting	Description
<b>Import from a File</b>	A Must filled setting	Select a certificate file from user's computer, and click the <b>Apply</b> button to import the specified certificate file to the gateway.
<b>Import from a PEM</b>	1. String format can be any text 2. A Must filled setting	This is an alternative approach to import a certificate. You can directly fill in (Copy and Paste) the PEM encoded certificate string, and click the <b>Apply</b> button to import the specified certificate to the gateway.
<b>Apply</b>	N/A	Click the <b>Apply</b> button to import certificate.
<b>Cancel</b>	N/A	Click the <b>Cancel</b> button to discard the import operation and the screen will return to the Trusted Certificates page.

## Import Trusted Client Key

Trusted Client Key List <span>Import</span> <span>Delete</span>		
ID	Name	Actions

When **Import** button is applied, a **Trusted Client Key Import** screen will appear. You can import a Trusted Client Key from an existed file, or directly paste a PEM encoded string as the key.

**Trusted Client Key Import from a File**

Choose File No file chosen

Apply Cancel

**Trusted Client Key Import from a PEM**

Apply Cancel

Trusted Client Key List		
Item	Value setting	Description
<b>Import from a File</b>	A Must filled setting	Select a certificate key file from user's computer, and click the <b>Apply</b> button to import the specified key file to the gateway.
<b>Import from a PEM</b>	1. String format can be any text 2. A Must filled setting	This is an alternative approach to import a certificate key. You can directly fill in (Copy and Paste) the PEM encoded certificate key string, and click the <b>Apply</b> button to import the specified certificate key to the gateway.
<b>Apply</b>	N/A	Click the <b>Apply</b> button to import the certificate key.
<b>Cancel</b>	N/A	Click the <b>Cancel</b> button to discard the import operation and the screen will return to the Trusted Certificates page.

# 4G IIoT Gateway

## 3.4.4 Issue Certificate

When you have a Certificate Signing Request (CSR) that needs to be certificated by the root CA of the device, you can issue the request here and let Root CA sign it. There are two approaches to issue a certificate. One is from a CSR file importing from the managing PC and another is copy-paste the CSR codes in gateway's web-based utility, and then click on the "Sign" button.

If the gateway signs a CSR successfully, the "Signed Certificate View" window will show the resulted certificate contents. In addition, a "Download" button is available for you to download the certificate to a file in the managing PC.

### Self-signed Certificate Usage Scenario

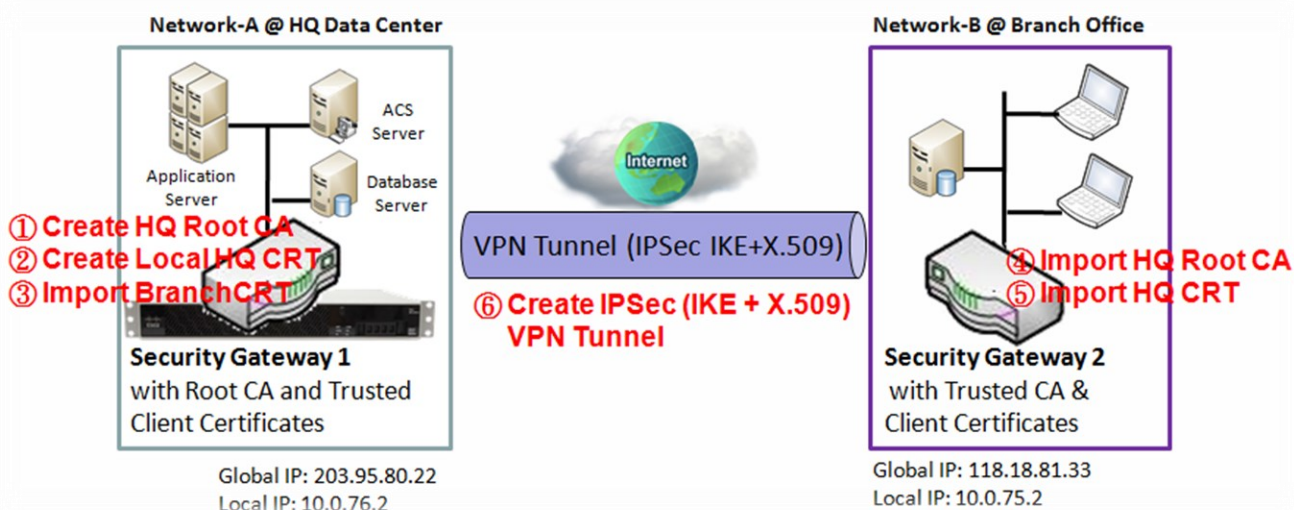

Scenario Application Timing (same as the one described in "My Certificate" section)

When the enterprise gateway owns the root CA and VPN tunneling function, it can generate its own local certificates by being signed by itself. Also imports the trusted certificates for other CAs and Clients. These certificates can be used for two remote peers to make sure their identity during establishing a VPN tunnel.

Scenario Description (same as the one described in "My Certificate" section)

Gateway 1 generates the root CA and a local certificate (HQCRT) signed by itself. Also imports a trusted certificate (BranchCRT) –a BranchCSR certificate of Gateway 2 signed by root CA of Gateway 1.

Gateway 2 creates a CSR (BranchCSR) to let the root CA of the Gateway 1 sign it to be the BranchCRT certificate. Import the certificate into the Gateway 2 as a local certificate. In addition,

## 4G IloT Gateway

also imports the certificates of the root CA of the Gateway 1 into the Gateway 2 as the trusted ones. (Please also refer to "My Certificate" and "Trusted Certificate" sections).

Establish an IPSec VPN tunnel with IKE and X.509 protocols by starting from either peer, so that all client hosts in these both subnets can communicate with each other.

Parameter Setup Example (same as the one described in "My Certificate" section)

For Network-A at HQ

Following tables list the parameter configuration as an example for the "Issue Certificate" function used in the user authentication of IPSec VPN tunnel establishing, as shown in above diagram. The configuration example must be combined with the ones in "My Certificate" and "Trusted Certificate" sections to complete the setup for whole user scenario.

<b>Configuration Path</b>	[Issue Certificate]-[Certificate Signing Request Import from a File]
<b>Browse</b>	<i>C:/BranchCSR</i>
<b>Command Button</b>	<i>Sign</i>

<b>Configuration Path</b>	[Issue Certificate]-[Signed Certificate View]
<b>Command Button</b>	<i>Download</i> (default name is "issued.crt")

Scenario Operation Procedure (same as the one described in "My Certificate" section)

In above diagram, the "Gateway 1" is the gateway of Network-A in headquarters and the subnet of its Intranet is 10.0.76.0/24. It has the IP address of 10.0.76.2 for LAN interface and 203.95.80.22 for WAN-1 interface. The "Gateway 2" is the gateway of Network-B in branch office and the subnet of its Intranet is 10.0.75.0/24. It has the IP address of 10.0.75.2 for LAN interface and 118.18.81.33 for WAN-1 interface. They both serve as the NAT security gateways.

Gateway 1 generates the root CA and a local certificate (HQCRT) that is signed by itself. Import the certificates of the root CA and HQCRT into the "Trusted CA Certificate List" and "Trusted Client Certificate List" of Gateway 2.

Gateway 2 generates a Certificate Signing Request (BranchCSR) for its own certificate BranchCRT to be signed by root CA (Please generate one not self-signed certificate in the Gateway 2, and click on the "View" button for that CSR. Just downloads it). Take the CSR to be signed by the root CA of the Gateway 1 and obtain the BranchCRT certificate (you need rename it). Import the certificate into the "Trusted Client Certificate List" of the Gateway 1 and the "Local Certificate List" of the Gateway 2.

Gateway 2 can establish an IPSec VPN tunnel with "Site to Site" scenario and IKE and X.509 protocols to Gateway 1.

Finally, the client hosts in two subnets of 10.0.75.0/24 and 10.0.76.0/24 can communicate with each other.

# 4G IIoT Gateway

## Issue Certificate Setting

Go to Object Definition > Certificate > Issue Certificate tab.

The Issue Certificate setting allows user to import Certificate Signing Request (CSR) to be signed by root CA.

### Import and Issue Certificate

The screenshot displays the 'Issue Certificate' configuration page. It is divided into two main sections. The top section, titled 'Certificate Signing Request (CSR) Import from a File', includes a 'Sign' button and a file selection area with a 'Choose File' button and the text 'No file chosen'. The bottom section, titled 'Certificate Signing Request (CSR) Import from a PEM', features a large, empty text area for pasting the certificate data, with a 'Sign' button positioned to its right.

Certificate Signing Request (CSR) Import from a File		
Item	Value setting	Description
<b>Certificate Signing Request (CSR) Import from a File</b>	A Must filled setting	Select a certificate signing request file you're your computer for importing to the gateway.
<b>Certificate Signing Request (CSR) Import from a PEM</b>	1. String format can be any text 2. A Must filled setting	Enter (copy-paste) the certificate signing request PEM encoded certificate to the gateway.
<b>Sign</b>	N/A	When root CA is exist, click the <b>Sign</b> button sign and issue the imported certificate by root CA.

## Chapter 4 Field Communication

### 4.1 Bus & Protocol

The gateway may equip a serial port for various serial communication use through connecting the RS-232 or RS-485 serial device to an IP-based Ethernet LAN. These communication protocols make user access serial devices anywhere over a local LAN or the Internet easily. They can be "Virtual COM" and "Modbus".

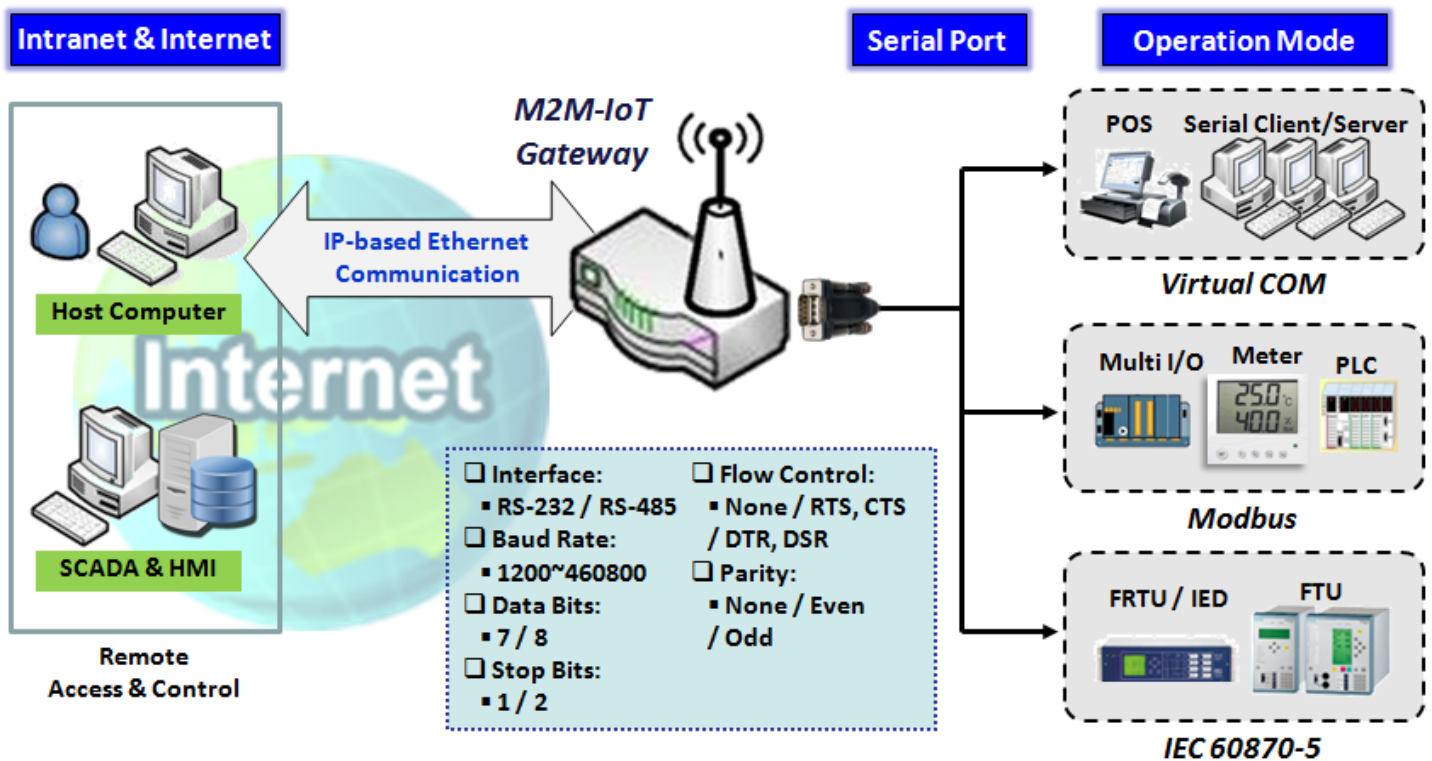

#### 4.1.1 Port Configuration

Before using the supported field communication function, like Virtual COM or Modbus, you need to configure the physical communication port first.

The port configuration screen allows user to configure the operation mode and physical layer settings for each serial interface, and also can quick switch from one communication protocol to another for the serial port. The number of ports and type of the supported protocols could be different for the purchased gateway model.

# 4G IIoT Gateway

## Port Configuration Setting

Go to **Field Communication > Bus & Protocol > Port Configuration** tab.

In "Port Configuration" page, there is only one configuration window for the serial port settings. The "Configuration" window can let you specify serial port parameters including the operation mode being "Virtual COM", "Modbus" or disabled, the interface being "RS-232" or "RS-485", the baud rate, the data bit length, the stop bit length, the flow control being "RTS/CTS", "DTS/DSR" or "None", and the parity.

Serial Port Definition								
Serial Port	Operation Mode	Interface	Baud Rate	Data Bits	Stop Bits	Flow Control	Parity	Action
SPort-0	Disable ▼	RS-232 ▼	9600 ▼	8 ▼	1 ▼	None ▼	None ▼	Edit

Port Configuration Window		
Item	Value setting	Description
<b>Serial Port</b>	N/A	It displays the serial port ID of the serial port. The number of serial ports varies from the purchased model.
<b>Operation Mode</b>	Disable is set by default	It displays the current selected operation mode for the serial interface. Depending on the purchase model, the available modes can be Virtual COM, Modbus, and IEC 60870-5.
<b>Interface</b>	RS-232 is set by default	Select RS-232 or RS-485 physical interface for connecting to the access device(s) with the same interface specification.
<b>Baud Rate</b>	19200 is set by default	Select the appropriate baud rate for serial device communication. RS-232: 1200 / 2400 / 4800 / 9600 / 19200 / 38400 / 57600 / 115200 RS-485 can use higher baud rate for 230400 and 460800. It depends on the cable length and the installed environment. The longer cable, the lower baud rate for it.
<b>Data Bits</b>	8 is set by default	Select 8 or 7 for data bits.
<b>Stop Bits</b>	1 is set by default	Select 1 or 2 for stop bits.
<b>Flow Control</b>	None is set by default	Select None / RTS, CTS / DTS, DSR for Flow Control in RS-232 mode. The supporting of Flow Control depends on the purchased model.
<b>Parity</b>	None is set by default	Select None / Even / Odd for Parity bit.
<b>Action</b>	N/A	Click <b>Edit</b> button to change the operation mode, or modify the parameters mentioned above for the serial interface communication.
<b>Save</b>	N/A	Click <b>Save</b> button to save the settings.
<b>Undo</b>	N/A	Click <b>Undo</b> button to cancel the settings.

# 4G IIoT Gateway

## 4.1.2 Virtual COM

Create a virtual COM port on user's PC/Host to provide access to serial device connected to the serial port on gateway. Therefore, users can access, control, and manage the connected serial device through Internet (fixed line, or cellular network) anywhere. This application is also known as Ethernet pass-through communication.

Operation Mode Definition for each Serial Port									
Serial Port	Operation Mode	Listen Port	Trust Type	Max Connection	Connection Control	Connection Idle Timeout	Alive Check Timeout	Enable	Action
SPort-0	Disable	4001 (1~65535)	Allow All	1	Always on	0 (0-3600secs)	0 (0-3600secs)	<input type="checkbox"/>	Edit

Virtual COM setting screen enables user to connect a Virtual COM port based device to the Internet. It allows user to access serial data remotely. There are Disable, TCP Client, TCP Server, UDP, and RFC2217 modes for remote accessing the connected serial device. These operation modes are illustrated as below.

### TCP Client Mode

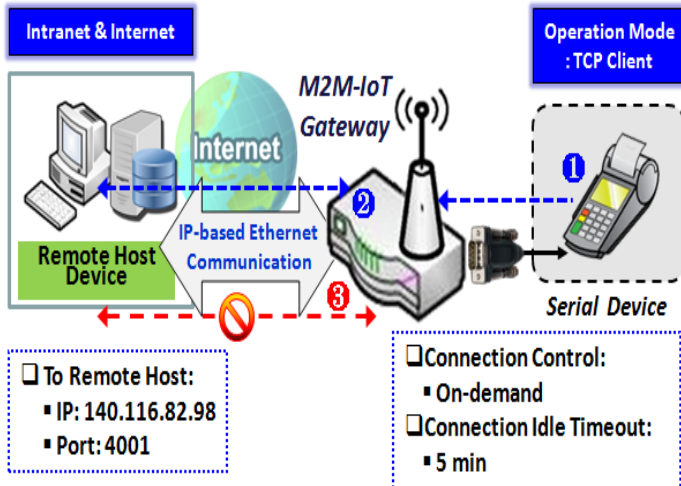

- 1 Gateway get Data received from Serial Device.
- 2 Establish a TCP Connection and Transmit Data to Remote Host.
- 3 Terminate this TCP Connection once Idle Timeout reached 5 mins.

When the administrator expects the gateway to actively establish a TCP connection to a pre-defined host computer when serial data arrives, the operation mode for the "Virtual COM" function is required to be "TCP Client" and when the connection control of virtual COM is "On-demand", once the gateway receives data from the connected serial device, it will establish a TCP connection to transfer the received serial data to the remote host. Besides, after the data has been transferred, the gateway automatically disconnects the established TCP session from the host computer by using the TCP alive check timeout or idle timeout settings.

# 4G IIoT Gateway

## TCP Server Mode

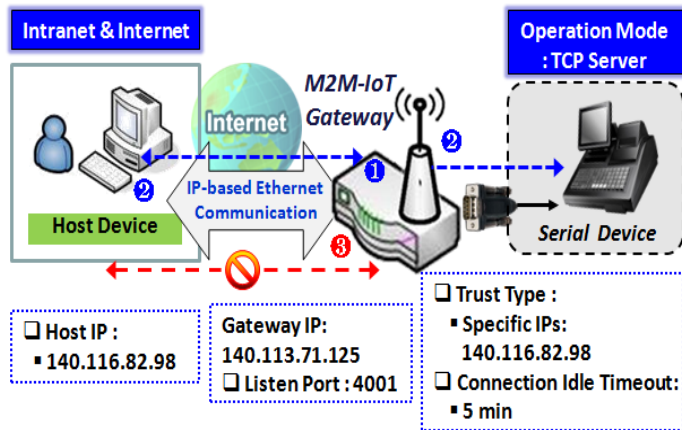

- Gateway remain Listening and Host will Establish a TCP Connection with it.
- Host Send Data then Gateway Transmit it to the Serial Device.
- Terminate this TCP Connection once Idle Timeout reached 5 mins.

When the administrator expects the gateway to wait passively for the serial data requests from the Host Device (usually we use a computer to play as a Host), and the Host will establish a TCP connection to get data from the serial device, the operation mode for the "Virtual COM" function is required to be "TCP Server". In this mode, the gateway provides a unique "IP: Port" address on a TCP/IP network. It supports up to 4 simultaneous connections, so that multiple hosts can collect data from the same serial device at the same time. After the data has been transferred, the TCP connection will be automatically disconnected from the host computer by using the TCP alive check timeout or idle timeout settings.

## UDP Mode

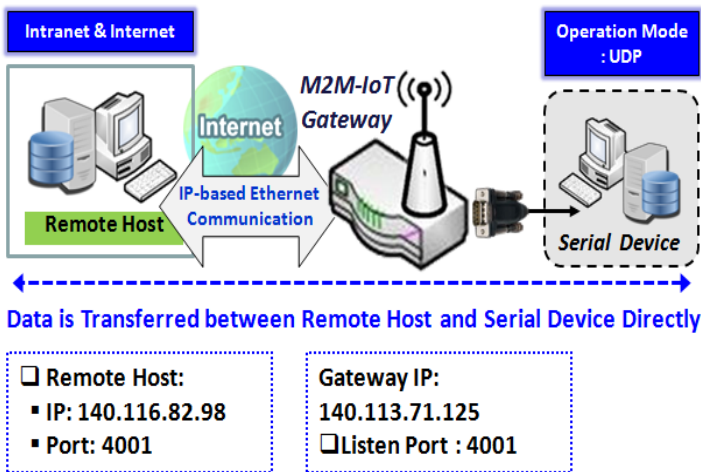

Data is Transferred between Remote Host and Serial Device Directly

If both the Remote Host Computer and the serial device are expected to initiate a data transfer when it requires doing that, the operation mode for the "Virtual COM" function in the gateway is required to be "UDP". In this mode, the UDP data can be transferred between the gateway and multiple host computers from either peer, making this mode ideal for message display applications.

The remote host computer can directly send UDP data to the serial device via the gateway, and also receive UDP data from the serial device via the gateway at the same time. The gateway supports up to 4 legal hosts to connect simultaneously to the serial device via the gateway.

# 4G IIoT Gateway

## RFC-2217 Mode

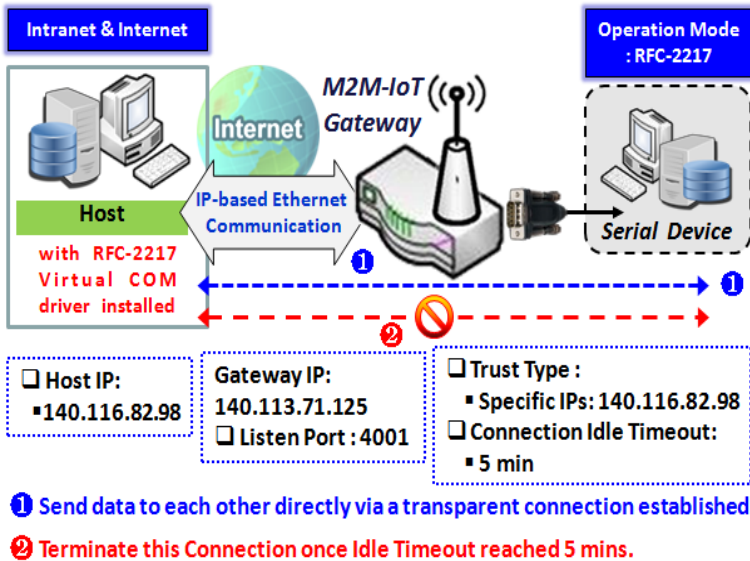

RFC-2217 defines general COM port control options based on telnet protocol. A host computer with RFC-2217 driver installed can monitor and manage the remote serial device attached to the gateway's serial port, as though they were connected to the local serial port. When a virtual serial port on the local serial device is being created, it is required to specify the IP-address of the host computers to establish connection with.

Any 3rd party driver supporting RFC2217 can be used to install in the host computer, the driver establishes a transparent connection between host and serial device by mapping the IP:Port of the gateway's serial port to a virtual local COM

port on the host computer.

The host computer can directly send data to the serial device via the gateway, and also receive data from the serial device via the gateway at the same time. The gateway supports up to 4 Internet host computers.

# 4G IIoT Gateway

## Virtual COM Setting

Virtual COM setting screen enables user to connect a Virtual COM port based device to the Internet. It allows user to access serial data remotely. There are Disable, TCP Client, TCP Server, UDP, and RFC2217 modes for remote accessing the connected serial device. By default, it is configured in Disable mode.

To use the Virtual COM function, you have to specify the operation mode for the multi-function serial port first. Go to **Field Communication > Bus & Protocol > Port Configuration** tab, select the Virtual COM as expected operation mode, and finish the related port configuration as well.

After that, go to **Field Communication > Bus & Protocol > Virtual COM** tab for detailed configuration of Virtual COM setting.

### Enable TCP Client Mode

Configure the gateway as the TCP (Transmission Control Protocol) Client. In TCP Client mode, device initiates a TCP connection with a TCP server when there is data to transmit. Device disconnects from the server when the connection is Idle for a specified period. You may also enable full time connection with the TCP server.

Operation Mode Definition for each Serial Port									
Serial Port	Operation Mode	Listen Port	Trust Type	Max Connection	Connection Control	Connection Idle Timeout	Alive Check Timeout	Enable	Action
SPort-0	TCP Client	N/A	N/A	N/A	Always on	N/A	N/A	<input type="checkbox"/>	Edit

Enable TCP Client Mode Window		
Item	Value setting	Description
<b>Operation Mode</b>	A Must filled setting	Select <b>TCP Client</b> .
<b>Connection Control</b>	<b>Always on</b> is set by default	Choose <b>Always on</b> for a TCP full time connection. Otherwise, choose <b>On-Demand</b> to initiate TCP connection only when required to transmit and disconnect at idle timeout.
<b>Connection Idle Timeout</b>	1. 0 is set by default 2. Range 0 to 3600 sec.	Enter the idle timeout in minutes. The idle timeout is used to disconnect the TCP connection when idle time elapsed . Idle timeout is only available when <b>On-Demand</b> is selected in the <b>Connection Control</b> field. <b>Value Range:</b> 0 ~ 3600 seconds.
<b>Alive Check Timeout</b>	1. 0 is set by default 2. Range 0 to 3600 sec.	Enter the time period of alive check timeout. The TCP connection will be terminated if it doesn't receive response of alive-check longer than this timeout setting Alive check timeout is only available when <b>On-Demand</b> is selected in the <b>Connection Control</b> field. <b>Value Range:</b> 0 ~ 3600 seconds.
<b>Enable</b>	The box is unchecked by default.	Check the <b>Enable</b> box to activate the corresponding serial port in specified operation mode.
<b>Save</b>	N/A	Click the <b>Save</b> button to save the configuration

# 4G IIoT Gateway

## Specify Data Packing Parameters

Data Packing (for TCP Client, TCP Server and UDP operation mode)				
Serial Port	Data Buffer Length	Delimiter Character 1	Delimiter Character 2	Data Timeout Transmit
SPort-0	<input type="text" value="0"/> (0~1024)	<input type="text" value="0"/> (Hex) <input type="checkbox"/> Enable	<input type="text" value="0"/> (Hex) <input type="checkbox"/> Enable	<input type="text" value="0"/> (0~1000ms)

Data Packing Configuration		
Item	Value setting	Description
<b>Data Buffer Length</b>	1.An optional filled setting 2.Default value is 0	Enter the data buffer length for the serial port. <b>Value Range:</b> 0 ~ 1024.
<b>Delimiter Character 1</b>	1.An optional filled setting 2.Default value is 0	Check the <b>Enable</b> box to activate the Delimiter character 1, and enter the Hex code for it. <b>Value Range:</b> 0x00 ~ 0xFF.
<b>Delimiter Character 2</b>	1.An optional filled setting 2.Default value is 0	Check the <b>Enable</b> box to activate the Delimiter character 2, and enter the Hex code for it. <b>Value Range:</b> 0x00 ~ 0xFF.
<b>Data Timeout Transmit</b>	1.An optional filled setting 2.Default value is 0	Enter the data timeout interval for transmitting serial data through the port. By default, it is set to 0 and the timeout function is disabled. <b>Value Range:</b> 0 ~ 1000ms.
<b>Save</b>	N/A	Click the <b>Save</b> button to save the configuration

## Specify Remote TCP Server

Legal Host IP/ FQDN Definition (for TCP Client operation mode)					
ID	To Remote Host	Remote Port	Serial Port	Definition Enable	Action
1		4001	SPort-0	<input type="checkbox"/>	<input type="button" value="Edit"/>
2		4001	SPort-0	<input type="checkbox"/>	<input type="button" value="Edit"/>
3		4001	SPort-0	<input type="checkbox"/>	<input type="button" value="Edit"/>
4		4001	SPort-0	<input type="checkbox"/>	<input type="button" value="Edit"/>

Specify TCP Server Window		
Item	Value setting	Description
<b>To Remote Host</b>	A Must filled setting	Press <b>Edit</b> button to enter IP address or FQDN of the remote TCP server to transmit serial data.
<b>Remote Port</b>	1.A Must filled setting 2.Default value is 4001	Enter the TCP port number. This is the listen port of the remote TCP server. <b>Value Range:</b> 1 ~ 65535.
<b>Serial Port</b>	SPort-0 is set by default	Apply the TCP server connection for a selected serial port. Up to 4 TCP servers can be configured at the same time for each serial port.

# 4G IIoT Gateway

<b>Definition Enable</b>	The box is unchecked by default	Check the <b>Enable</b> box to enable the TCP server configuration.
<b>Save</b>	N/A	Click the <b>Save</b> button to save the configuration

## Enable TCP Server Mode

Configure the gateway as the TCP (Transmission Control Protocol) Server. The TCP Server waits for connections to be initiated by a remote TCP client device to receive serial data. The setting allows user to specify specific TCP clients or allow any to send serial data for serial data transmission bandwidth control and access control. The TCP Server supports up to 128 simultaneous connections to receive serial data from multiple TCP clients.

Operation Mode Definition for each Serial Port									
Serial Port	Operation Mode	Listen Port	Trust Type	Max Connection	Connection Control	Connection Idle Timeout	Alive Check Timeout	Enable	Action
SPort-0	TCP Server	4001	Allow All	1	N/A	0 sec(s)	0 sec(s)	<input type="checkbox"/>	Edit

Enable TCP Server Mode Window		
Item	Value setting	Description
<b>Operation Mode</b>	A Must filled setting	Select <b>TCP Server</b> mode.
<b>Listen Port</b>	4001 is set by default	Indicate the listening port of TCP connection. <b>Value Range:</b> 1 ~ 65535.
<b>Trust Type</b>	<b>Allow All</b> is set by default	Choose <b>Allow All</b> to allow any TCP clients to connect. Otherwise choose <b>Specific IP</b> to limit certain TCP clients.
<b>Max Connection</b>	1. Max. 128 connections 2. 1 is set by default	Set the maximum number of concurrent TCP connections. Up to 128 simultaneous TCP connections can be established. <b>Value Range:</b> 1 ~ 128.
<b>Connection Idle Timeout</b>	1. 0 is set by default 2. Range 0 to 3600 sec.	Enter the idle timeout in minutes. The idle timeout is used to disconnect the TCP connection when idle time elapsed . Idle timeout is only available when <b>On-Demand</b> is selected in the <b>Connection Control</b> field. <b>Value Range:</b> 0 ~ 3600 seconds.
<b>Alive Check Timeout</b>	1. 0 is set by default 2. Range 0 to 3600 sec.	Enter the time period of alive check timeout. The TCP connection will be terminated if it doesn't receive response of alive-check longer than this timeout setting Alive check timeout is only available when <b>On-Demand</b> is selected in the <b>Connection Control</b> field. <b>Value Range:</b> 0 ~ 3600 seconds.
<b>Enable</b>	The box is unchecked by default.	Check the <b>Enable</b> box to activate the corresponding serial port in specified operation mode.
<b>Save</b>	N/A	Click <b>Save</b> button to save the settings.

# 4G IIoT Gateway

## Specify TCP Clients for TCP Server Access

If you selected **Specific IPs** as the trust Type, the Trusted IP Definition window appears. The settings are valid for both TCP Server and RFC-2217 modes.

Trusted IP Definition (for TCP Server & RFC-2217 operation mode)				
ID	Host	Serial Port	Definition Enable	Action
1			<input type="checkbox"/>	Edit
2			<input type="checkbox"/>	Edit
3			<input type="checkbox"/>	Edit
4			<input type="checkbox"/>	Edit
5			<input type="checkbox"/>	Edit
6			<input type="checkbox"/>	Edit
7			<input type="checkbox"/>	Edit
8			<input type="checkbox"/>	Edit

Specify TCP Clients Window		
Item	Value setting	Description
<b>Host</b>	A Must filled setting	Enter the IP address range of allowed TCP clients.
<b>Serial Port</b>	The box is unchecked by default	Check the box to specify the rule for selected Serial Port.
<b>Definition Enable</b>	The box is unchecked by default	Check the <b>Enable</b> box to enable the rule.
<b>Save</b>	N/A	Click <b>Save</b> to save the settings
<b>Undo</b>	N/A	Click <b>Undo</b> to cancel the settings

## Enable UDP Mode

UDP (User Datagram Protocol) enables applications using UDP socket programs to communicate with the serial ports on the serial server. The UDP mode provides connectionless communications, which enable you to multicast data from the serial device to multiple host computers, and vice versa, making this mode ideal for message display applications.

Operation Mode Definition for each Serial Port									
Serial Port	Operation Mode	Listen Port	Trust Type	Max Connection	Connection Control	Connection Idle Timeout	Alive Check Timeout	Enable	Action
SPort-0	UDP	4001	N/A	N/A	N/A	N/A	N/A	<input type="checkbox"/>	Edit

# 4G IIoT Gateway

Enable UDP Mode Window		
Item	Value setting	Description
<b>Operation Mode</b>	A Must filled setting	Select <b>UDP</b> mode.
<b>Listen Port</b>	4001 is set by default	Indicate the listening port of UDP connection. <b>Value Range:</b> 1 ~ 65535
<b>Enable</b>	The box is unchecked by default.	Check the <b>Enable</b> box to activate the corresponding serial port in specified operation mode.
<b>Save</b>	N/A	Click <b>Save</b> to save the settings
<b>Undo</b>	N/A	Click <b>Undo</b> to cancel the settings

## Specify Remote UDP

Legal Host IP Definition (for UDP operation mode)					
ID	Remote Host	Remote Port	Serial Port	Definition Enable	Action
1		4001	SPort-0	<input type="checkbox"/>	Edit
2		4001	SPort-0	<input type="checkbox"/>	Edit
3		4001	SPort-0	<input type="checkbox"/>	Edit
4		4001	SPort-0	<input type="checkbox"/>	Edit

Specify Remote UDP hosts Window		
Item	Value setting	Description
<b>Host</b>	A Must filled setting	Press <b>Edit</b> button to enter IP address range of remote UDP hosts.
<b>Remote Port</b>	4001 is set by default	Indicate the UDP port of peer UDP hosts. <b>Value Range:</b> 1 ~ 65535
<b>Serial Port</b>	SPort-0 is set by default	Apply the UDP hosts for a selected serial port. Up to 4 UDP servers can be configured at the same time for each serial port.
<b>Definition Enable</b>	The box is unchecked by default	Check the <b>Enable</b> box to enable the rule.
<b>Save</b>	N/A	Click <b>Save</b> to save the settings
<b>Undo</b>	N/A	Click <b>Undo</b> to cancel the settings

# 4G IIoT Gateway

## Enable RFC-2217 Mode

RFC-2217 defines general COM port control options based on telnet protocol. With the RFC-2217 mode, remote host can monitor and manage remote serially attached devices, as though they were connected to the local serial port. When a virtual serial port on the local serial device is being created, it is required to specify the IP-address of the remote hosts to establish connection with.

Operation Mode Definition for each Serial Port									
Serial Port	Operation Mode	Listen Port	Trust Type	Max Connection	Connection Control	Connection Idle Timeout	Alive Check Timeout	Enable	Action
SPort-0	RFC-2217	4001	Allow All	N/A	N/A	0 sec(s)	0 sec(s)	<input type="checkbox"/>	Edit

Enable RFC-2217 Mode Window		
Item	Value setting	Description
<b>Operation Mode</b>	A Must filled setting	Select <b>RFC-2217</b> mode.
<b>Listen Port</b>	4001 is set by default	Indicate the listening port of RFC-2217 connection. <b>Value Range:</b> 1 ~ 65535
<b>Trust Type</b>	<b>Allow All</b> is set by default	Choose <b>Allow All</b> to allow any clients to connect. Otherwise choose <b>Specific IP</b> to limit certain clients.
<b>Connection Idle Timeout</b>	1. 0 is set by default 2. Range 0 to 3600 sec.	Enter the idle timeout in minutes. The idle timeout is used to disconnect the TCP connection when idle time elapsed . Idle timeout is only available when <b>On-Demand</b> is selected in the <b>Connection Control</b> field. <b>Value Range:</b> 0 ~ 3600 seconds.
<b>Alive Check Timeout</b>	1. 0 is set by default 2. Range 0 to 3600 sec.	Enter the time period of alive check timeout. The TCP connection will be terminated if it doesn't receive response of alive-check longer than this timeout setting Alive check timeout is only available when <b>On-Demand</b> is selected in the <b>Connection Control</b> field. <b>Value Range:</b> 0 ~ 3600 seconds.
<b>Enable</b>	The box is unchecked by default.	Check the <b>Enable</b> box to activate the corresponding serial port in specified operation mode.
<b>Save</b>	N/A	Click <b>Save</b> to save the settings
<b>Undo</b>	N/A	Click <b>Undo</b> to cancel the settings

# 4G IIoT Gateway

## Specify Remote Host for Access

If you selected **Specific IPs** as the trust Type, the Trusted IP Definition window appears. The settings are valid for both TCP Server and RFC-2217 modes.

Trusted IP Definition (for TCP Server & RFC-2217 operation mode)				
ID	Host	Serial Port	Definition Enable	Action
1			<input type="checkbox"/>	Edit
2			<input type="checkbox"/>	Edit
3			<input type="checkbox"/>	Edit
4			<input type="checkbox"/>	Edit
5			<input type="checkbox"/>	Edit
6			<input type="checkbox"/>	Edit
7			<input type="checkbox"/>	Edit
8			<input type="checkbox"/>	Edit

Specify RFC-2217 Clients for Access Window		
Item	Value setting	Description
<b>Host</b>	A Must filled setting	Enter the IP address range of allowed clients.
<b>Serial Port</b>	The box is unchecked by default	Check the box to specify the rule for selected Serial Port.
<b>Definition Enable</b>	The box is unchecked by default	Check the <b>Enable</b> box to enable the rule.
<b>Save</b>	N/A	Click <b>Save</b> to save the settings
<b>Undo</b>	N/A	Click <b>Undo</b> to cancel the settings

# 4G IIoT Gateway

## 4.1.3 Modbus

Modbus is one of the most popular automation protocols in the world, supporting traditional RS-232/422/485 devices and recently developed Ethernet devices. Many industrial devices, such as PLCs, DCSs, HMIs, instruments, and smart meters, use Modbus protocol as the communication standard. It is used to establish master-slave communication between intelligent devices.

However, the Ethernet-based Modbus protocol is so different from the original serial-based protocols. In order to integrate Modbus networks, the IoT Gateway, including one or more serial ports that support RS-232 and RS-485 communication interface, can automatically and intelligently translate between Modbus TCP (Ethernet) and Modbus RTU/ASCII (serial) protocols, allowing Ethernet-based PLCs to control instruments over RS-485 without additional programming or effort.

Serial Port Definition								
Serial Port	Operation Mode	Interface	Baud Rate	Data Bits	Stop Bits	Flow Control	Parity	Action
SPort-0	Modbus	RS-485	115200	8	1	None	None	Edit

NOTE: When Modbus devices are connected to/under the same serial port of IoT Modbus Gateway, those Modbus devices must use the same protocol with the same configuration (i.e., either Modbus RTU or Modbus ASCII with same Baud Rate setting).

### Modbus Gateway Scenario

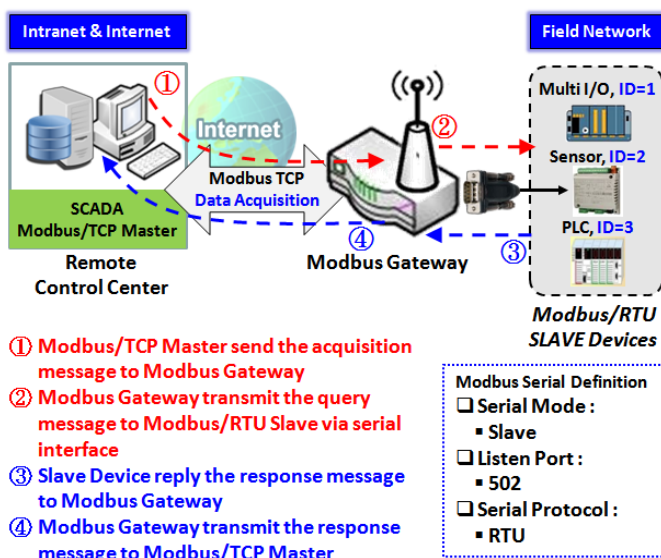

The IoT Gateway serves as a Modbus gateway to communicate with the Modbus TCP Master, the SCADA Server, located at remote control center for Modbus device accessing.

The Modbus TCP Master requests the IoT Gateway for Modbus devices' information, e.g., Data Acquisition or Register/Value Modification, via general Internet accessing, and the IoT Gateway serves as the gateway for data forwarding.

Under such configuration, the Modbus TCP Master requests the information from or sending control commands to various Modbus/RTU Slave devices that attached to the Modbus Gateway. And the Modbus gateway executes corresponding processes and replies the Modbus/TCP Master with the results.

# 4G IIoT Gateway

## Modbus Slave Scenario

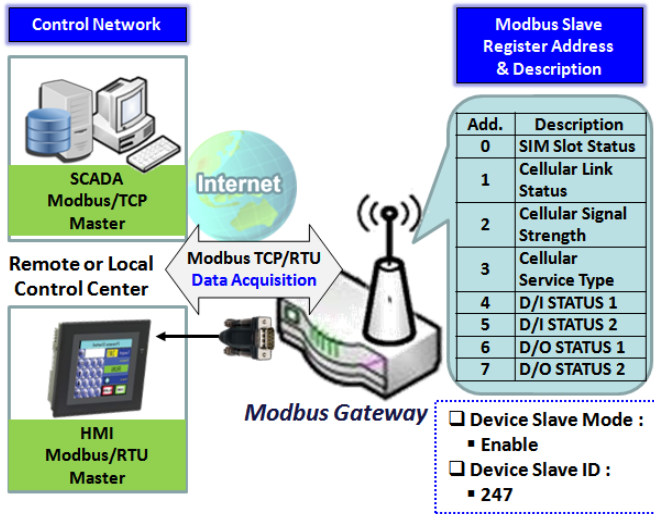

In addition to behave as a Modbus Gateway, there is an integrated Modbus Slave option for providing some device status, like Cellular Network Status, device DI/DO status, to remote Modbus Master via Modbus communication.

With the Slave option enabled, the Modbus Master device can request the information or sending control commands to the IoT Gateway, the Modbus TCP/RTU Slave device. And IoT Gateway executes corresponding processes and replies the Modbus Master devices.

# 4G IIoT Gateway

## Modbus Setting

Go to **Field Communication > Bus & Protocol > Modbus** tab.

The Modbus setting page enables user to configure the gateway to operate as a Modbus gateway, and allow access among Modbus TCP devices (which are connected to Ethernet network) and Modbus RTU/ASCII devices (which are connected to the Serial Port of the gateway). Once completed the Modbus settings in this section, ensure to select Modbus Operation Mode in Port Configuration screen to enable Modbus communication on the serial port.

### Define Modbus Gateway function for each Serial Port

Modbus Gateway Definition						
Serial Port	Gateway Mode	Device Slave Mode	Listen Port	Serial Protocol	Enable	Action
▶ SPort-0	Disable	Slave Mode: Disable	502	RTU	<input type="checkbox"/>	Edit

Modbus Gateway Definition		
Item	Value setting	Description
<b>Serial Port</b>	N/A	It displays the name of the serial port used. E.g. SPort-0. The number of serial ports varies from the purchased model.
<b>Gateway Mode</b>	<b>Disable</b> is set by default	Specify the Modbus gateway mode for the selected serial port. It can be <b>Disable</b> , <b>Serial as Slave</b> or <b>Serial as Master</b> . A serial port can be attached with one Modbus Master, or daisy-chained a group of Modbus Slave devices.  <b>Disable:</b> Select this to disable the respective Modbus gateway function for the selected serial port. <b>Serial as Slave:</b> Select this when the attached serial device(s) are all Modbus Slave devices. <b>Serial as Master:</b> Select this when the attached serial device is a Modbus Master device.
<b>Device Slave Mode</b>	The box is unchecked by default.	Check the <b>Enable</b> box to activate the integrated Modbus Slave function, and enter the preferred ID for the integrated Modbus slave. So that, it can function as a Modbus Slave device, and can be accessed with legacy Modbus Function Code from a SCADA management system. Supported Modbus commands are listed in the following Table.  <b>Value Range:</b> 1 ~ 247.
<b>Listen Port</b>	1. <b>502</b> is set by default 2. Range 1 to 65535	Specify the Listen Port number if Slave device(s) is attached to the selected serial port. It is a don't care setting if a Master device is attached.

# 4G IIoT Gateway

		<p><b>Value Range:</b> 1 ~ 65535.</p> <p>Note: Use different port number among the serial ports for the product with multiple serial ports.</p>
<b>Serial Protocol</b>	RTU is set by default	Select the serial protocol that is adopted by the attached Modbus device(s). It can be <b>RTU</b> or <b>ASCII</b> .
<b>Enable</b>	N/A	It displays whether the specific Modbus serial port is enabled or disabled. To enable or disable Modbus serial port, go to <b>Field Communication &gt; Bus &amp; Protocol &gt; Port Configuration</b> tab, and set the operation mode as <b>Modbus</b> .

## Specify Gateway Configuration

Gateway Mode Configuration for SPort-0	
Item	Setting
▶ Response Timeout	<input type="text" value="1000"/> ms (1~65535)
▶ Timeout Retries	<input type="text" value="0"/> times (0~5)
▶ 0Bh Exception	<input type="checkbox"/> Enable
▶ Tx Delay	<input type="checkbox"/> Enable
▶ TCP Connection Idle Time	<input type="text" value="300"/> sec (1~65535)
▶ Maximum TCP Connections	<input type="text" value="1"/> connections (1~4)
▶ TCP Keep-alive	<input type="checkbox"/> Enable
▶ Modbus Master IP Access	<input type="text" value="Allow All"/> ▼
▶ Message Buffering	<input type="checkbox"/> Enable

Gateway Mode Configuration for SPort-n		
Item	Value setting	Description
<b>Response Timeout</b>	<b>1000 ms</b> is set by default	<p>This sets the response timeout of the slave after master request sent. If the slave does not response within the specified time, data would be discarded.</p> <p>This applies to the serially attached Master sent request over to the remote Slave or requests send from the remote Master sent to the serially attached Slave.</p> <p><b>Value Range:</b> 1 ~ 65535.</p>
<b>Timeout Retries</b>	<b>0</b> is set by default	<p>If the slave does not respond to the Master's request, the gateway will resend the request stored in the buffer. If Timeout retries is set to null (value zero), the gateway would not buffer Master requests. If a value other than zero is specified, the gateway would store the Master request in the buffer and retries to send the request in a number of specified times.</p> <p>Once the retries are exhausted, the gateway will send a Modbus error message</p>

# 4G IIoT Gateway

		to the Master. However, if the 0Bh exception box is checked (see below), a 0Bh hex code based-error message will be send instead. <b>Value Range:</b> 0 ~ 5.
<b>0Bh Exception</b>	The box is unchecked by default.	Check the <b>Enable</b> box to enable gateway to send a 0Bh exception code message to Modbus Master to indicate that the slave device does not respond within the timeout interval.
<b>Tx Delay</b>	The box is unchecked by default.	Check the <b>Enable</b> box to activate to the minimum amount of time after receiving a response before the next message can be sent out. When Tx Delay is enabled the Gateway would insert a Tx delay between Master requests. The delay gives sufficient time for the slave devices to turn their transmitters off and their receivers back on.

## Setup TCP/IP Connection for Receiving Modbus Master Request

The following Modbus TCP Configuration items allow user to set up the TCP connection settings so that the remote Modbus Master can access to the Modbus gateway. Besides, it also allows user to specify authorized masters on the TCP network.

Item	Value setting	Description
<b>TCP Connection Idle Time</b>	1. <b>300</b> is set by default 2. Range 1 to 65535	Enter the idle timeout in seconds. If the gateway does not receive another TCP request before the idle timeout elapsed, the TCP session will be terminated automatically. <b>Value Range:</b> 1 ~ 65535.
<b>Maximum TCP Connections</b>	1. 4 is set by default 2. Range 1 to 4	Enter the allowed maximum simultaneous TCP connections. <b>Value Range:</b> 1 ~ 4.
<b>TCP Keep-alive</b>	The box is unchecked by default.	Check the <b>Enable</b> box to ensure to keep the TCP session connected.
<b>Modbus Master IP Access</b>	<b>Allow All</b> is selected by default.	Specify authorized masters on the TCP network. Select <b>Allow All</b> to allow any Modbus Master to reach the attached Slave(s). Otherwise, limit only specific Master to reach the Slave(s) by selecting <b>Specific IPs</b> . When <b>Specific IPs</b> is selected, a Trusted IP Definition dialog will appear.

## Specify Trusted Modbus Masters on the TCP network

When **Specific IPs** is selected, user has to specify the Master(s) by their IP addresses to reach the serially attached Slave(s).

# 4G IIoT Gateway

▶ Modbus Master IP Access	Specific IPs ▼			
▶ Trusted IP Definition	<b>ID</b>	<b>Source IP</b>	<b>Enable</b>	<b>Action</b>
	1	Specific IP Address ▼ <input type="text"/>	<input type="checkbox"/>	Edit
	2		<input type="checkbox"/>	Edit
	3		<input type="checkbox"/>	Edit
	4		<input type="checkbox"/>	Edit

Item	Value setting	Description
<b>Source IP</b>	A Must fill setting	<p>Select <b>Specific IP Address</b> to only allow an IP address of the allowed Master to access the attached Slave(s).</p> <p>Select <b>IP Range</b> to only allow a set range of IP addresses of the allowed Master to access the attached Slave(s).</p> <p>Select <b>IP Address-based Group</b> to only allow pre-defined group of IP address of the allowed Master to access the attached Slave(s).</p> <p>Note: group must be pre-defined before this selection become available. Refer to <b>Object Definition &gt; Grouping &gt; Host grouping</b>. You may also access to create a group by the Add Rule shortcut button. Setting done through the Add Rule button will also appear in the Host grouping setting screen.</p> <p>Then check <b>Enable</b> box to enable this rule.</p>
<b>Enable</b>	Unchecked by default	Check the <b>Enable</b> box to enable this rule.

## Modbus Priority Definition

Message Buffering must be enabled to prioritize Master request queue to transmit to Modbus Slave as mentioned in the above. Click the **Edit** button to fill in the priority settings.

▶ Message Buffering	<input checked="" type="checkbox"/> Enable			
▶ Modbus Priority Definition	<b>Modbus Priority</b>	<b>Priority Base</b>	<b>Enable</b>	<b>Action</b>
	▶ Modbus Priority 1	IP Address ▼ <input type="text"/>	<input type="checkbox"/>	Edit
	▶ Modbus Priority 2		<input type="checkbox"/>	Edit
	▶ Modbus Priority 3		<input type="checkbox"/>	Edit
	▶ Modbus Priority 4		<input type="checkbox"/>	Edit

# 4G IIoT Gateway

Item	Value setting	Description
<b>Message Buffering</b>	1. Unchecked by default 2. Buffer up to 32 requests	Check the <b>Enable</b> box to buffer up to 32 requests from Modbus Master. If the <b>Enable</b> box is checked, a Modbus Priority Definition dialog will appear consequently. So that, the buffered Master requests can further be configured to prioritize request queue to transmit to Slave based on Master's IP address if requests are coming from remote Master, or based on remote Slave ID if requests are coming from serially attached Master, or based on Function Code.
<b>Modbus Priority</b>	N/A	A Priority List for setting the priority of specified Modbus identity. Modbus Priority 1 ~ Modbus Priority 4.
<b>Priority Base</b>	IP Address by Default	User can specify a Modbus identity with <b>IP Address</b> , <b>Slave ID</b> , or <b>Function Code</b> . The buffered Modbus message that matched the specified identity will be handled with given priority.  The Modbus Master requests can be buffered to a certain priority queue according to the Master's IP address if requests are coming from remote Master, or the remote Slave's device ID if requests are coming from serially attached Master, or the specific Function Code that issued by Master.
<b>Enable</b>	Unchecked by default	Check the <b>Enable</b> box to enable the priority settings.
<b>Save</b>	N/A	Click the <b>Save</b> button to save the settings.

## Specify Modbus TCP Slave device(s)

If there is a Modbus Master device is attached to a certain serial port of the Modbus Gateway, user has to further specify the Modbus TCP Slave device(s) to send requests to from the attached Modbus RTU/ASCII Master device.

Modbus TCP Slave List for SPort-0 <input type="button" value="Add"/> <input type="button" value="Delete"/>					
ID	IP	Port	ID Range	Enable	Actions

When the **Add** button is applied, a **Modbus TCP Slave Configuration** screen will appear.

Modbus TCP Slave Configuration for SPort-0	
Item	Setting
▶ IP	<input type="text"/>
▶ Port	<input type="text"/> (1~65535)
▶ ID Range	<input type="text"/> (1~247) ~ <input type="text"/> (1~247)
▶ Enable	<input type="checkbox"/>

Modbus Remote Slave Configuration		
Item	Value setting	Description
<b>IP</b>	A Must fill setting	Enter the IP address of the remote Modbus TCP Slave device.
<b>Port</b>	1. A Must fill setting 2. Range 1 to 65535	Enter the TCP port on which the remote Modbus TCP Slave device listens (to the TCP client session request).  <b><u>Value Range: 1 ~ 65535.</u></b>

# 4G IIoT Gateway

---

<b>ID Range</b>	Range 1 to 247	Enter the Modbus ID range for the Modbus TCP Slave(s) that will respond to the Master's request. In addition to specify the Slave IP and Port, for accessing those Remote Modbus RTU Slave(s) located behind another Modbus Gateway, user has to specify the Modbus ID range of the Modbus RTU Slave(s). <b><i>Value Range: 1 ~ 247.</i></b>
<b>Enable</b>	It is unchecked by default.	Check the <b>Enable</b> box to enable this rule.
<b>Save</b>	N/A	Click the <b>Save</b> button to save the settings.

# 4G IIoT Gateway

## Supported Function Code for Integrated Modbus Slave

This setting can setup the Gateway as a standalone Modbus Slave Device. Local SCADA Management System can treat the Gateway as a Slave device, and hence is able to read its information for device monitoring.

Currently, the integrated Modbus Slave device supports the following commands for accessing the 3G/4G Modem Status of the Gateway.

**Function Code:** 0x03(/Read). 0x06(/Write)

**Address:** 0 ~ 9999

Register Address	Register Name	R / W	Register Range / Description
0	WAN-1 Connection Status	R	0 ~ 6, 0=Disconnected, 1=Connecting..., 2=Connected, 3=Disconnecting..., 5=Wait for Traffic..., 6=Diconnected
1	WAN-2 Connection Status	R	0 ~ 6, 0=Disconnected, 1=Connecting..., 2=Connected, 3=Disconnecting..., 5=Wait for Traffic..., 6=Diconnected
2	WAN-3 Connection Status	R	0 ~ 6, 0=Disconnected, 1=Connecting..., 2=Connected, 3=Disconnecting..., 5=Wait for Traffic..., 6=Diconnected
3	WAN-4 Connection Status	R	0 ~ 6, 0=Disconnected, 1=Connecting..., 2=Connected, 3=Disconnecting..., 5=Wait for Traffic..., 6=Diconnected
10	3G/4G_SERVICE_TYPE	R	0 ~ 7, 0=2G, 1=none, 2=3G, 3=3.5G, 4~6=3.75G, 7=LTE
11	3G/4G_LINK_STATUS	R	0 ~ 6, 0=Disconnected, 1=Connecting..., 2=Connected, 3=Disconnecting..., 5=Wait for Traffic..., 6=Diconnected
12	3G/4G_SIGNAL_STRENGTH	R	0 ~ 100
13	3G/4G_SIM_STATUS	R	0 : SIM card with PIN code insert 1 : SIM card ready 2 : No SIM card
14	3G/4G_MCC	R	MCC Value
15	3G/4G_MNC	R	MNC Value
16	3G/4G_CS Register Status	R	0 : Unregistered, 1: Registered
17	3G/4G_PS Register Status	R	0 : Unregistered, 1: Registered
18	3G/4G_Roaming Status	R	0 : Not Roaming, 1: Roaming
19	3G/4G_RSSI	R	RSSI Value
20	3G/4G_RSRP	R	RSRP Value
21	3G/4G_RSRQ	R	RSRQ Value
30	3G/4G_Module-2_SERVICE_TYPE	R	0 ~ 7, 0=2G, 1=none, 2=3G, 3=3.5G, 4~6=3.75G, 7=LTE
31	3G/4G_Module-2_LINK_STATUS	R	0 ~ 6, 0=Disconnected, 1=Connecting..., 2=Connected, 3=Disconnecting..., 5=Wait for Traffic..., 6=Diconnected
32	3G/4G_Module-2_SIGNAL_STRENGTH	R	0 ~ 100

# 4G IIoT Gateway

Register Address	Register Name	R / W	Register Range / Description
33	3G/4G_Module-2_SIM_STATUS	R	0 : SIM card with PIN code insert 1 : SIM card ready 2 : No SIM card
34	3G/4G_Module-2_MCC	R	MCC Value
35	3G/4G_Module-2_MNC	R	MNC Value
36	3G/4G_Module-2_CS Register Status	R	0 : Unregistered, 1: Registered
37	3G/4G_Module-2_PS Register Status	R	0 : Unregistered, 1: Registered
38	3G/4G_Module-2_Roaming Status	R	0 : Not Roaming, 1: Roaming
39	3G/4G_Module-2_RSSI	R	RSSI Value
40	3G/4G_Module-2_RSRP	R	RSRP Value
41	3G/4G_Module-2_RSRQ	R	RSRQ Value
70	ADSL_Download_Data_rate	R	ADSL Download Data rate value (kbps)
71	ADSL_Upload_Data_rate	R	ADSL Upload Data rate value (kbps)
72	ADSL_SNR_Download	R	ADSL SNR Download value (dB)
73	ADSL_SNR_Upload	R	ADSL SNR Upload value (dB)
74	ADSL_modem_link_status	R	0 : Disconnected, 1: Connected
101	VPN_IPSec_tunnel_1_status	R	1 : Connected, 2 : Wait for traffic , 3 : Disconnected , 9 : Connecting
102	VPN_IPSec_tunnel_2_status	R	1 : Connected, 2 : Wait for traffic , 3 : Disconnected , 9 : Connecting
103	VPN_IPSec_tunnel_3_status	R	1 : Connected, 2 : Wait for traffic , 3 : Disconnected , 9 : Connecting
104	VPN_IPSec_tunnel_4_status	R	1 : Connected, 2 : Wait for traffic , 3 : Disconnected , 9 : Connecting
105	VPN_IPSec_tunnel_5_status	R	1 : Connected, 2 : Wait for traffic , 3 : Disconnected , 9 : Connecting
106	VPN_IPSec_tunnel_6_status	R	1 : Connected, 2 : Wait for traffic , 3 : Disconnected , 9 : Connecting
107	VPN_IPSec_tunnel_7_status	R	1 : Connected, 2 : Wait for traffic , 3 : Disconnected , 9 : Connecting
108	VPN_IPSec_tunnel_8_status	R	1 : Connected, 2 : Wait for traffic , 3 : Disconnected , 9 : Connecting
109	VPN_IPSec_tunnel_9_status	R	1 : Connected, 2 : Wait for traffic , 3 : Disconnected , 9 : Connecting
110	VPN_IPSec_tunnel_10_status	R	1 : Connected, 2 : Wait for traffic , 3 : Disconnected , 9 : Connecting
111	VPN_IPSec_tunnel_11_status	R	1 : Connected, 2 : Wait for traffic , 3 : Disconnected , 9 : Connecting
112	VPN_IPSec_tunnel_12_status	R	1 : Connected, 2 : Wait for traffic , 3 : Disconnected , 9 : Connecting
113	VPN_IPSec_tunnel_13_status	R	1 : Connected, 2 : Wait for traffic , 3 : Disconnected , 9 : Connecting
114	VPN_IPSec_tunnel_14_status	R	1 : Connected, 2 : Wait for traffic , 3 : Disconnected , 9 : Connecting
115	VPN_IPSec_tunnel_15_status	R	1 : Connected, 2 : Wait for traffic , 3 : Disconnected , 9 : Connecting
116	VPN_IPSec_tunnel_16_status	R	1 : Connected, 2 : Wait for traffic , 3 : Disconnected , 9 : Connecting

# 4G IIoT Gateway

Register Address	Register Name	R / W	Register Range / Description
150	DI_STATUS_1	R	0 : OFF, 1 : ON
151	DO_STATUS_1	R/W	0 : OFF, 1 : ON
152	DI_STATUS_2	R	0 : OFF, 1 : ON
153	DO_STATUS_2	R/W	0 : OFF, 1 : ON
154	DI_STATUS_3	R	0 : OFF, 1 : ON
155	DO_STATUS_3	R/W	0 : OFF, 1 : ON
156	DI_STATUS_4	R	0 : OFF, 1 : ON
157	DO_STATUS_4	R/W	0 : OFF, 1 : ON
201	Serial Port-0 Interface	R	1 : RS-232, 3 : RS-485
202	Serial Port-0 Baud Rate	R	Baud Rate Value
203	Serial Port-0 Data Bits	R	7 or 8
204	Serial Port-0 Stop Bits	R	1 or 2
205	Serial Port-0 Flow Control	R	0 : None, 2 : RTS,CTS, 3 : DTR,DSR
206	Serial Port-0 Parity	R	0 : None, 1 : Odd, 2 : Even
211	Serial Port-1 Interface	R	1 : RS-232, 3 : RS-485
212	Serial Port-1 Baud Rate	R	Baud Rate Value
213	Serial Port-1 Data Bits	R	7 or 8
214	Serial Port-1 Stop Bits	R	1 or 2
215	Serial Port-1 Flow Control	R	0 : None, 2 : RTS,CTS, 3 : DTR,DSR
216	Serial Port-1 Parity	R	0 : None, 1 : Odd, 2 : Even
221	Serial Port-2 Interface	R	1 : RS-232, 3 : RS-485
222	Serial Port-2 Baud Rate	R	Baud Rate Value
223	Serial Port-2 Data Bits	R	7 or 8
224	Serial Port-2 Stop Bits	R	1 or 2
225	Serial Port-2 Flow Control	R	0 : None, 2 : RTS,CTS, 3 : DTR,DSR
226	Serial Port-2 Parity	R	0 : None, 1 : Odd, 2 : Even
231	Serial Port-3 Interface	R	1 : RS-232, 3 : RS-485
232	Serial Port-3 Baud Rate	R	Baud Rate Value
233	Serial Port-3 Data Bits	R	7 or 8
234	Serial Port-3 Stop Bits	R	1 or 2
235	Serial Port-3 Flow Control	R	0 : None, 2 : RTS,CTS, 3 : DTR,DSR
236	Serial Port-3 Parity	R	0 : None, 1 : Odd, 2 : Even
9999	System_Reboot	W	Set 1 for System reboot.

# 4G IIoT Gateway

## 4.2 Data Logging

Data logging is the process of collecting and storing data over a period of time in order to analyze specific trends or record the data-based events/actions of a system, or connected devices. Data logging function is a very useful and also important feature for SCADA telemetry; it makes the monitoring and analyzing tasks easier by checking the status and historical data during whole data acquisition period.

Even facing the network connection problems with remote NOC/SCADA side, you can also enable the data logging proxy function provided by the purchased gateway and keep doing the data acquisition and storing the collected data in local storage (in .CSV file format). When the network connection recovered, admin/user can download the data log files manually via FTP or web UI for further reference and maintenance.

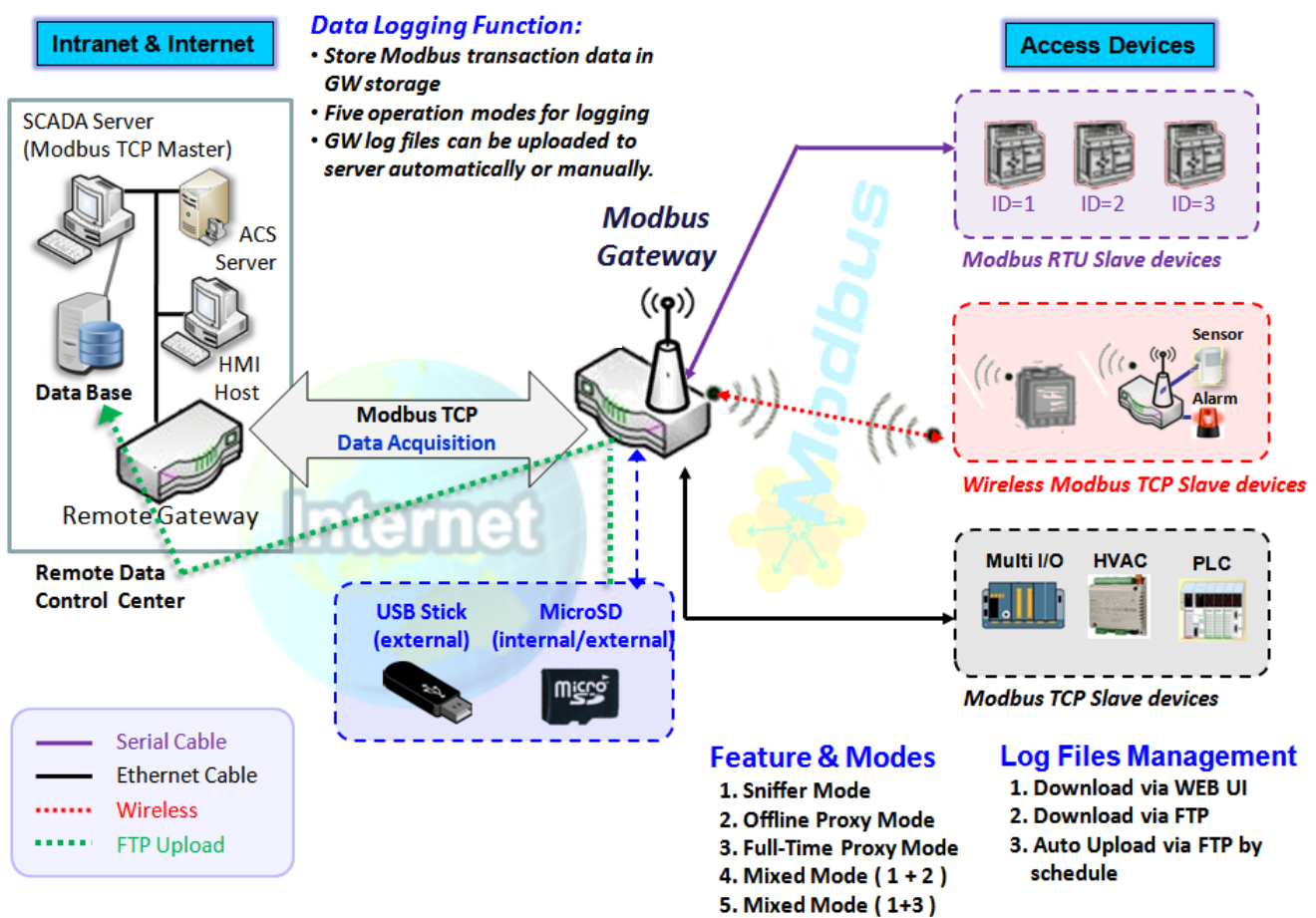

The Modbus Cellular Gateway provides a complete data logging function for collecting the Modbus transaction data for application requirements. There are some data logging schemes to meet different management requirements. They are the Sniffer Mode, Offline Proxy Mode, Full-Time Proxy Mode, and the mixed modes for sniffer and proxy combinations.

With the Sniffer mode enabled, the gateway will monitor and record the communication among a specific Modbus Master and related slaves. It will store the Modbus communication as log files and administrator can check what Modbus communication went over the Modbus gateway, and if there is any communication loss

# 4G IIoT Gateway

among the Master and Slave sides or not.

However, if there is any network connection problem between the Modbus gateway and remote NOC/SCADA, the remote Modbus server can't reach the Slave devices attached to the Modbus gateway, and consequently, nothing can be monitored and stored under such situation.

With the Proxy mode option enabled, when the Modbus gateway lost the connection with specified Modbus server, it will take over the data acquisition task and keep collecting the required data from Slave devices automatically. Once the connection is recovered, the Modbus gateway may stop the data log proxy function. Remote Modbus server can keep its data acquisition process, and if required, the administrator can also get the stored data log files to tell if everything goes well or not.

Under the Data Logging Proxy mode, user has to create some data acquisition rules via "Proxy Mode Rule Configuration" for collecting the Slave devices data by the Gateway when required. Once the network connection to remote SCADA was lost unexpectedly, the Data Logging Proxy function will be triggered and begin to do the data polling tasks by those pre-defined rules running in background.

## ➤ Scenario for Sniffer Mode Data Logging

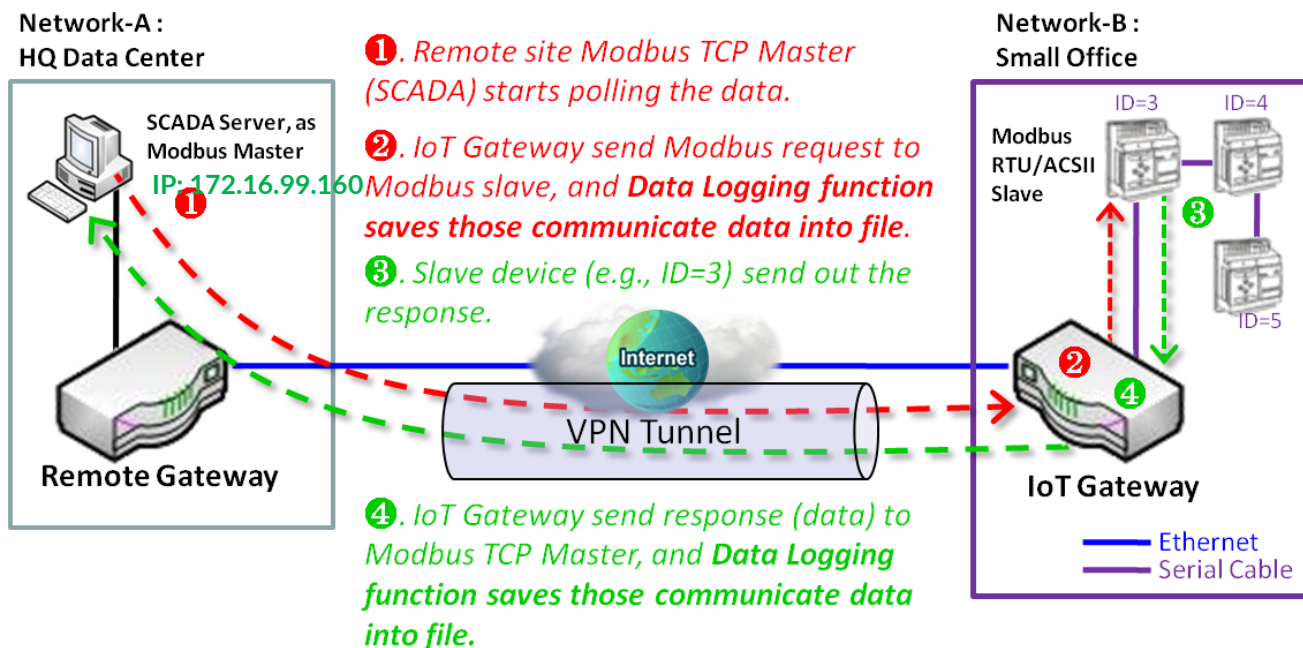

As Illustrated in the diagram, the Modbus gateway will store the following Modbus activities into a log file.

- The Modbus request sent from Remote Modbus TCP Master.
- The response (data) that sent out from the polled Slave device (ID=3)

## ➤ Scenario for Off-Line Proxy Mode Data Logging

# 4G IIoT Gateway

Network-A:  
HQ Data Center

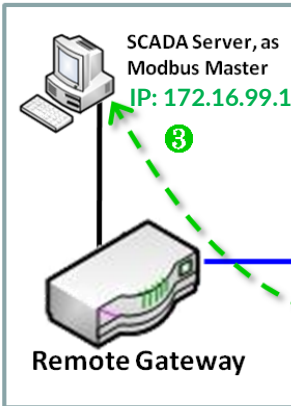

- 1 To do the Data-Acquisition by IoT Gateway itself automatically.
- 2 Save those data as files to internal or external storage unit (e.g., Micro-SD card).
- 3 Data Logging Files Downloading via FTP or WEB UI.

Network-B:  
Small Office

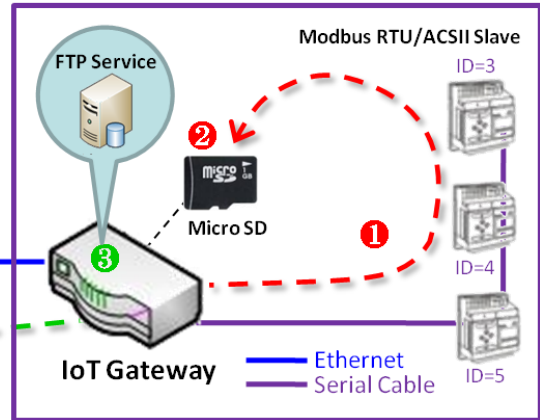

As illustrated, when the connection to a remote Modbus Master broken, the Modbus Gateway will activate the data logging proxy function and execute the pre-defined data acquisition task by itself.

- The Modbus request issued by the Modbus Gateway (Data Logging Proxy).
- The response (data) that sent out from the polled Slave device (ID=3)

Repeat above data acquisition and data logging activities on every 5 sec interval until the connection recovered.

# 4G IIoT Gateway

## 4.2.1 Data Logging Configuration

Data Logging is commonly used in monitoring systems to collect and analyze the field data. With proper configuration, the Gateway will record Modbus messages according to the specified rule list.

Go to **Field Communication > Data Logging > Configuration** tab.

### Enable Data Logging

Configuration	
Item	Setting
▶ Data Logging	<input type="checkbox"/> Enable
▶ Storage Device	External ▾

Configuration Item	Value setting	Description
<b>Data Logging</b>	The box is unchecked by default.	Check the <b>Enable</b> box to activate to data logging function.
<b>Storage Device</b>	<b>External</b> is set by default	Choose the sotrage device to store the log files. It can be <b>External</b> or <b>Internal</b> , depends on the product specification.
<b>Save</b>	NA	Click the <b>Save</b> button to save the settings.

Note:

1. If there is no available storage device, the Enable checkbox will be grayed, and you can't enable it for the data logging. That is, if you selected External Storage, plug-in the storage first, and then enable the function and also make the required configuration.
2. Make sure the Modbus Operation Mode is selected and enabled, or there will be no Modbus transactions to be logged. Please refer to **Field Communication > Bus & Protocol > Port Configuration** and **Modbus** tabs.

### Create/Edit Modbus Proxy Rules

The Gateway allows you to customize your proxy mode rule list. It supports up to a maximum of 20 rules.

Modbus Proxy Rule List <input type="button" value="Add"/> <input type="button" value="Delete"/>								
ID	Name	Modbus Slave Type	Slave ID	Function Code	Start Address	Number of Coils/Registers	Polling Rate (ms)	Actions

When the **Add** button is applied, **Modbus Proxy Rule Configuration** screen will appear.

# 4G IIoT Gateway

Modbus Proxy Rule List Configuration	
	<input type="button" value="Save"/> <input type="button" value="Undo"/>
Item	Setting
▶ Name	<input type="text"/>
▶ Modbus Slave Type	IP Address:Port ▼ <input type="text"/> : <input type="text"/>
▶ Slave ID	<input type="text"/> (1~247) - <input type="text"/> (1~247)
▶ Function Code	Read Coils (0x01) ▼
▶ Start Address	<input type="text"/> (0~65535)
▶ Number of Coils/Registers	<input type="text"/> (1~125)
▶ Polling Rate (ms)	<input type="text" value="1000"/> (500~99999)

Modbus Proxy Rule Configuration		
Item	Value setting	Description
<b>Name</b>	A Must filled setting.	Specify a name as the identifier of the Modbus proxy rule. <b>Value Range:</b> 1 ~ 32 characters.
<b>Modbus Slave Type</b>	IP Address :Port is selected by default.	Specify the Modbus Slave devices to apply with the Modbus proxy rule. It can be <b>IP Address:Port</b> for Modbus TCP slaves or <b>Local Serial Port</b> for local attached Modbus RTU/ASCII slaves. <b>Value Range:</b> 1 ~ 65535 for port number
<b>Slave ID</b>	1. A Must filled setting. 2. Range 1 to 247	Specify the ID range for the slave device(s) to apply with the Modbus proxy rule. <b>Value Range:</b> 1 ~ 247.
<b>Function Code</b>	<b>Read Coils (0x01)</b> is selected by default.	Specify a certain read function for the Data Logging Proxy to issue and record the responses from device(s).
<b>Start Address</b>	1. A Must filled setting. 2. Range 0 to 65535	Specify the Start Address of registers to apply with the specified function code. <b>Value Range:</b> 0 ~ 65535.
<b>Number of Coils/Registers</b>	1. A Must filled setting. 2. Range 1 to 125	Specify the number of coils/registers to apply with the specified function code. <b>Value Range:</b> 1 ~ 125. Note: <b>Start Address</b> plus <b>Number</b> must be smaller than 65536.
<b>Polling Rate (ms)</b>	1. A Must filled setting. 2. <b>1000</b> ms is set by default	Enter the poll time in milliseconds to apply the Proxy Mode Rule. Once the proxy mode is activated, the Modbus Gateway will issue pre-defined Modbus message on each Poll Time interval accordingly. <b>Value Range:</b> 500 ~ 99999.
<b>Save</b>	N/A	Click the <b>Save</b> button to save the settings.
<b>Undo</b>	N/A	Click the <b>Undo</b> button to cancel the changes.

# 4G IIoT Gateway

## 4.2.2 Scheme Setup

There are five data logging schemes to meet different management requirements. They are the Sniffer Mode, Offline Proxy Mode, Full-Time Proxy Mode, and the mixed modes for sniffer and proxy combinations. User has to configure the required data logging rules with selected scheme in this Scheme Setup page.

Go to **Field Communication > Data Logging > Scheme Setup** tab.

### Create/Edit Data Logging Rules

Scheme List <input type="button" value="Add"/> <input type="button" value="Delete"/>							
ID	Name	Mode	Master Type	Master Query Timeout (sec)	Proxy Rules	Enable	Actions

When the **Add** button is applied, **Scheme Configuration** screen will appear.

Scheme Configuration <input type="button" value="Save"/> <input type="button" value="Undo"/>	
Item	Setting
▶ Name	<input type="text"/>
▶ Mode	Sniffer ▼
▶ Master Type	IP Address ▼ <input type="text"/>
▶ Enable	<input type="checkbox"/>

Scheme Configuration		
Item	Value setting	Description
<b>Name</b>	A Must filled setting.	Specify a name as the identifier of the data logging rule. <b>Value Range: 1 ~ 16 characters.</b>
<b>Mode</b>	<b>Sniffer</b> is selected by default.	Select an expected data logging scheme for the data logging rule. There are five available schemes : <b>Sniffer</b> : The Modbus gateway will record all the Modbus transactions between the Master and Slave devices. <b>Off-Line Proxy</b> : When the connection between the Modbus gateway and Master is lost, the pre-defined proxy rule will be triggered and the Modbus gateway will issue specified function code to collect and record the data / status from the slave devices <b>Full-Time Proxy</b> : The pre-defined proxy rule will be triggered all the time and the Modbus gateway will issue specified function code to collect and record the data / status from the slave devices <b>Sniffer &amp; Off-Line Proxy</b> : This is a mixed mode for both Sniffer and Off-Line Proxy

## 4G IIoT Gateway

		<p>modes.</p> <p><b>Sniffer &amp; Full-Time Proxy:</b> This is a mixed mode for both Sniffer and Full-Time Proxy modes.</p>
<b>Master Type</b>	<b>IP Address</b> is selected by default.	Specify the Modbus master device to apply with the data logging rule. It can be <b>IP Address</b> for Modbus TCP master, or <b>Local Serial Port</b> for local attached Modbus RTU/ASCII master.
<b>Master Query Timeout (sec.)</b>	<ol style="list-style-type: none"> <li>1. An Optional setting.</li> <li>2. <b>60</b> sec is set by default</li> <li>3. Range 1 to 99999</li> </ol>	<p>Specify the timeout value for querying Modbus Master. If no response from the master for the specified timeout setting, selected proxy rule will be triggered and applied with the data logging rule.</p> <p>Note: If Off-Line proxy scheme is selected, the timeout setting will be used to check. Otherwise, it is a don't care value.</p>
<b>Proxy Rules</b>	An Optional setting.	<p>Select the Proxy rule to be applied with the data logging rule.</p> <p>Note: If any proxy scheme is selected, please create the required Proxy rules in advance, and select from the list.</p>
<b>Enable</b>	The box is unchecked by default.	Check the box to activate the data logging rule.
<b>Save</b>	N/A	Click the <b>Save</b> button to save the settings.
<b>Undo</b>	N/A	Click the <b>Undo</b> button to cancel the changes.

# 4G IIoT Gateway

## 4.2.3 Log File Management

There are five data logging schemes to meet different management requirements. They are the Sniffer Mode, Off-Line Proxy Mode, Full-Time Proxy Mode, and the mixed modes for sniffer and proxy combinations. User has to configure the required data logging rules with selected scheme in this Scheme Setup page.

Go to **Field Communication > Data Logging > Log File Management** tab.

If user had created data log rules in the **Field Communication > Data Logging > Scheme Setup** tab, there will be a log file list shown in the following Log File list screen. The default Log File management settings will be applied if user didn't change it via the **Edit** button.

Log File List								
ID	Name	File Content Format	Split File by	Auto Upload	Log File Compression	Delete File After Upload	When Storage Full	Actions
1	Sniffer Log	Raw Data	200 KB	Disabled	N/A	N/A	Remove the Oldest	<input type="button" value="Edit"/> <input type="button" value="Download Log"/>

When the **Edit** button is applied, **Log File Configuration** screen will appear.

Log File List Configuration	
Item	Setting
File Content Format	Raw Data ▾
Split File by	Size ▾ 200 KB ▾
Auto Upload	<input checked="" type="checkbox"/> Enable --- Option --- ▾ <input type="button" value="Add Object"/>
Log File Compression	<input type="checkbox"/> Enable
Delete File After Upload	<input type="checkbox"/> Enable
When Storage Full	Remove the Oldest ▾

Log File Configuration		
Item	Value setting	Description
<b>Name</b>	N/A	The name of corresponding data log rule will be displayed. The default log file name will be named as ' Name_YYYYMMddHHmmSS.csv '.
<b>File Content Format</b>	<b>Raw Data</b> is selected by default	Select the data format for the log files. It can be <b>Raw Data</b> , or <b>Modbus Type</b> .
<b>Split File by</b>	<b>Size</b> and <b>200 KB</b> are set by default	Specify the split file methodology. It can be by <b>Size</b> , or by <b>Time Interval</b> . User has to specify a certain file size or time interval for splitting the data logs into a series of files. <b>Value Range: 1 ~ 99999.</b>

## 4G IIoT Gateway

<b>Auto Upload</b>	<ol style="list-style-type: none"> <li>1. An Optional filled setting</li> <li>2. The box is unchecked by default.</li> </ol>	<p>Check the <b>Enable</b> box to activate the auto upload function for logged files. Once been enabled, user has to specify an external FTP server from the dropdown list for auto uploading the log files to the server. Refer to <b>Object Definition &gt; External Server &gt; External Server</b> tab, or create the FTP server with the <b>Add Object</b> button.</p>
<b>Log File Compression</b>	<ol style="list-style-type: none"> <li>1. An Optional filled setting</li> <li>2. The box is unchecked by default</li> </ol>	<p>If Auto Upload is activated, user can further specify whether to compress the log file prior it is uploaded or not. Check the <b>Enable</b> button to activate the Log File Compression function...</p>
<b>Delete File After Upload</b>	<ol style="list-style-type: none"> <li>1. An Optional filled setting</li> <li>2. The box is unchecked by default</li> </ol>	<p>If Auto Upload is activated, user can further specify whether to delete the transferred log from the gateway storage or not. Check the <b>Enable</b> button to activate the function.</p>
<b>When Storage Full</b>	<b>Remove the Oldest</b> is selected by default	<p>Specify the operation to take when the storage is full. It can be <b>Remove the Oldest</b> log file, or <b>Stop Recording</b>. When <b>Remove the Oldest</b> is selected, the gateway will delete the oldest file once the storage is full, and keep on the data logging activity; When <b>Stop Recording</b> is selected, the gateway will stop the data logging activity once the storage is full.</p>
<b>Save</b>	NA	Click the <b>Save</b> button to save the settings.
<b>Undo</b>	NA	Click the <b>Undo</b> button to cancel the changes.

When the **Download Log** button is applied, the web browser will download a file named as 'log.tar' to the managing host computer.

## Chapter 5 Security

### 5.1 VPN

A virtual private network (VPN) extends a private network across a public network, such as the Internet. It enables a computer to send and receive data across shared or public networks as if it were directly connected to the private network, while benefitting from the functionality, security and management policies of the private network. This is done by establishing a virtual point-to-point connection through the use of dedicated connections, encryption, or a combination of the two. The tunnel technology supports data confidentiality, data origin authentication and data integrity of network information by utilizing encapsulation protocols, encryption algorithms, and hashing algorithms.

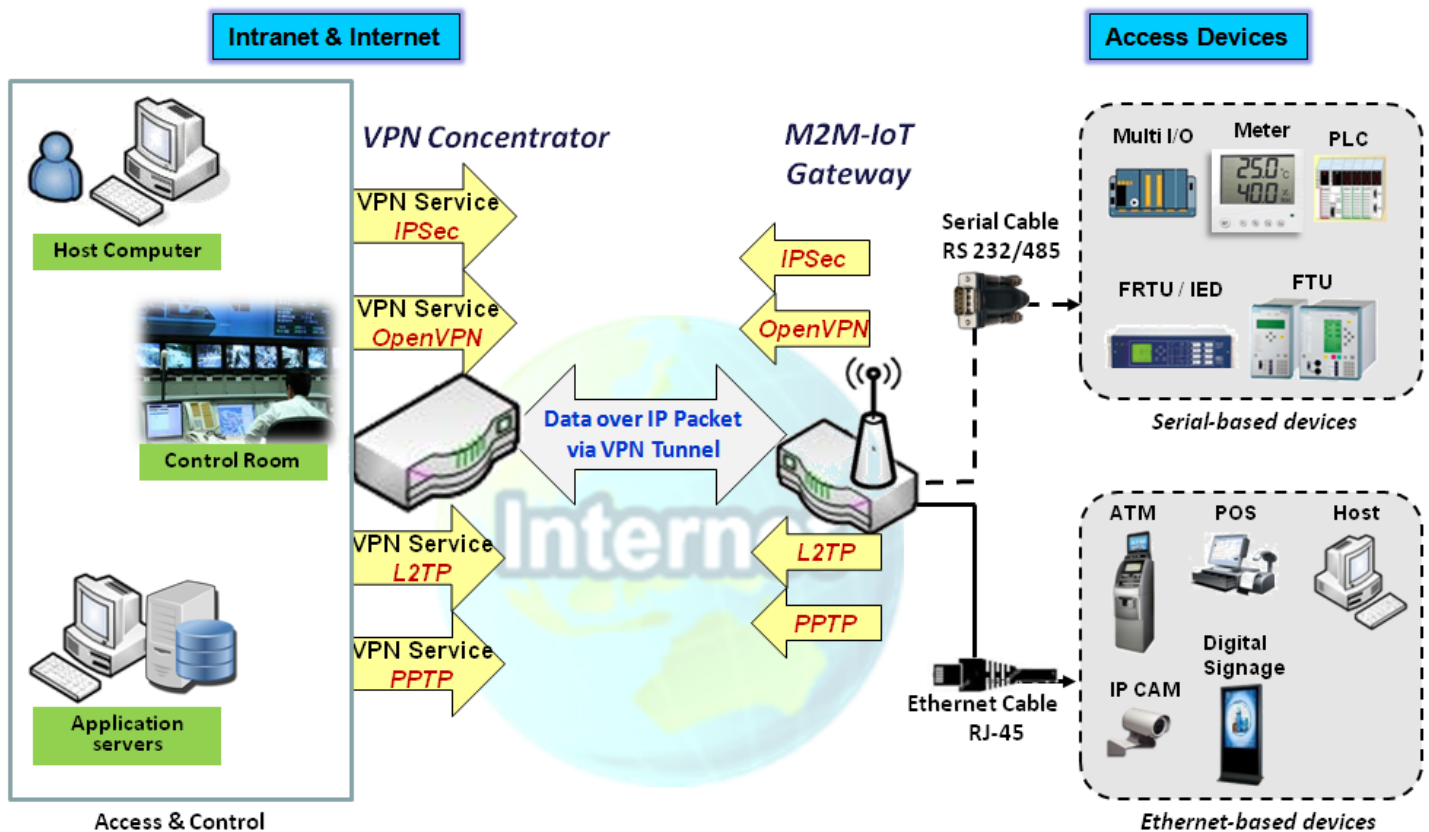

The product series supports different tunneling technologies to establish secure tunnels between multiple sites for data transferring, such as IPSec, OpenVPN, L2TP (over IPSec), PPTP and GRE. Besides, some advanced functions, like Full Tunnel, Tunnel Failover, Tunnel Load Balance, NetBIOS over IPSec, NAT Traversal and Dynamic VPN, are also supported.

# 4G IIoT Gateway

## 5.1.1 IPsec

Configuration [ Help ]	
Item	Setting
▶ IPsec	<input type="checkbox"/> Enable
▶ NetBIOS over IPsec	<input type="checkbox"/> Enable
▶ NAT Traversal	<input checked="" type="checkbox"/> Enable
▶ Max. Concurrent IPsec Tunnels	3

Dynamic VPN List [ Add ] [ Delete ] [ Refresh ]					
ID	Tunnel Name	Interface	Connected Client	Enable	Actions

  

IPsec Tunnel List [ Add ] [ Delete ] [ Refresh ]								
ID	Tunnel Name	Interface	Tunnel Scenario	Remote Gateway	Remote Subnet	Status	Enable	Actions

Internet Protocol Security (IPsec) is a protocol suite for securing Internet Protocol (IP) communications by authenticating and encrypting each IP packet of a communication session. IPsec includes protocols for establishing mutual authentication between agents at the beginning of the session and negotiation of cryptographic keys to be used during the session.

An IPsec VPN tunnel is established between IPsec client and server. Sometimes, we call the IPsec VPN client as the initiator and the IPsec VPN server as the responder. This gateway can be configured as different roles and establish number of tunnels with various remote devices. Before going to setup the VPN connections, you may need to decide the scenario type for the tunneling.

### IPsec Tunnel Scenarios

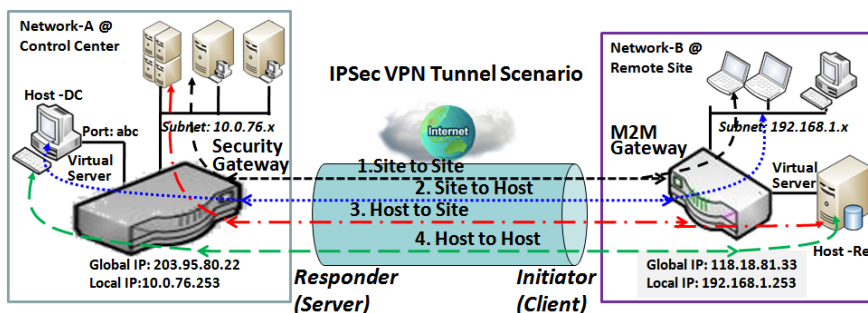

- ← - - - - -> Site to Site: Tunnel between M2M gateway /w 192.168.1.x subnet and UTM /w 10.0.76.x subnet
- ← - - - - -> Site to Host: Tunnel between M2M gateway /w 192.168.1.x subnet and Host-DC under UTM
- ← - - - - -> Host to Site: Tunnel between Host-Re under M2M Gateway and UTM /w 10.0.76.x subnet
- ← - - - - -> Host to Host: Tunnel between Host-Re under M2M Gateway and Host-DC under UTM

To build IPsec tunnel, you need to fill in remote gateway global IP, and optional subnet if the hosts behind IPsec peer can access to remote site or hosts. Under such configuration, there are four scenarios:

**Site to Site:** You need to setup remote gateway IP and subnet of both gateways. After the IPsec tunnel established, hosts behind both gateways can communication each other through the tunnel.

# 4G IIoT Gateway

**Site to Host:** Site to Host is suitable for tunneling between clients in a subnet and an application server (host). As in the diagram, the clients behind the M2M gateway can access to the host "Host-DC" located in the control center through Site to Host VPN tunnel.

**Host to Site:** On the contrast, for a single host (or mobile user to) to access the resources located in an intranet, the Host to Site scenario can be applied.

**Host to Host:** Host to Host is a special configuration for building a VPN tunnel between two single hosts.

## Site to Site with "Full Tunnel" enabled

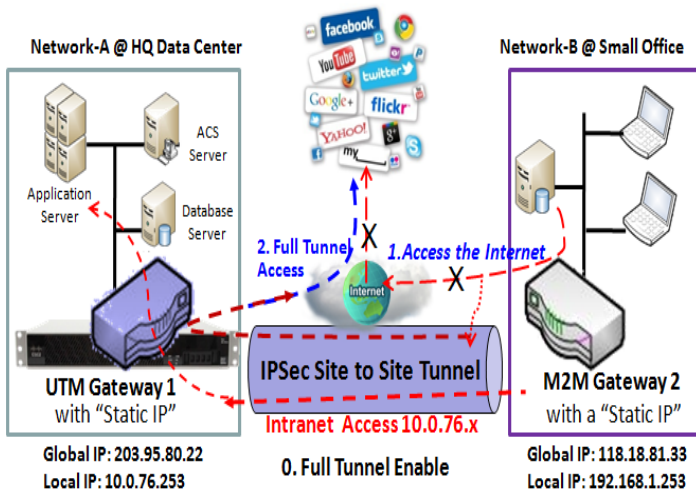

In "Site to Site" scenario, client hosts in remote site can access the enterprise resources in the Intranet of HQ gateway via an established IPSec tunnel, as described above. However, Internet access originates from remote site still go through its regular WAN connection. If you want all packets from remote site to be routed via this IPSec tunnel, including HQ server access and Internet access, you can just enable the "Full Tunnel" setting. As a result, every time users surfs web or searching data on Internet, checking personal emails, or HQ server access, all traffics will go through the secure IPSec tunnel and route by the Security Gateway in control center.

## Site to Site with "Hub and Spoke" mechanism

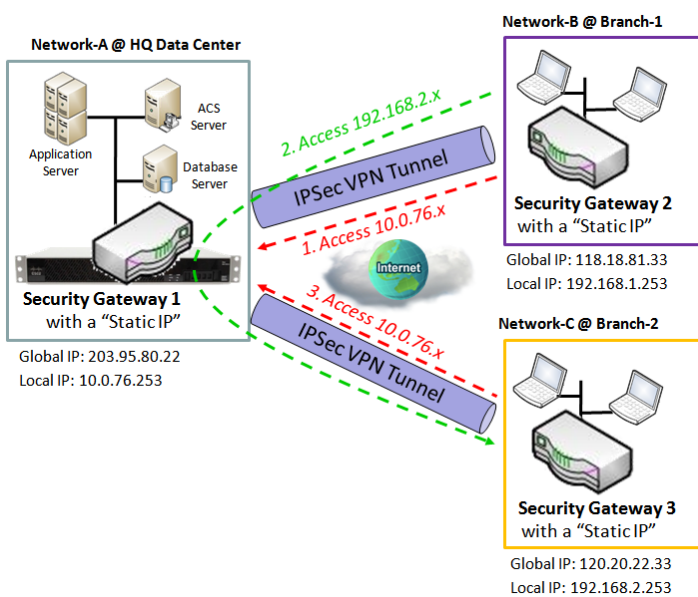

For a control center to manage the secure Intranet among all its remote sites, there is a simple configuration, called **Hub and Spoke**, for the whole VPN network. A Hub and Spoke VPN Network is set up in organizations with centralized control center over all its remote sites, like shops or offices. The control center acts as the Hub role and the remote shops or Offices act as Spokes. All VPN tunnels from remote sites terminate at this Hub, which acts as a concentrator. Site-to-site connections between spokes do not exist. Traffic originating from one spoke and destined for another spoke has to go via the Hub. Under such configuration, you don't need to maintain VPN tunnels between each two remote clients.

# 4G IIoT Gateway

## Dynamic VPN Server Scenario

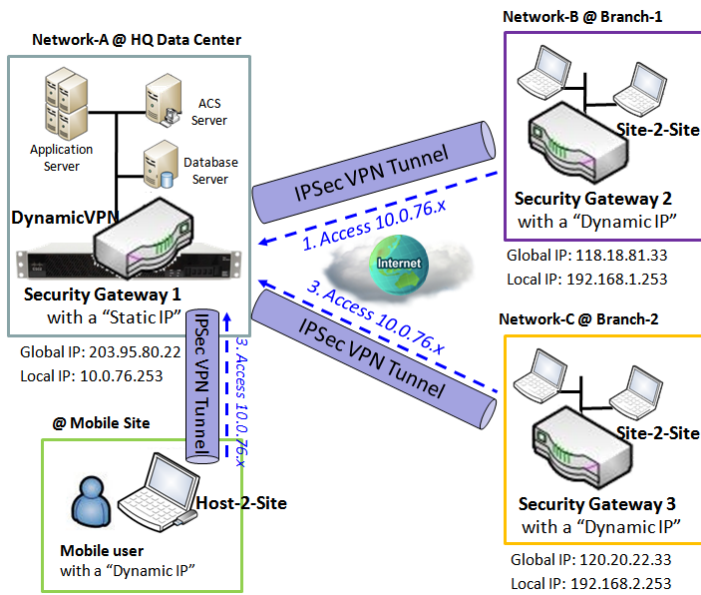

Dynamic VPN Server Scenario is an efficient way to build multiple tunnels with remote sites, especially for mobile clients with dynamic IP. In this scenario, gateway can only be role of server (responder), and it must have a "Static IP" or "FQDN". It can allow many VPN clients (initiators) to connect to with various tunnel scenarios. In short, with a simple Dynamic VPN server setting, many VPN clients can connect to the server. But, in comparison to the Hub and Spoke mechanism, it is not allowed to directly communicate between any two clients via the Dynamic VPN server.

For the purchased gateway, you can configure one Dynamic VPN server for each WAN interface.

# 4G IIoT Gateway

## IPSec Setting

Go to **Security > VPN > IPSec** tab.

The IPSec Setting allows user to create and configure IPSec tunnels.

### Enable IPSec

Configuration <span style="float: right;">[ Help ]</span>	
Item	Setting
▶ IPSec	<input type="checkbox"/> Enable
▶ NetBIOS over IPSec	<input type="checkbox"/> Enable
▶ NAT Traversal	<input checked="" type="checkbox"/> Enable
▶ Max. Concurrent IPSec Tunnels	3

Configuration Window		
Item	Value setting	Description
<b>IPsec</b>	Unchecked by default	Click the <b>Enable</b> box to enable IPSec function.
<b>NetBIOS over IPSec</b>	Unchecked by default	Click the <b>Enable</b> box to enable NetBIOS over IPSec function.
<b>NAT Traversal</b>	Checked by default	Click the <b>Enable</b> box to enable NAT Traversal function.
<b>Max. Concurrent IPSec Tunnels</b>	Depends on Product specification.	The specified value will limit the maximum number of simultaneous IPSec tunnel connection. The default value can be different for the purchased model.
<b>Save</b>	N/A	Click <b>Save</b> to save the settings
<b>Undo</b>	N/A	Click <b>Undo</b> to cancel the settings

### Create/Edit IPSec tunnel

Ensure that the IPSec enable box is checked to enable before further configuring the IPSec tunnel settings.

IPSec Tunnel List <span>Add</span> <span>Delete</span> <span>Refresh</span>								
ID	Tunnel Name	Interface	Tunnel Scenario	Remote Gateway	Remote Subnet	Status	Enable	Actions

When **Add/Edit** button is applied, a series of configuration screens will appear. They are Tunnel Configuration, Local & Remote Configuration, Authentication, IKE Phase, IKE Proposal Definition, IPSec Phase, and IPSec Proposal Definition. You have to configure the tunnel details for both local and remote VPN devices.

# 4G IIoT Gateway

Tunnel Configuration	
Item	Setting
▶ Tunnel	<input type="checkbox"/> Enable
▶ Tunnel Name	IPSec #1
▶ Interface	WAN1 ▼
▶ Tunnel Scenario	Site to Site ▼
▶ Tunnel TCP MSS	Auto ▼ 0 (64~1500 Bytes)
▶ Hub and Spoke	None ▼
▶ Operation Mode	Always on ▼
▶ Encapsulation Protocol	ESP ▼

Tunnel Configuration Window		
Item	Value setting	Description
<b>Tunnel</b>	Unchecked by default	Check the <b>Enable</b> box to activate the IPSec tunnel
<b>Tunnel Name</b>	1. A Must fill setting 2. String format can be any text	Enter a tunnel name. Enter a name that is easy for you to identify. <b>Value Range: 1 ~ 19 characters.</b>
<b>Interface</b>	1. A Must fill setting 2. <b>WAN 1</b> is selected by default	Select the interface on which IPSec tunnel is to be established. It can be the available WAN and LAN interfaces.
<b>Tunnel Scenario</b>	1. A Must fill setting 2. <b>Site to site</b> is selected by default	Select an IPSec tunneling scenario from the dropdown box for your application. Select <b>Site-to-Site</b> , <b>Site-to-Host</b> , <b>Host-to-Site</b> , or <b>Host-to-Host</b> . If LAN interface is selected, only <b>Host-to-Host</b> scenario is available.  With <b>Site-to-Site</b> or <b>Site-to-Host</b> or <b>Host-to-Site</b> , IPSec operates in tunnel mode. The difference among them is the number of subnets. With <b>Host-to-Host</b> , IPSec operates in transport mode.
<b>Tunnel TCP MSS</b>	1. An optional setting 2. <b>Auto</b> is set by default	Select from the dropdown box to define the size of Tunnel TCP MSS. Select <b>Auto</b> , and all devices will adjust this parameter automatically. Select <b>Manual</b> , and specify an expected value for Tunnel TCP MSS. <b>Value Range: 64 ~ 1500 bytes.</b>
<b>Hub and Spoke</b>	1. An optional setting 2. <b>None</b> is set by default	Select from the dropdown box to setup your gateway for Hub-and-Spoke IPSec VPN Deployments. Select <b>None</b> if your deployments will not support Hub or Spoke encryption. Select <b>Hub</b> for a Hub role in the IPSec design. Select <b>Spoke</b> for a Spoke role in the IPSec design. Note: Hub and Spoke are available only for Site-to-Site VPN tunneling specified in Tunnel Scenario. It is not available for Dynamic VPN tunneling application.
<b>Operation Mode</b>	1. A Must fill setting 2. <b>Always on</b> is selected	Define operation mode for the IPSec Tunnel. It can be <b>Always On</b> , or <b>Failover</b> . If this tunnel is set as a failover tunnel, you need to further select a primary

# 4G IIoT Gateway

	by default	tunnel from which to failover to. Note: <b>Failover</b> mode is not available for the gateway with single WAN.
<b>Encapsulation Protocol</b>	1. A Must fill setting 2. <b>ESP</b> is selected by default	Select the Encapsulation Protocol from the dropdown box for this IPsec tunnel. Available encapsulations are <b>ESP</b> and <b>AH</b> .

Local & Remote Configuration

Item	Setting												
<span style="font-size: 14px;">▶</span> Local Subnet List	<table border="1" style="width: 100%; border-collapse: collapse;"> <thead> <tr> <th style="width: 5%;">ID</th> <th style="width: 40%;">Subnet IP Address</th> <th style="width: 35%;">Subnet Mask</th> <th style="width: 20%;">Actions</th> </tr> </thead> <tbody> <tr> <td style="text-align: center;">1</td> <td><input style="width: 90%;" type="text" value="192.168.123.0"/></td> <td><input style="width: 90%;" type="text" value="255.255.255.0(/24)"/></td> <td style="text-align: center;"><input type="button" value="Delete"/></td> </tr> <tr> <td colspan="4" style="text-align: center;"><input type="button" value="Add"/></td> </tr> </tbody> </table>	ID	Subnet IP Address	Subnet Mask	Actions	1	<input style="width: 90%;" type="text" value="192.168.123.0"/>	<input style="width: 90%;" type="text" value="255.255.255.0(/24)"/>	<input type="button" value="Delete"/>	<input type="button" value="Add"/>			
ID	Subnet IP Address	Subnet Mask	Actions										
1	<input style="width: 90%;" type="text" value="192.168.123.0"/>	<input style="width: 90%;" type="text" value="255.255.255.0(/24)"/>	<input type="button" value="Delete"/>										
<input type="button" value="Add"/>													
<span style="font-size: 14px;">▶</span> Redirect Traffic	<input type="checkbox"/> Enable												
<span style="font-size: 14px;">▶</span> Full Tunnel	<input type="checkbox"/> Enable												
<span style="font-size: 14px;">▶</span> Remote Subnet List	<table border="1" style="width: 100%; border-collapse: collapse;"> <thead> <tr> <th style="width: 5%;">ID</th> <th style="width: 40%;">Subnet IP Address</th> <th style="width: 35%;">Subnet Mask</th> <th style="width: 20%;">Actions</th> </tr> </thead> <tbody> <tr> <td style="text-align: center;">1</td> <td><input style="width: 90%;" type="text"/></td> <td><input style="width: 90%;" type="text" value="255.255.255.0(/24)"/></td> <td style="text-align: center;"><input type="button" value="Delete"/></td> </tr> <tr> <td colspan="4" style="text-align: center;"><input type="button" value="Add"/></td> </tr> </tbody> </table>	ID	Subnet IP Address	Subnet Mask	Actions	1	<input style="width: 90%;" type="text"/>	<input style="width: 90%;" type="text" value="255.255.255.0(/24)"/>	<input type="button" value="Delete"/>	<input type="button" value="Add"/>			
ID	Subnet IP Address	Subnet Mask	Actions										
1	<input style="width: 90%;" type="text"/>	<input style="width: 90%;" type="text" value="255.255.255.0(/24)"/>	<input type="button" value="Delete"/>										
<input type="button" value="Add"/>													
<span style="font-size: 14px;">▶</span> Remote Gateway	<input style="width: 90%;" type="text"/> (IP Address/FQDN)												

Local & Remote Configuration Window	Item	Value setting	Description
	<b>Local Subnet List</b>	A Must fill setting	Specify the Local Subnet IP address and Subnet Mask. Click the Add or Delete button to add or delete a Local Subnet.  Note_1: When Dynamic VPN option in Tunnel Scenario is selected, there will be only one subnet available. Note_2: When Host-to-Site or Host-to-Host option in Tunnel Scenario is selected, Local Subnet will not be available. Note_3: When Hub and Spoke option in Hub and Spoke is selected, there will be only one subnet available.
	<b>Redirect Traffic</b>	Unchecked by default	Click <b>Enable</b> box to activate the Redirect Traffic function.  Note: Redirect Traffic is available only for Host-to-Site specified in Tunnel Scenario. By default, it is disabled, so it can prevent the un-expected and dangerous access to the peer subnet. If you enable such function, all the network devices behind the VPN host (actually, it is an NAT gateway) can access to the peer subnet with the host IP.
	<b>Full Tunnel</b>	Unchecked by default	Click <b>Enable</b> box to enable Full Tunnel. Note: Full tunnel is available only for Site-to-Site specified in Tunnel Scenario.

# 4G IIoT Gateway

<b>Remote Subnet List</b>	A Must fill setting	Specify the Remote Subnet IP address and Subnet Mask. Click the Add or Delete button to add or delete Remote Subnet setting.
<b>Remote Gateway</b>	1. A Must fill setting. 2. Format can be a ipv4 address or FQDN	Specify the Remote Gateway.

☐ Authentication

Item	Setting
▶ Key Management	<div style="display: flex; align-items: center;"> <div style="border: 1px solid #ccc; padding: 2px 5px; margin-right: 5px;">IKE+Pre-shared Key ▼</div> <input style="width: 60%; border: 1px solid #ccc;" type="text"/> <span style="color: red; font-weight: bold; margin-left: 10px;">(Min. 8 characters)</span> </div>
▶ Local ID	Type: <div style="border: 1px solid #ccc; padding: 2px 5px; display: inline-block;">User Name ▼</div> ID: <input style="width: 60%; border: 1px solid #ccc;" type="text"/> (Optional)
▶ Remote ID	Type: <div style="border: 1px solid #ccc; padding: 2px 5px; display: inline-block;">User Name ▼</div> ID: <input style="width: 60%; border: 1px solid #ccc;" type="text"/>

Authentication Configuration Window		
Item	Value setting	Description
<b>Key Management</b>	1. A Must fill setting 2. Pre-shared Key 8 to 32 characters.	Select Key Management from the dropdown box for this IPsec tunnel. <b>IKE+Pre-shared Key:</b> user needs to set a key (8 ~ 32 characters). <b>IKE+X.509:</b> user needs Certificate to authenticate. IKE+X.509 will be available only when Certificate has been configured properly. Refer to Certificate section of this manual and also <b>Object Definition &gt; Certificate</b> in web-based utility. <b>Manually:</b> user needs to enter key ID to authenticate. Manual key configuration will be explained in the following Manual Key Management section.
<b>Local ID</b>	An optional setting	Specify the Local ID for this IPsec tunnel to authenticate. Select <b>User Name</b> for Local ID and enter the username. The username may include but can't be all numbers. Select <b>FQDN</b> for Local ID and enter the FQDN. Select <b>User@FQDN</b> for Local ID and enter the User@FQDN. Select <b>Key ID</b> for Local ID and enter the Key ID (English alphabet or number).
<b>Remote ID</b>	An optional setting	Specify the Remote ID for this IPsec tunnel to authenticate. Select <b>User Name</b> for Remote ID and enter the username. The username may include but can't be all numbers. Select <b>FQDN</b> for Local ID and enter the FQDN. Select <b>User@FQDN</b> for Remote ID and enter the User@FQDN. Select <b>Key ID</b> for Remote ID and enter the Key ID (English alphabet or number). Note: Remote ID will be not available when Dynamic VPN option in Tunnel Scenario is selected.

# 4G IIoT Gateway

IKE Phase	
Item	Setting
▶ IKE Version	v1 ▾
▶ Negotiation Mode	Main Mode ▾
▶ X-Auth	None ▾ X-Auth Account (Optional) User Name : <input type="text"/> Password : <input type="text"/>
▶ Dead Peer Detection (DPD)	<input checked="" type="checkbox"/> Enable Timeout : <input type="text" value="180"/> (seconds) Delay : <input type="text" value="30"/> (seconds)
▶ Phase1 Key Life Time	<input type="text" value="3600"/> (seconds) (Max. 86400)

IKE Phase Window		
Item	Value setting	Description
<b>IKE Version</b>	1. A must fill setting 2. v1 is selected by default	Specify the IKE version for this IPsec tunnel. Select v1 or v2 Note: IKE versions will not be available when Dynamic VPN option in Tunnel Scenario is selected, or AH option in Encapsulation Protocol is selected.
<b>Negotiation Mode</b>	Main Mode is set by default default	Specify the Negotiation Mode for this IPsec tunnel. Select Main Mode or Aggressive Mode.
<b>X-Auth</b>	None is selected by default	Specify the X-Auth role for this IPsec tunnel. Select Server, Client, or None. Selected None no X-Auth authentication is required. Selected Server this gateway will be an X-Auth server. Click on the X-Auth Account button to create remote X-Auth client account. Selected Client this gateway will be an X-Auth client. Enter User name and Password to be authenticated by the X-Auth server gateway. Note: X-Auth Client will not be available for Dynamic VPN option selected in Tunnel Scenario.
<b>Dead Peer Detection (DPD)</b>	1. Checked by default 2. Default Timeout 180s and Delay 30s	Click <b>Enable</b> box to enable <b>DPD</b> function. Specify the <b>Timeout</b> and <b>Delay</b> time in seconds. <b>Value Range: 0 ~ 999 seconds for Timeout and Delay.</b>
<b>Phase1 Key Life Time</b>	1. A Must fill setting 2. Default 3600s 3. Max. 86400s	Specify the Phase1 Key Life Time. <b>Value Range: 30 ~ 86400.</b>

# 4G IIoT Gateway

IKE Proposal Definition				
ID	Encryption	Authentication	DH Group	Definition
1	AES-auto ▼	SHA1 ▼	Group 2 ▼	<input checked="" type="checkbox"/> Enable
2	AES-auto ▼	MD5 ▼	Group 2 ▼	<input checked="" type="checkbox"/> Enable
3	DES ▼	SHA1 ▼	Group 2 ▼	<input checked="" type="checkbox"/> Enable
4	3DES ▼	SHA1 ▼	Group 2 ▼	<input checked="" type="checkbox"/> Enable

IKE Proposal Definition Window		
Item	Value setting	Description
IKE Proposal Definition	A Must fill setting	Specify the Phase 1 Encryption method. It can be DES / 3DES / AES-auto / AES-128 / AES-192 / AES-256.
		Specify the Authentication method. It can be None / MD5 / SHA1 / SHA2-256.
		Specify the DH Group. It can be None / Group1 / Group2 / Group5 / Group14 / Group15 / Group16 / Group17 / Group18.
		Check <b>Enable</b> box to enable this setting

IPSec Phase	
Item	Setting
▶ Phase2 Key Life Time	28800 (seconds) (Max. 86400)

IPSec Phase Window		
Item	Value setting	Description
Phase2 Key Life Time	<ol style="list-style-type: none"> <li>1. A Must fill setting</li> <li>2. 28800s is set by default</li> <li>3. Max. 86400s</li> </ol>	Specify the Phase2 Key Life Time in second. <b><i>Value Range: 30 ~ 86400.</i></b>

# 4G IIoT Gateway

IPSec Proposal Definition				
ID	Encryption	Authentication	PFS Group	Definition
1	AES-auto ▼	SHA1 ▼	Group 2 ▼	<input checked="" type="checkbox"/> Enable
2	AES-auto ▼	MD5 ▼		<input checked="" type="checkbox"/> Enable
3	DES ▼	SHA1 ▼		<input checked="" type="checkbox"/> Enable
4	3DES ▼	SHA1 ▼		<input checked="" type="checkbox"/> Enable

IPSec Proposal Definition Window		
Item	Value setting	Description
IPSec Proposal Definition	A Must fill setting	<p>Specify the Encryption method. It can be None / DES / 3DES / AES-auto / AES-128 / AES-192 / AES-256. Note: None is available only when Encapsulation Protocol is set as <b>AH</b>; it is not available for <b>ESP</b> Encapsulation.</p> <p>Specify the Authentication method. It can be None / MD5 / SHA1 / SHA2-256. Note: None and SHA2-256 are available only when Encapsulation Protocol is set as <b>ESP</b>; they are not available for <b>AH</b> Encapsulation.</p> <p>Specify the PFS Group. It can be None / Group1 / Group2 / Group5 / Group14 / Group15 / Group16 / Group17 / Group18.</p> <p>Click <b>Enable</b> to enable this setting</p>
Save	N/A	Click <b>Save</b> to save the settings
Undo	N/A	Click <b>Undo</b> to cancel the settings
Back	N/A	Click <b>Back</b> to return to the previous page.

## Manual Key Management

When the Manually option is selected for Key Management as described in Authentication Configuration Window, a series of configuration windows for Manual IPSec Tunnel configuration will appear. The configuration windows are the Local & Remote Configuration, the Authentication, and the Manual Proposal.

Authentication	
Item	Setting
▶ Key Management	Manually ▼
▶ Local ID	Type: KEY ID ▼ ID: <input type="text"/> (Optional)
▶ Remote ID	Type: KEY ID ▼ ID: <input type="text"/>

Authentication Window		
Item	Value setting	Description

# 4G IIoT Gateway

<b>Key Management</b>	A Must fill setting	Select Key Management from the dropdown box for this IPSec tunnel. In this section <b>Manually</b> is the option selected.
<b>Local ID</b>	An optional setting	Specify the <b>Local ID</b> for this IPSec tunnel to authenticate. Select the <b>Key ID</b> for Local ID and enter the Key ID (English alphabet or number).
<b>Remote ID</b>	An optional setting	Specify the <b>Remote ID</b> for this IPSec tunnel to authenticate. Select <b>Key ID</b> for Remote ID and enter the Key ID (English alphabet or number).

Local & Remote Configuration	
Item	Setting
▶ Local Subnet	<input type="text"/>
▶ Local Netmask	<input type="text" value="255.255.255.0"/>
▶ Remote Subnet	<input type="text"/>
▶ Remote Netmask	<input type="text"/>
▶ Remote Gateway	<input type="text"/> (IP Address/FQDN)

Local & Remote Configuration Window		
Item	Value setting	Description
<b>Local Subnet</b>	A Must fill setting	Specify the Local Subnet IP address and Subnet Mask.
<b>Local Netmask</b>	A Must fill setting	Specify the Local Subnet Mask.
<b>Remote Subnet</b>	A Must fill setting	Specify the Remote Subnet IP address
<b>Remote Netmask</b>	A Must fill setting	Specify the Remote Subnet Mask.
<b>Remote Gateway</b>	1. A Must fill setting 2. An IPv4 address or FQDN format	Specify the Remote Gateway. The Remote Gateway

Under the Manually Key Management authentication configuration, only one subnet is supported for both Local and Remote IPSec peer.

Manual Proposal	
Item	Setting
▶ Outbound SPI	0x <input type="text"/>
▶ Inbound SPI	0x <input type="text"/>
▶ Encryption	DES <input type="text"/>
▶ Authentication	None <input type="text"/>

Manual Proposal Window		
Item	Value setting	Description
<b>Outbound SPI</b>	Hexadecimal format	Specify the Outbound SPI for this IPSec tunnel.

# 4G IIoT Gateway

		<i>Value Range: 0 ~ FFFF.</i>
<b>Inbound SPI</b>	Hexadecimal format	Specify the Inbound SPI for this IPsec tunnel. <i>Value Range: 0 ~ FFFF.</i>
<b>Encryption</b>	1. A Must fill setting 2. Hexadecimal format	Specify the Encryption Method and Encryption key. Available encryption methods are DES/3DES/AES-128/AES-192/AES-256. The key length for DES is 16, 3DES is 48, AES-128 is 32, AES-192 is 48, and AES-256 is 64. Note: When <b>AH</b> option in Encapsulation is selected, encryption will not be available.
<b>Authentication</b>	1. A Must fill setting 2. Hexadecimal format	Specify the Authentication Method and Authentication key. Available encryptions are None/MD5/SHA1/SHA2-256. The key length for MD5 is 32, SHA1 is 40, and SHA2-256 is 64. Note: When <b>AH</b> option in Encapsulation Protocol is selected, None option in Authentication will not be available.
<b>Save</b>	N/A	Click <b>Save</b> to save the settings
<b>Undo</b>	N/A	Click <b>Undo</b> to cancel the settings
<b>Back</b>	N/A	Click <b>Back</b> to return to the previous page.

## Create/Edit Dynamic VPN Server List

Dynamic server List <input type="button" value="Add"/> <input type="button" value="Delete"/>					
ID	Tunnel Name	Interface	Connected Client	Enable	Actions

Similar to create an IPsec VPN Tunnel for site/host to site/host scenario, when **Edit** button is applied a series of configuration screen will appear. They are Tunnel Configuration, Local & Remote Configuration, Authentication, IKE Phase, IKE Proposal Definition, IPsec Phase, and IPsec Proposal Definition. You have to configure the tunnel details for the gateway as a Dynamic VPN server.

Note: For the purchased gateway, you can configure one Dynamic VPN server for each WAN interface.

Tunnel Configuration	
Item	Setting
▶ Tunnel	<input type="checkbox"/> Enable
▶ Tunnel Name	<input type="text" value="Dynamic IPsec1"/>
▶ Interface	<input type="text" value="WAN1"/> ▼
▶ Tunnel Scenario	<input type="text" value="Dynamic VPN"/> ▼
▶ Operation Mode	<input type="text" value="Always on"/> ▼
▶ Encapsulation Protocol	<input type="text" value="ESP"/> ▼

# 4G IIoT Gateway

Tunnel Configuration Window		
Item	Value setting	Description
<b>Tunnel</b>	Unchecked by default	Check the <b>Enable</b> box to activate the Dynamic IPsec VPN tunnel.
<b>Tunnel Name</b>	1. A Must fill setting 2. String format can be any text	Enter a tunnel name. Enter a name that is easy for you to identify. <b>Value Range: 1 ~ 19 characters.</b>
<b>Interface</b>	1. A Must fill setting 2. <b>WAN 1</b> is selected by default	Select WAN interface on which IPsec tunnel is to be established.
<b>Tunnel Scenario</b>	1. A Must fill setting 2. Dynamic VPN is selected by default	The IPsec tunneling scenario is fixed to Dynamic VPN.
<b>Operation Mode</b>	1. A Must fill setting 2. <b>Always on</b> is selected by default	The available operation mode is <b>Always On</b> . Failover option is not available for the Dynamic IPsec scenario.
<b>Encapsulation Protocol</b>	1. A Must fill setting 2. <b>ESP</b> is selected by default	Select the Encapsulation Protocol from the dropdown box for this IPsec tunnel. Available encapsulations are <b>ESP</b> and <b>AH</b> .

Local & Remote Configuration	
Item	Setting
▶ Local Subnet	<input type="text"/>
▶ Local Netmask	<input type="text"/>

Local & Remote Configuration Window		
Item	Value setting	Description
<b>Local Subnet</b>	A Must fill setting	Specify the Local Subnet IP address.
<b>Local Netmask</b>	A Must fill setting	Specify the Local Subnet Mask.

Authentication	
Item	Setting
▶ Key Management	IKE+Pre-shared Key ▼ <input type="text"/> (Min. 8 characters)
▶ Local ID	Type: User Name ▼ ID: <input type="text"/> (Optional)
▶ Remote ID	Type: User Name ▼ ID: <input type="text"/>

Authentication Configuration Window		
Item	Value setting	Description
<b>Key Management</b>	1. A Must fill setting	Select Key Management from the dropdown box for this IPsec tunnel.

## 4G IIoT Gateway

	2. Pre-shared Key 8 to 32 characters.	<b>IKE+Pre-shared Key</b> : user needs to set a key (8 ~ 32 characters).
<b>Local ID</b>	An optional setting	Specify the Local ID for this IPsec tunnel to authenticate. Select <b>User Name</b> for Local ID and enter the username. The username may include but can't be all numbers. Select <b>FQDN</b> for Local ID and enter the FQDN. Select <b>User@FQDN</b> for Local ID and enter the User@FQDN. Select <b>Key ID</b> for Local ID and enter the Key ID (English alphabet or number).
<b>Remote ID</b>	An optional setting	Specify the Remote ID for this IPsec tunnel to authenticate. Select <b>User Name</b> for Remote ID and enter the username. The username may include but can't be all numbers. Select <b>FQDN</b> for Local ID and enter the FQDN. Select <b>User@FQDN</b> for Remote ID and enter the User@FQDN. Select <b>Key ID</b> for Remote ID and enter the Key ID (English alphabet or number). Note: Remote ID will be not available when Dynamic VPN option in Tunnel Scenario is selected.

For the rest IKE Phase, IKE Proposal Definition, IPsec Phase, and IPsec Proposal Definition settings, they are the same as that of creating an IPsec Tunnel described in previous section. Please refer to the related description.

# 4G IIoT Gateway

## 5.1.2 OpenVPN

OpenVPN is an application that implements virtual private network (VPN) techniques for creating secure point-to-point or site-to-site connections in routed or bridged configurations and remote access facilities. It uses a custom security protocol that utilizes SSL/TLS for key exchange. It is capable of traversing network address translators (NATs) and firewalls.

OpenVPN allows peers to authenticate each other using a Static Key (pre-shared key) or certificates. When used in a multi-client-server configuration, it allows the server to release an authentication certificate for every client, using signature and certificate authority. It uses the OpenSSL encryption library extensively, as well as the SSLv3/TLSv1 protocol, and contains many security and control features.

OpenVPN Tunneling is a Client and Server based tunneling technology. The OpenVPN Server must have a Static IP or a FQDN, and maintain a Client list. The OpenVPN Client may be a mobile user or mobile site with public IP or private IP, and requesting the OpenVPN tunnel connection. The product supports both OpenVPN Server and OpenVPN Client features to meet different application requirements.

There are two OpenVPN connection scenarios. They are the TAP and TUN scenarios. The product can create either a layer-3 based IP tunnel (TUN), or a layer-2 based Ethernet TAP that can carry any type of Ethernet traffic. In addition to configuring the device as a Server or Client, you have to specify which type of OpenVPN connection scenario is to be adopted.

### OpenVPN TUN Scenario

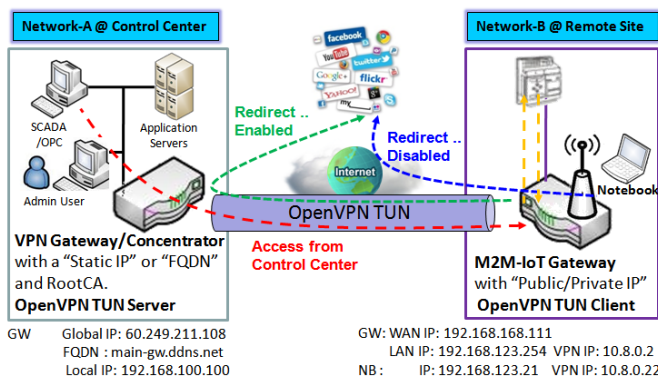

1. M2M-IoT Gateway (as OpenVPN TUN Client) connects to peer VPN Gateway/Concentrator (as OpenVPN TUN Server).
2. M2M-IoT Gateway will be assigned 10.8.0.2 IP Address after OpenVPN TUN Connection established. (10.8.0.x is a virtual subnet)
3. Local networked device will get a virtual IP 10.8.0.x if its traffic goes through the OpenVPN TUN connection (when NAT disabled & Redirect Internet Traffic enabled).
4. SCADA Server in Control Center can access remote attached device(s) with the assigned IP Address 10.8.0.2.

solution.

As shown in the diagram, the M2M-IoT Gateway is configured as an OpenVPN TUN Client, and connects to an OpenVPN TUN Server. Once the OpenVPN TUN connection is established, the connected TUN client will be

The term "TUN" mode is referred to routing mode and operates with layer 3 packets. In routing mode, the VPN client is given an IP address on a different subnet than the local LAN under the OpenVPN server. This virtual subnet is created for connecting to any remote VPN computers. In routing mode, the OpenVPN server creates a "TUN" interface with its own IP address pool which is different to the local LAN. Remote hosts that dial-in will get an IP address inside the virtual network and will have access only to the server where OpenVPN resides.

If you want to offer remote access to a VPN server from client(s), and inhibit the access to remote LAN resources under VPN server, OpenVPN TUN mode is the simplest

# 4G IIoT Gateway

assigned a virtual IP (10.8.0.2) which is belong to a virtual subnet that is different to the local subnet in Control Center. With such connection, the local networked devices will get a virtual IP 10.8.0.x if its traffic goes through the OpenVPN TUN connection when Redirect Internet Traffic settings is enabled; Besides, the SCADA Server in Control Center can access remote attached serial device(s) with the virtual IP address (10.8.0.2).

## OpenVPN TAP Scenario

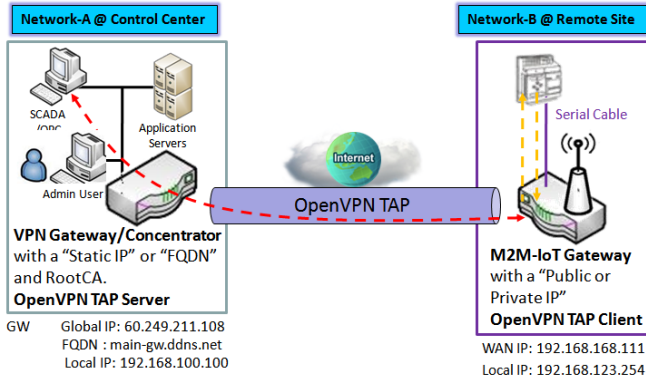

1. M2M-IoT Gateway (as OpenVPN TAP Client) connects to peer VPN Gateway/Concentrator (as OpenVPN TAP Server).
2. M2M-IoT Gateway will be assigned **192.168.100.210** IP Address after OpenVPN TAP Connection established. (**same subnet as in Control Center**)
3. SCADA Server in Control Center can access remote attached device(s) with the assigned IP Address 192.168.100.210.

The term "TAP" is referred to bridge mode and operates with layer 2 packets. In bridge mode, the VPN client is given an IP address on the same subnet as the LAN resided under the OpenVPN server. Under such configuration, the OpenVPN client can directly access to the resources in LAN. If you want to offer remote access to the entire remote LAN for VPN client(s), you have to setup OpenVPN in "TAP" bridge mode.

As shown in the diagram, the M2M-IoT Gateway is configured as an OpenVPN TAP Client, and connects to an OpenVPN TAP Server. Once the OpenVPN TAP connection is established, the connected TAP client will be assigned a virtual IP (192.168.100.210) which is the same subnet as

that of local subnet in Control Center. With such connection, the SCADA Server in Control Center can access remote attached serial device(s) with the virtual IP address (192.168.100.210).

# 4G IIoT Gateway

## Open VPN Setting

Go to **Security > VPN > OpenVPN** tab.

The OpenVPN setting allows user to create and configure OpenVPN tunnels.

### Enable OpenVPN

Enable OpenVPN and select an expected configuration, either server or client, for the gateway to operate.

Configuration	
Item	Setting
▶ OpenVPN	<input type="checkbox"/> Enable
▶ Server / Client	Server ▼

Configuration		
Item	Value setting	Description
<b>OpenVPN</b>	The box is unchecked by default	Check the <b>Enable</b> box to activate the OpenVPN function.
<b>Server/Client</b>	Server Configuration is selected by default.	When <b>Server</b> is selected, as the name indicated, server configuration will be displayed below for further setup. When <b>Client</b> is selected, you can specify the client settings in another client configuration window.

# 4G IIoT Gateway

## As an OpenVPN Server

If **Server** is selected, an OpenVPN Server Configuration screen will appear. **OpenVPN Server Configuration** window can let you enable the OpenVPN server function, specify the virtual IP address of OpenVPN server, when remote OpenVPN clients dial in, and the authentication protocol.

The OpenVPN Server supports up to 4 TUN / TAP tunnels at the same time.

OpenVPN Server Configuration	
Item	Setting
▶ OpenVPN Server	<input checked="" type="checkbox"/> Enable
▶ Protocol	TCP ▼
▶ Port	4430
▶ Tunnel Scenario	TUN ▼
▶ Authorization Mode	Static Key ▼
▶ Local Endpoint IP Address	
▶ Remote Endpoint IP Address	
▶ Static Key	
▶ Server Virtual IP	10.8.0.0
▶ DHCP-Proxy Mode	<input checked="" type="checkbox"/> Enable
▶ IP Pool	Starting Address: <input type="text"/> ~ Ending Address: <input type="text"/>
▶ Gateway	<input type="text"/>
▶ Netmask	255.255.255.0(/24) ▼
▶ Redirect Default Gateway	<input type="checkbox"/> Enable
▶ Encryption Cipher	Blowfish ▼
▶ Hash Algorithm	SHA-1 ▼
▶ LZO Compression	Adaptive ▼
▶ Persist Key	<input checked="" type="checkbox"/> Enable
▶ Persist Tun	<input checked="" type="checkbox"/> Enable
▶ Advanced Configuration	Edit

# 4G IIoT Gateway

OpenVPN Server Configuration		
Item	Value setting	Description
<b>OpenVPN Server</b>	The box is unchecked by default.	Click the <b>Enable</b> to activate OpenVPN Server functions.
<b>Protocol</b>	<ol style="list-style-type: none"> <li>1. A Must filled setting</li> <li>2. By default <b>TCP</b> is selected.</li> </ol>	Define the selected <b>Protocol</b> for connecting to the OpenVPN Server. <ul style="list-style-type: none"> <li>• Select <b>TCP , or UDP</b> -&gt; The TCP protocol will be used to access the OpenVPN Server, and <b>Port</b> will be set as 4430 automatically.</li> <li>• Select <b>UDP</b> -&gt; The UDP protocol will be used to access the OpenVPN Server, and <b>Port</b> will be set as 1194 automatically.</li> </ul>
<b>Port</b>	<ol style="list-style-type: none"> <li>1. A Must filled setting</li> <li>2. By default <b>4430</b> is set.</li> </ol>	Specify the <b>Port</b> for connecting to the OpenVPN Server. <b>Value Range: 1 ~ 65535.</b>
<b>Tunnel Scenario</b>	<ol style="list-style-type: none"> <li>1. A Must filled setting</li> <li>2. By default <b>TUN</b> is selected.</li> </ol>	Specify the type of <b>Tunnel Scenario</b> for connecting to the OpenVPN Server. It can be <b>TUN</b> for TUN tunnel scenario, or <b>TAP</b> for TAP tunnel scenario.
<b>Authorization Mode</b>	<ol style="list-style-type: none"> <li>1. A Must filled setting</li> <li>2. By default <b>Static Key</b> is selected.</li> </ol>	Specify the authorization mode for the OpenVPN Server. <ul style="list-style-type: none"> <li>• <b>TLS</b> -&gt;The OpenVPN will use TLS authorization mode, and the following items <b>CA Cert.</b>, <b>Server Cert.</b> and <b>DH PEM</b> will be displayed. <b>CA Cert.</b> could be generated in Certificate. Refer to <b>Object Definition &gt; Certificate &gt; Trusted Certificate.</b> <b>Server Cert.</b> could be generated in Certificate. Refer to <b>Object Definition &gt; Certificate &gt; My Certificate.</b></li> <li>• <b>Static Key</b> -&gt;The OpenVPN will use static key (pre-shared) authorization mode, and the following items <b>Local Endpoint IP Address</b>, <b>Remote Endpoint IP Address</b> and <b>Static Key</b> will be displayed. Note: Static Key will be available only when TUN is chosen in Tunnel Scenario.</li> </ul>
<b>Local Endpoint IP Address</b>	A Must filled setting	Specify the virtual <b>Local Endpoint IP Address</b> of this OpenVPN gateway. <b>Value Range: The IP format is 10.8.0.x, the range of x is 1~254.</b> Note: Local Endpoint IP Address will be available only when Static Key is chosen in Authorization Mode.
<b>Remote Endpoint IP Address</b>	A Must filled setting	Specify the virtual <b>Remote Endpoint IP Address</b> of the peer OpenVPN gateway. <b>Value Range: The IP format is 10.8.0.x, the range of x is 1~254.</b> Note: Remote Endpoint IP Address will be available only when Static Key is chosen in Authorization Mode.
<b>Static Key</b>	A Must filled setting	Specify the <b>Static Key</b> . Note: Static Key will be available only when Static Key is chosen in Authorization Mode.
<b>Server Virtual IP</b>	A Must filled setting	Specify the <b>Server Virtual IP</b> . <b>Value Range: The IP format is 10.y.0.0, the range of y is 1~254.</b> Note: Server Virtual IP will be available only when TLS is chosen in Authorization Mode.
<b>DHCP-Proxy Mode</b>	<ol style="list-style-type: none"> <li>1. A Must filled setting</li> <li>2. The box is checked by default.</li> </ol>	Check the <b>Enable</b> box to activate the <b>DHCP-Proxy Mode</b> . Note: DHCP-Proxy Mode will be available only when TAP is chosen in Tunnel Device.
<b>IP Pool</b>	A Must filled setting	Specify the virtual <b>IP pool</b> setting for the OpenVPN server. You have to specify the <b>Starting Address</b> and <b>Ending Address</b> as the IP address pool for the OpenVPN clients. Note: IP Pool will be available only when TAP is chosen in Tunnel Device, and

## 4G IIoT Gateway

		DHCP-Proxy Mode is unchecked (disabled).
<b>Gateway</b>	A Must filled setting	Specify the <b>Gateway</b> setting for the OpenVPN server. It will be assigned to the connected OpenVPN clients. Note: Gateway will be available only when TAP is chosen in Tunnel Device, and DHCP-Proxy Mode is unchecked (disabled).
<b>Netmask</b>	By default - <b>select one</b> - is selected.	Specify the <b>Netmask</b> setting for the OpenVPN server. It will be assigned to the connected OpenVPN clients. <b><i>Value Range: 255.255.255.0/24 (only support class C)</i></b> Note_1: Netmask will be available when TAP is chosen in Tunnel Device, and DHCP-Proxy Mode is unchecked (disabled). Note_2: Netmask will also be available when TUN is chosen in Tunnel Device.
<b>Redirect Default Gateway</b>	1. An Optional setting. 2. The box is unchecked by default.	Check the <b>Enable</b> box to activate the <b>Redirect Default Gateway</b> function.
<b>Encryption Cipher</b>	1. A Must filled setting. 2. By default <b>Blowfish</b> is selected.	Specify the <b>Encryption Cipher</b> from the dropdown list. It can be <b>Blowfish/AES-256/AES-192/AES-128/None</b> .
<b>Hash Algorithm</b>	By default <b>SHA-1</b> is selected.	Specify the <b>Hash Algorithm</b> from the dropdown list. It can be <b>SHA-1/MD5/MD4/SHA2-256/SHA2-512/None/Disable</b> .
<b>LZO Compression</b>	By default <b>Adaptive</b> is selected.	Specify the <b>LZO Compression</b> scheme. It can be <b>Adaptive/YES/NO/Default</b> .
<b>Persis Key</b>	1. An Optional setting. 2. The box is checked by default.	Check the <b>Enable</b> box to activate the <b>Persis Key</b> function.
<b>Persis Tun</b>	1. An Optional setting. 2. The box is checked by default.	Check the <b>Enable</b> box to activate the <b>Persis Tun</b> function.
<b>Advanced Configuration</b>	N/A	Click the <b>Edit</b> button to specify the <b>Advanced Configuration</b> setting for the OpenVPN server. If the button is clicked, <b>Advanced Configuration</b> will be displayed below.
<b>Save</b>	N/A	Click <b>Save</b> to save the settings.
<b>Undo</b>	N/A	Click <b>Undo</b> to cancel the changes.

# 4G IIoT Gateway

When **Advanced Configuration** is selected, an OpenVPN Server Advanced Configuration screen will appear.

OpenVPN Server Advanced Configuration	
Item	Setting
▶ TLS Cipher	TLS-RSA-WITH-AES128-SHA ▼
▶ TLS Auth. Key	<input type="text"/> (Optional)
▶ Client to Client	<input checked="" type="checkbox"/> Enable
▶ Duplicate CN	<input checked="" type="checkbox"/> Enable
▶ Tunnel MTU	1500
▶ Tunnel UDP Fragment	1500
▶ Tunnel UDP MSS-Fix	<input type="checkbox"/> Enable
▶ CCD-Dir Default File	<input type="text"/>
▶ Client Connection Script	<input type="text"/>
▶ Additional Configuration	<input type="text"/>

OpenVPN Server Advanced Configuration		
Item	Value setting	Description
<b>TLS Cipher</b>	1. A Must filled setting. 2. <b>TLS-RSA-WITH-AES128-SHA</b> is selected by default	Specify the <b>TLS Cipher</b> from the dropdown list. It can be <b>None / TLS-RSA-WITH-RC4-MD5 / TLS-RSA-WITH-AES128-SHA / TLS-RSA-WITH-AES256-SHA / TLS-DHE-DSS-AES128-SHA / TLS-DHE-DSS-AES256-SHA</b> . Note: TLS Cipher will be available only when TLS is chosen in Authorization Mode.
<b>TLS Auth. Key</b>	1. An Optional setting. 2. String format: any text	Specify the <b>TLS Auth. Key</b> . Note: TLS Auth. Key will be available only when TLS is chosen in Authorization Mode.
<b>Client to Client</b>	The box is checked by default	Check the <b>Enable</b> box to enable the traffics among different OpenVPN Clients. Note: Client to Client will be available only when TLS is chosen in Authorization Mode
<b>Duplicate CN</b>	The box is checked by default	Check the <b>Enable</b> box to activate the <b>Duplicate CN</b> function. Note: Duplicate CN will be available only when TLS is chosen in Authorization Mode
<b>Tunnel MTU</b>	1. A Must filled setting 2. The value is <b>1500</b> by default	Specify the <b>Tunnel MTU</b> . <b>Value Range: 0 ~ 1500.</b>
<b>Tunnel UDP Fragment</b>	1. A Must filled setting 2. The value is <b>1500</b> by default	Specify the <b>Tunnel UDP Fragment</b> . By default, it is equal to <b>Tunnel MTU</b> . <b>Value Range: 0 ~ 1500.</b> Note: Tunnel UDP Fragment will be available only when UDP is chosen in

# 4G IIoT Gateway

---

		Protocol.
<b>Tunnel UDP MSS-Fix</b>	<ol style="list-style-type: none"><li>1. An Optional setting.</li><li>2. The box is unchecked by default.</li></ol>	Check the <b>Enable</b> box to activate the <b>Tunnel UDP MSS-Fix</b> Function. Note: Tunnel UDP MSS-Fix will be available only when UDP is chosen in Protocol.
<b>CCD-Dir Default File</b>	<ol style="list-style-type: none"><li>1. An Optional setting.</li><li>2. String format: any text</li></ol>	Specify the <b>CCD-Dir Default File</b> . <b><i>Value Range: 0 ~ 256 characters.</i></b>
<b>Client Connection Script</b>	<ol style="list-style-type: none"><li>1. An Optional setting.</li><li>2. String format: any text</li></ol>	Specify the <b>Client Connection Script</b> . <b><i>Value Range: 0 ~ 256 characters.</i></b>
<b>Additional Configuration</b>	<ol style="list-style-type: none"><li>1. An Optional setting.</li><li>2. String format: any text</li></ol>	Specify the <b>Additional Configuration</b> . <b><i>Value Range: 0 ~ 256 characters.</i></b>

# 4G IIoT Gateway

## As an OpenVPN Client

If **Client** is selected, an OpenVPN Client List screen will appear.

OpenVPN Client List <span>Add</span> <span>Delete</span>														
ID	Client Name	Interface	Protocol	Port	Tunnel Scenario	Remote IP/FQDN	Remote Subnet	Redirect Internet Traffic	NAT	Authorization Mode	Encryption Cipher	Hash Algorithm	Enable	Actions

When **Add** button is applied, OpenVPN Client Configuration screen will appear. **OpenVPN Client Configuration** window let you specify the required parameters for an OpenVPN VPN client, such as "OpenVPN Client Name", "Interface", "Protocol", "Tunnel Scenario", "Remote IP/FQDN", "Remote Subnet", "Authorization Mode", "Encryption Cipher", "Hash Algorithm" and tunnel activation.

OpenVPN Client Configuration	
Item	Setting
▶ OpenVPN Client Name	<input type="text" value="OpenVPN Client #1"/>
▶ Interface	<input type="text" value="WAN 1"/>
▶ Protocol	<input type="text" value="TCP"/> Port: <input type="text" value="443"/>
▶ Tunnel Scenario	<input type="text" value="TUN"/>
▶ Remote IP/FQDN	<input type="text"/>
▶ Remote Subnet	<input type="text"/> <input type="text" value="255.255.255.0(/24)"/>
▶ Redirect Internet Traffic	<input type="checkbox"/> Enable
▶ NAT	<input checked="" type="checkbox"/> Enable
▶ Authorization Mode	<input type="text" value="TLS"/> CA Cert.: <input type="text"/> Client Cert.: <input type="text"/> Client Key.: <input type="text"/> <span style="color: red;">Please set the Certificate.</span>
▶ Encryption Cipher	<input type="text" value="Blowfish"/>
▶ Hash Algorithm	<input type="text" value="SHA-1"/>
▶ LZO Compression	<input type="text" value="Adaptive"/>
▶ Persist Key	<input checked="" type="checkbox"/> Enable
▶ Persist Tun	<input checked="" type="checkbox"/> Enable
▶ Advanced Configuration	<input type="button" value="Edit"/>
▶ Tunnel	<input type="checkbox"/> Enable

# 4G IIoT Gateway

OpenVPN Client Configuration		
Item	Value setting	Description
<b>OpenVPN Client Name</b>	A Must filled setting	The <b>OpenVPN Client Name</b> will be used to identify the client in the tunnel list. <b>Value Range:</b> 1 ~ 32 characters.
<b>Interface</b>	1. A Must filled setting 2. By default <b>WAN-1</b> is selected.	Define the physical interface to be used for this OpenVPN Client tunnel.
<b>Protocol</b>	1. A Must filled setting 2. By default <b>TCP</b> is selected.	Define the <b>Protocol</b> for the OpenVPN Client. <ul style="list-style-type: none"> <li>• Select <b>TCP</b> -&gt;The OpenVPN will use TCP protocol, and <b>Port</b> will be set as 443 automatically.</li> <li>• Select <b>UDP</b> -&gt; The OpenVPN will use UDP protocol, and <b>Port</b> will be set as 1194 automatically.</li> </ul>
<b>Port</b>	1. A Must filled setting 2. By default <b>443</b> is set.	Specify the <b>Port</b> for the OpenVPN Client to use. <b>Value Range:</b> 1 ~ 65535.
<b>Tunnel Scenario</b>	1. A Must filled setting 2. By default <b>TUN</b> is selected.	Specify the type of <b>Tunnel Scenario</b> for the OpenVPN Client to use. It can be <b>TUN</b> for TUN tunnel scenario, or <b>TAP</b> for TAP tunnel scenario.
<b>Remote IP/FQDN</b>	A Must filled setting	Specify the <b>Remote IP/FQDN</b> of the peer OpenVPN Server for this OpenVPN Client tunnel. Fill in the IP address or FQDN.
<b>Remote Subnet</b>	1. An Optional setting. 2. The box is unchecked by default.	Check the <b>Enable</b> box to activate remote subnet function, and specify <b>Remote Subnet</b> of the peer OpenVPN Server for this OpenVPN Client tunnel. Fill in the remote subnet address and remote subnet mask.
<b>Redirect Internet Traffic</b>	1. An Optional setting. 2. The box is unchecked by default.	Check the <b>Enable</b> box to activate the <b>Redirect Internet Traffic</b> function.
<b>NAT</b>	1. An Optional setting. 2. The box is unchecked by default.	Check the <b>Enable</b> box to activate the <b>NAT</b> function.
<b>Authorization Mode</b>	1. A Must filled setting 2. By default <b>TLS</b> is selected.	Specify the authorization mode for the OpenVPN Server. <ul style="list-style-type: none"> <li>• <b>TLS</b> -&gt;The OpenVPN will use TLS authorization mode, and the following items <b>CA Cert.</b>, <b>Client Cert.</b> and <b>Client Key</b> will be displayed. <b>CA Cert.</b> could be selected in Trusted CA Certificate List. Refer to <b>Object Definition &gt; Certificate &gt; Trusted Certificate</b>. <b>Client Cert.</b> could be selected in Local Certificate List. Refer to <b>Object Definition &gt; Certificate &gt; My Certificate</b>. <b>Client Key</b> could be selected in Trusted Client key List. Refer to <b>Object Definition &gt; Certificate &gt; Trusted Certificate</b>.</li> <li>• <b>Static Key</b> -&gt;The OpenVPN will use static key authorization mode, and the following items <b>Local Endpoint IP Address</b>, <b>Remote Endpoint IP Address</b> and <b>Static Key</b> will be displayed.</li> </ul>
<b>Local Endpoint IP Address</b>	A Must filled setting	Specify the virtual <b>Local Endpoint IP Address</b> of this OpenVPN gateway. <b>Value Range:</b> The IP format is 10.8.0.x, the range of x is 1~254. Note: Local Endpoint IP Address will be available only when Static Key is chosen in Authorization Mode.

# 4G IIoT Gateway

<b>Remote Endpoint IP Address</b>	A Must filled setting	Specify the virtual <b>Remote Endpoint IP Address</b> of the peer OpenVPN gateway. <b>Value Range:</b> The IP format is 10.8.0.x, the range of x is 1~254. Note: Remote Endpoint IP Address will be available only when Static Key is chosen in Authorization Mode.
<b>Static Key</b>	A Must filled setting	Specify the <b>Static Key</b> . Note: Static Key will be available only when Static Key is chosen in Authorization Mode.
<b>Encryption Cipher</b>	By default <b>Blowfish</b> is selected.	Specify the <b>Encryption Cipher</b> . It can be <b>Blowfish/AES-256/AES-192/AES-128/None</b> .
<b>Hash Algorithm</b>	By default <b>SHA-1</b> is selected.	Specify the <b>Hash Algorithm</b> . It can be <b>SHA-1/MD5/MD4/SHA2-256/SHA2-512/None/Disable</b> .
<b>LZO Compression</b>	By default <b>Adaptive</b> is selected.	Specify the <b>LZO Compression</b> scheme. It can be <b>Adaptive/YES/NO/Default</b> .
<b>Persis Key</b>	1. An Optional setting. 2. The box is checked by default.	Check the <b>Enable</b> box to activate the <b>Persis Key</b> function.
<b>Persis Tun</b>	1. An Optional setting. 2. The box is checked by default.	Check the <b>Enable</b> box to activate the <b>Persis Tun</b> function.
<b>Advanced Configuration</b>	N/A	Click the <b>Edit</b> button to specify the <b>Advanced Configuration</b> setting for the OpenVPN server. If the button is clicked, <b>Advanced Configuration</b> will be displayed below.
<b>Tunnel</b>	The box is unchecked by default	Check the <b>Enable</b> box to activate this OpenVPN tunnel.
<b>Save</b>	N/A	Click <b>Save</b> to save the settings.
<b>Undo</b>	N/A	Click <b>Undo</b> to cancel the changes.
<b>Back</b>	N/A	Click <b>Back</b> to return to last page.

# 4G IIoT Gateway

When **Advanced Configuration** is selected, an OpenVPN Client Advanced Configuration screen will appear.

OpenVPN Client Advanced Configuration	
Item	Setting
▶ TLS Cipher	TLS-RSA-WITH-AES128-SHA ▼
▶ TLS Auth. Key(Optional)	<input type="text"/> (Optional)
▶ User Name(Optional)	<input type="text"/> (Optional)
▶ Password(Optional)	<input type="text"/> (Optional)
▶ Bridge TAP to	VLAN 1 ▼
▶ Firewall Protection	<input type="checkbox"/> Enable
▶ Client IP Address	Dynamic IP ▼
▶ Tunnel MTU	<input type="text" value="1500"/>
▶ Tunnel UDP Fragment	<input type="text" value="1500"/>
▶ Tunnel UDP MSS-Fix	<input type="checkbox"/> Enable
▶ nsCertType Verification	<input type="checkbox"/> Enable
▶ TLS Renegotiation Time(seconds)	<input type="text" value="3600"/> (seconds)
▶ Connection Retry(seconds)	<input type="text" value="-1"/> (seconds)
▶ DNS	Automatically ▼
▶ Additional Configuration	<input type="text"/>

OpenVPN Advanced Client Configuration		
Item	Value setting	Description
<b>TLS Cipher</b>	1. A Must filled setting. 2. <b>TLS-RSA-WITH-AES128-SHA</b> is selected by default	Specify the <b>TLS Cipher</b> from the dropdown list. It can be <b>None / TLS-RSA-WITH-RC4-MD5 / TLS-RSA-WITH-AES128-SHA / TLS-RSA-WITH-AES256-SHA / TLS-DHE-DSS-AES128-SHA / TLS-DHE-DSS-AES256-SHA</b> . Note: TLS Cipher will be available only when TLS is chosen in Authorization Mode.
<b>TLS Auth. Key</b>	1. An Optional setting. 2. String format: any text	Specify the <b>TLS Auth. Key</b> for connecting to an OpenVPN server, if the server required it. Note: TLS Auth. Key will be available only when TLS is chosen in Authorization Mode.

## 4G IIoT Gateway

<b>User Name</b>	An Optional setting.	Enter the <b>User account</b> for connecting to an OpenVPN server, if the server required it. Note: User Name will be available only when TLS is chosen in Authorization Mode.
<b>Password</b>	An Optional setting.	Enter the <b>Password</b> for connecting to an OpenVPN server, if the server required it. Note: User Name will be available only when TLS is chosen in Authorization Mode.
<b>Bridge TAP to</b>	By default <b>VLAN 1</b> is selected	Specify the setting of " <b>Bridge TAP to</b> " to bridge the TAP interface to a certain local network interface or VLAN. Note: Bridge TAP to will be available only when TAP is chosen in Tunnel Scenario and NAT is unchecked.
<b>Firewall Protection</b>	The box is unchecked by default.	Check the box to activate the <b>Firewall Protection</b> function. Note: Firewall Protection will be available only when NAT is enabled.
<b>Client IP Address</b>	By default <b>Dynamic IP</b> is selected	Specify the virtual IP Address for the OpenVPN Client. It can be <b>Dynamic IP/Static IP</b> .
<b>Tunnel MTU</b>	1.A Must filled setting 2.The value is 1500 by default	Specify the value of <b>Tunnel MTU</b> . <b>Value Range: 0 ~ 1500.</b>
<b>Tunnel UDP Fragment</b>	The value is 1500 by default	Specify the value of <b>Tunnel UDP Fragment</b> . <b>Value Range: 0 ~ 1500.</b> Note: Tunnel UDP Fragment will be available only when UDP is chosen in Protocol.
<b>Tunnel UDP MSS-Fix</b>	The box is unchecked by default.	Check the <b>Enable</b> box to activate the <b>Tunnel UDP MSS-Fix</b> function. Note: Tunnel UDP MSS-Fix will be available only when UDP is chosen in Protocol.
<b>nsCerType Verification</b>	The box is unchecked by default.	Check the <b>Enable</b> box to activate the <b>nsCerType Verification</b> function. Note: nsCerType Verification will be available only when TLS is chosen in Authorization Mode.
<b>TLS Renegotiation Time (seconds)</b>	The value is 3600 by default	Specify the time interval of <b>TLS Renegotiation Time</b> . <b>Value Range: -1 ~ 86400.</b>
<b>Connection Retry(seconds)</b>	The value is -1 by default	Specify the time interval of <b>Connection Retry</b> . The default -1 means that it is no need to execute connection retry. <b>Value Range: -1 ~ 86400, and -1 means no retry is required.</b>
<b>DNS</b>	By default <b>Automatically</b> is selected	Specify the setting of <b>DNS</b> . It can be <b>Automatically/Manually</b> .
<b>Additional Configuration</b>	An Optional setting.	Enter optional configuration string here. Up to 256 characters is allowable. <b>Value Range: 0 ~ 256characters.</b>
<b>Save</b>	N/A	Click <b>Save</b> to save the settings.
<b>Undo</b>	N/A	Click <b>Undo</b> to cancel the changes.
<b>Back</b>	N/A	Click <b>Back</b> to return to last page.

# 4G IIoT Gateway

## 5.1.3 L2TP

Configuration <span style="float: right;">[ Help ]</span>	
Item	Setting
▶ L2TP	<input checked="" type="checkbox"/> Enable
▶ Client/Server	Server ▼

L2TP Server Configuration	
Item	Setting
▶ L2TP Server	<input type="checkbox"/> Enable
▶ L2TP over IPsec	<input type="checkbox"/> Enable Preshared Key <input type="text"/> (Min. 8 characters)
▶ Server Virtual IP	<input type="text" value="192.168.10.1"/>
▶ IP Pool Starting Address	<input type="text" value="10"/>
▶ IP Pool Ending Address	<input type="text" value="17"/>
▶ Authentication Protocol	<input type="checkbox"/> PAP <input type="checkbox"/> CHAP <input type="checkbox"/> MS-CHAP <input type="checkbox"/> MS-CHAP v2
▶ MPPE Encryption	<input type="checkbox"/> Enable <input type="text" value="40 bits"/> ▼
▶ Service Port	<input type="text" value="1701"/>

L2TP Server Status <span style="float: right;">Refresh</span>				
User Name	Remote IP	Remote Virtual IP	Remote Call ID	Actions
No connection from remote				

User Account List <span style="float: right;">Add Delete</span>				
ID	User Name	Password	Enable	Actions

Layer 2 Tunneling Protocol (L2TP) is a tunneling protocol used to support virtual private networks (VPNs) or as part of the delivery of services by ISPs. It does not provide any encryption or confidentiality by itself. Rather, it relies on an encryption protocol that it passes within the tunnel to provide privacy. This Gateway can behave as a L2TP server and a L2TP client both at the same time.

**L2TP Server:** It must have a static IP or a FQDN for clients to create L2TP tunnels. It also maintains “User Account list” (user name/ password) for client login authentication; There is a virtual IP pool to assign virtual IP to each connected L2TP client.

**L2TP Client:** It can be mobile users or gateways in remote offices with dynamic IP. To setup tunnel, it should get “user name”, “password” and server’s global IP. In addition, it is required to identify the operation mode for each tunnel as main connection, failover for another tunnel, or load balance tunnel to increase overall bandwidth. It needs to decide “Default Gateway” or “Remote Subnet” for packet flow. Moreover, you can also define what kind of traffics will pass through the L2TP tunnel in the “Default Gateway / Remote Subnet” parameter.

# 4G IIoT Gateway

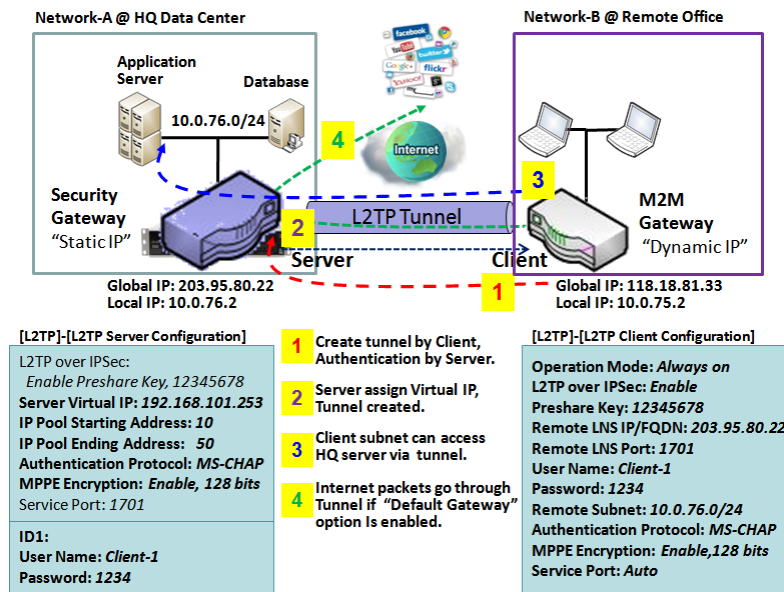

L2TP tunnel.

Besides, for the L2TP client peer, a Remote Subnet item is required. It is for the Intranet of L2TP server peer. So, at L2TP client peer, the packets whose destination is in the dedicated subnet will be transferred via the L2TP tunnel. Others will be transferred based on current routing policy of the gateway at L2TP client peer. But, if you entered 0.0.0.0/0 in the Remote Subnet field, it will be treated as a "Default Gateway" setting for the L2TP client peer, all packets, including the Internet accessing of L2TP client peer, will go through the established L2TP tunnel. That means the remote L2TP server peer controls the flow of any packets from the L2TP client peer. Certainly, those packets come through the

# 4G IloT Gateway

## L2TP Setting

Go to **Security > VPN > L2TP** tab.

The L2TP setting allows user to create and configure L2TP tunnels.

### Enable L2TP

Configuration <span style="float: right;">[ Help ]</span>	
Item	Setting
▶ L2TP	<input type="checkbox"/> Enable
▶ Client/Server	Server ▼

Enable L2TP Window		
Item	Value setting	Description
<b>L2TP</b>	Unchecked by default	Click the <b>Enable</b> box to activate L2TP function.
<b>Client/Server</b>	A Must filled setting	Specify the role of L2TP. Select <b>Server</b> or <b>Client</b> role your gateway will take. Below are the configuration windows for L2TP Server and for Client.
<b>Save</b>	N/A	Click <b>Save</b> button to save the settings

### As a L2TP Server

When select **Server** in Client/Server, the L2TP server Configuration will appear.

L2TP Server Configuration	
Item	Setting
▶ L2TP Server	<input type="checkbox"/> Enable
▶ L2TP over IPsec	<input type="checkbox"/> Enable Preshared Key <input type="text"/> (Min. 8 characters)
▶ Server Virtual IP	<input type="text" value="192.168.10.1"/>
▶ IP Pool Starting Address	<input type="text" value="10"/>
▶ IP Pool Ending Address	<input type="text" value="17"/>
▶ Authentication Protocol	<input type="checkbox"/> PAP <input type="checkbox"/> CHAP <input type="checkbox"/> MS-CHAP <input type="checkbox"/> MS-CHAP v2
▶ MPPE Encryption	<input type="checkbox"/> Enable <input type="text" value="40 bits"/> ▼
▶ Service Port	<input type="text" value="1701"/>

# 4G IIoT Gateway

L2TP Server Configuration		
Item	Value setting	Description
L2TP Server	The box is unchecked by default	When click the <b>Enable</b> box It will active L2TP server
L2TP over IPsec	The box is unchecked by default	When click the <b>Enable</b> box. It will enable L2TP over IPsec and need to fill in the Pre-shared Key (8~32 characters).
Server Virtual IP	A Must filled setting	Specify the L2TP server Virtual IP It will set as this L2TP server local virtual IP
IP Pool Starting Address	1. A Must filled setting 2. <b>10</b> is set by default.	Specify the L2TP server starting IP of virtual IP pool It will set as the starting IP which assign to L2TP client <b>Value Range:</b> 1 ~ 254.
IP Pool Ending Address	1. A Must filled setting 2. <b>17</b> is set by default.	Specify the L2TP server ending IP of virtual IP pool It will set as the ending IP which assign to L2TP client <b>Value Range:</b> >= Starting Address, and < (Starting Address + 8) or 254.
Authentication Protocol	A Must filled setting	Select single or multiple Authentication Protocols for the L2TP server with which to authenticate L2TP clients. Available authentication protocols are <b>PAP / CHAP / MS-CHAP / MS-CHAP v2</b> .
MPPE Encryption	A Must filled setting	Specify whether to support MPPE Protocol. Click the <b>Enable</b> box to enable MPPE and from dropdown box to select <b>40 bits / 56 bits / 128 bits</b> . Note: when MPPE Encryption is enabled, the Authentication Protocol <b>PAP / CHAP</b> options will not be available.
Service Port	A Must filled setting	Specify the <b>Service Port</b> which L2TP server use. <b>Value Range:</b> 1 ~ 65535.
Save	N/A	Click the <b>Save</b> button to save the configuration.
Undo	N/A	Click the <b>Undo</b> button to recovery the configuration.

L2TP Server Status <span>Refresh</span>				
User Name	Remote IP	Remote Virtual IP	Remote Call ID	Actions
No connection from remote				

L2TP Server Status		
Item	Value setting	Description
L2TP Server Status	N/A	It displays the User Name, Remote IP, Remote Virtual IP, and Remote Call ID of the connected L2TP clients. Click the <b>Refresh</b> button to renew the L2TP client information.

# 4G IIoT Gateway

User Account List <input type="button" value="Add"/> <input type="button" value="Delete"/>				
ID	User Name	Password	Enable	Actions
<b>User Account Configuration</b>				
User Name		Password		Account
<input type="text"/>		<input type="text"/>		<input type="checkbox"/> Enable
<input type="button" value="Save"/>				

User Account List Window		
Item	Value setting	Description
User Account List	Max.of 10 user accounts	<p>This is the L2TP authentication user account entry. You can create and add accounts for remote clients to establish L2TP VPN connection to the gateway device.</p> <p>Click <b>Add</b> button to add user account. Enter User name and password. Then check the <b>enable</b> box to enable the user.</p> <p>Click <b>Save</b> button to save new user account.</p> <p>The selected user account can permanently be deleted by clicking the <b>Delete</b> button.</p> <p><b>Value Range:</b> 1 ~ 32 characters.</p>

## As a L2TP Client

When select Client in Client/Server, a series L2TP Client Configuration will appear.

L2TP Client Configuration	
Item	Setting
▶ L2TP Client	<input type="checkbox"/> Enable

L2TP Client Configuration		
Item Setting	Value setting	Description
L2TP Client	The box is unchecked by default	Check the <b>Enable</b> box to enable L2TP client role of the gateway.
Save	N/A	Click <b>Save</b> button to save the settings.
Undo	N/A	Click <b>Undo</b> button to cancel the settings.

# 4G IIoT Gateway

## Create/Edit L2TP Client

L2TP Client List & Status								
<input type="button" value="Add"/> <input type="button" value="Delete"/> <input type="button" value="Refresh"/>								
ID	Tunnel Name	Interface	Virtual IP	Remote IP/FQDN	Remote Subnet	Status	Enable	Actions

When **Add/Edit** button is applied, a series of configuration screen will appear. You can add up to 8 L2TP Clients.

L2TP Client Configuration	
Item	Setting
▶ Tunnel Name	<input type="text" value="L2TP #1"/>
▶ Interface	<input type="text" value="WAN1"/>
▶ Operation Mode	<input type="text" value="Always on"/>
▶ L2TP over IPsec	<input type="checkbox"/> Enable Preshared Key <input type="text"/> (Min. 8 characters)
▶ Remote LNS IP/FQDN	<input type="text"/>
▶ Remote LNS Port	<input type="text" value="1701"/>
▶ User Name	<input type="text"/>
▶ Password	<input type="text"/>
▶ Tunneling Password (Optional)	<input type="text"/>
▶ Remote Subnet	<input type="text"/>
▶ Authentication Protocol	<input type="checkbox"/> PAP <input type="checkbox"/> CHAP <input type="checkbox"/> MS-CHAP <input type="checkbox"/> MS-CHAP v2
▶ MPPE Encryption	<input type="checkbox"/> Enable
▶ LCP Echo Type	<input type="text" value="Auto"/> Interval <input type="text" value="30"/> seconds Max. Failure Time <input type="text" value="6"/> times
▶ Service Port	<input type="text" value="Auto"/> <input type="text" value="0"/>
▶ Tunnel	<input type="checkbox"/> Enable

L2TP Client Configuration		
Item Setting	Value setting	Description
<b>Tunnel Name</b>	A Must filled setting	Enter a tunnel name. Enter a name that is easy for you to identify. <b>Value Range:</b> 1 ~ 32 characters.

# 4G IIoT Gateway

<b>Interface</b>	A Must filled setting	Define the selected interface to be the used for this L2TP tunnel ( <b>WAN-1</b> is available only when WAN-1 interface is enabled) The same applies to other WAN interfaces (e.g. <b>WAN-2</b> ).
<b>Operation Mode</b>	1. A Must filled setting 2. <b>Always on</b> is selected by default	Define operation mode for the L2TP Tunnel. It can be <b>Always On</b> , or <b>Failover</b> . If this tunnel is set as a failover tunnel, you need to further select a primary tunnel from which to failover to. Note: <b>Failover</b> mode is not available for the gateway with single WAN.
<b>L2TP over IPSec</b>	The box is unchecked by default	Check the <b>Enable</b> box to activate L2TP over IPSec, and further specify a Pre-shared Key ( <b>8~32 characters</b> ).
<b>Remote LNS IP/FQDN</b>	A Must filled setting	Enter the public IP address or the FQDN of the L2TP server.
<b>Remote LNS Port</b>	1. A Must filled setting 2. <b>1701</b> is set by default	Enter the Remote LNS Port for this L2TP tunnel. <b>Value Range: 1 ~ 65535.</b>
<b>User Name</b>	A Must filled setting	Enter the <b>User Name</b> for this L2TP tunnel to be authenticated when connect to L2TP server. <b>Value Range: 1 ~ 32 characters.</b>
<b>Password</b>	A Must filled setting	Enter the <b>Password</b> for this L2TP tunnel to be authenticated when connect to L2TP server.
<b>Tunneling Password(Optional)</b>	The box is unchecked by default	Enter the <b>Tunneling Password</b> for this L2TP tunnel to authenticate.
<b>Remote Subnet</b>	A Must filled setting	Specify the remote subnet for this L2TP tunnel to reach L2TP server. The Remote Subnet format must be IP address/netmask (e.g. 10.0.0.2/24). It is for the Intranet of L2TP VPN server. So, at L2TP client peer, the packets whose destination is in the dedicated subnet will be transferred via the L2TP VPN tunnel. Others will be transferred based on current routing policy of the security gateway at L2TP client peer.  If you entered 0.0.0.0/0 in the Remote Subnet field, it will be treated as a default gateway setting for the L2TP client peer, all packets, including the Internet accessing of L2TP Client peer, will go through the established L2TP VPN tunnel. That means the remote L2TP VPN server controls the flow of any packets from the L2TP client peer. Certainly, those packets come through the L2TP VPN tunnel.
<b>Authentication Protocol</b>	1. A Must filled setting 2. Unchecked by default	Specify one ore multiple <b>Authentication Protocol</b> for this L2TP tunnel. Available authentication methods are <b>PAP / CHAP / MS-CHAP / MS-CHAP v2</b> .
<b>MPPE Encryption</b>	1. Unchecked by default 2. an optional setting	Specify whether L2TP server supports <b>MPPE Protocol</b> . Click the <b>Enable</b> box to enable MPPE. Note: when MPPE Encryption is enabled, the Authentication Protocol <b>PAP / CHAP</b> options will not be available.
<b>LCP Echo Type</b>	1. Auto is set by default	Specify the LCP Echo Type for this L2TP tunnel. It can be <b>Auto</b> , <b>User-defined</b> , or <b>Disable</b> . <b>Auto</b> : the system sets the Interval and Max. Failure Time. <b>User-defined</b> : enter the Interval and Max. Failure Time. The default value for Interval is 30 seconds, and Maximum Failure Times is 6 Times.

# 4G IIoT Gateway

		<b>Disable:</b> disable the LCP Echo. <b>Value Range:</b> 1 ~ 99999 for Interval Time, 1~999 for Failure Time.
<b>Service Port</b>	A Must filled setting	Specify the <b>Service Port</b> for this L2TP tunnel to use. It can be <b>Auto</b> , <b>(1701) for Cisco</b> , or <b>User-defined</b> . <b>Auto:</b> The system determines the service port. <b>1701 (for Cisco):</b> The system use port 1701 for connecting with CISCO L2TP Server. <b>User-defined:</b> Enter the service port. The default value is 0. <b>Value Range:</b> 0 ~ 65535.
<b>Tunnel</b>	Unchecked by default	Check the <b>Enable</b> box to enable this L2TP tunnel.
<b>Save</b>	N/A	Click <b>Save</b> button to save the settings.
<b>Undo</b>	N/A	Click <b>Undo</b> button to cancel the settings.
<b>Back</b>	N/A	Click <b>Back</b> button to return to the previous page.

# 4G IIoT Gateway

## 5.1.4 PPTP

Configuration <span style="float: right;">[ Help ]</span>	
Item	Setting
▶ PPTP	<input type="checkbox"/> Enable
▶ Client/Server	Server ▾

PPTP Server Configuration	
Item	Setting
▶ PPTP Server	<input type="checkbox"/> Enable
▶ Server Virtual IP	192.168.0.1
▶ IP Pool Starting Address	10
▶ IP Pool Ending Address	17
▶ Authentication Protocol	<input type="checkbox"/> PAP <input type="checkbox"/> CHAP <input type="checkbox"/> MS-CHAP <input type="checkbox"/> MS-CHAP v2
▶ MPPE Encryption	<input type="checkbox"/> Enable 40 bits ▾

PPTP Server Status <span>Refresh</span>				
User Name	Remote IP	Remote Virtual IP	Remote Call ID	Actions
No connection from remote				

User Account List <span>Add</span> <span>Delete</span>				
ID	User Name	Password	Enable	Actions

Point-to-Point Tunneling Protocol (PPTP) is a method for implementing virtual private networks. PPTP uses a control channel over TCP and a GRE tunnel operating to encapsulate PPP packets. It is a client-server based technology. There are various levels of authentication and encryption for PPTP tunneling, usually natively as standard features of the Windows PPTP stack. The security gateway can play either "PPTP Server" role or "PPTP Client" role for a PPTP VPN tunnel, or both at the same time for different tunnels. PPTP tunnel process is nearly the same as L2TP.

**PPTP Server:** It must have a static IP or a FQDN for clients to create PPTP tunnels. It also maintains "User Account list" (user name / password) for client login authentication; There is a virtual IP pool to assign virtual IP to each connected PPTP client.

**PPTP Client:** It can be mobile users or gateways in remote offices with dynamic IP. To setup tunnel, it should

# 4G IIoT Gateway

get “user name”, “password” and server’s global IP. In addition, it is required to identify the operation mode for each tunnel as main connection, failover for another tunnel, or load balance tunnel to increase overall bandwidth. It needs to decide “Default Gateway” or “Remote Subnet” for packet flow. Moreover, you can also define what kind of traffics will pass through the PPTP tunnel in the “Default Gateway / Remote Subnet” parameter.

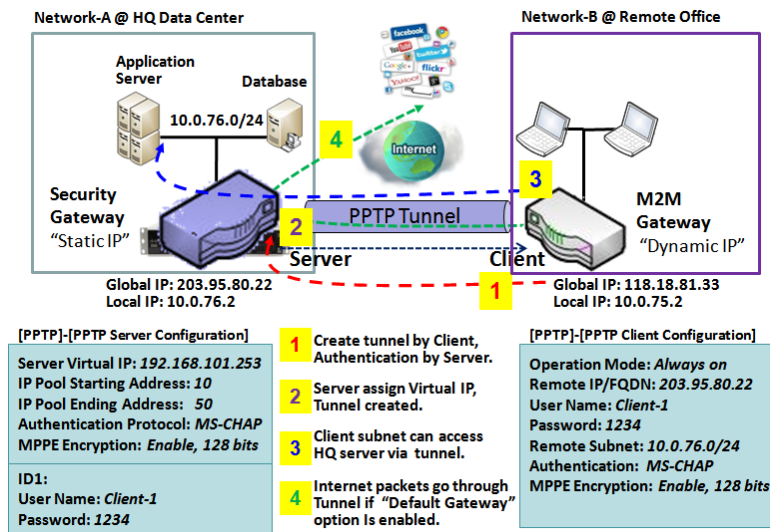

Besides, for the PPTP client peer, a Remote Subnet item is required. It is for the Intranet of PPTP server peer. So, at PPTP client peer, the packets whose destination is in the dedicated subnet will be transferred via the PPTP tunnel. Others will be transferred based on current routing policy of the gateway at PPTP client peer. But, if you entered 0.0.0.0/0 in the Remote Subnet field, it will be treated as a "Default Gateway" setting for the PPTP client peer, all packets, including the Internet accessing of PPTP client peer, will go through the established PPTP tunnel. That means the remote PPTP server peer controls the flow of

any packets from the PPTP client peer. Certainly, those packets come through the PPTP tunnel.

# 4G IIoT Gateway

## PPTP Setting

Go to **Security > VPN > PPTP** tab.

The PPTP setting allows user to create and configure PPTP tunnels.

### Enable PPTP

Configuration <span style="float: right;">[ Help ]</span>	
Item	Setting
▶ PPTP	<input type="checkbox"/> Enable
▶ Client/Server	Server ▼

Enable PPTP Window		
Item	Value setting	Description
<b>PPTP</b>	Unchecked by default	Click the <b>Enable</b> box to activate PPTP function.
<b>Client/Server</b>	A Must fill setting	Specify the role of PPTP. Select <b>Server</b> or <b>Client</b> role your gateway will take. Below are the configuration windows for PPTP Server and for Client.
<b>Save</b>	N/A	Click <b>Save</b> button to save the settings.

### As a PPTP Server

The gateway supports up to a maximum of 10 PPTP user accounts.

When **Server** in the Client/Server field is selected, the PPTP server configuration window will appear.

PPTP Server Configuration	
Item	Setting
▶ PPTP Server	<input type="checkbox"/> Enable
▶ Server Virtual IP	192.168.0.1
▶ IP Pool Starting Address	10
▶ IP Pool Ending Address	17
▶ Authentication Protocol	<input type="checkbox"/> PAP <input type="checkbox"/> CHAP <input type="checkbox"/> MS-CHAP <input type="checkbox"/> MS-CHAP v2
▶ MPPE Encryption	<input type="checkbox"/> Enable 40 bits ▼

# 4G IIoT Gateway

PPTP Server Configuration Window		
Item	Value setting	Description
<b>PPTP Server</b>	Unchecked by default	Check the <b>Enable</b> box to enable PPTP server role of the gateway.
<b>Server Virtual IP</b>	1. A Must fill setting 2. Default is 192.168.0.1	Specify the PPTP server Virtual IP address. The virtual IP address will serve as the virtual DHCP server for the PPTP clients. Clients will be assigned a virtual IP address from it after the PPTP tunnel has been established.
<b>IP Pool Starting Address</b>	1. A Must fill setting 2. Default is <b>10</b>	This is the PPTP server's Virtual IP DHCP server. User can specify the first IP address for the subnet from which the PPTP client's IP address will be assigned. <b>Value Range: 1 ~ 254.</b>
<b>IP Pool Ending Address</b>	1. A Must fill setting 2. Default is <b>17</b>	This is the PPTP server's Virtual IP DHCP server. User can specify the last IP address for the subnet from which the PPTP client's IP address will be assigned. <b>Value Range: &gt;= Starting Address, and &lt; (Starting Address + 8) or 254.</b>
<b>Authentication Protocol</b>	1. A Must fill setting 2. Unchecked by default	Select single or multiple Authentication Protocols for the PPTP server with which to authenticate PPTP clients. Available authentication protocols are <b>PAP / CHAP / MS-CHAP / MS-CHAP v2.</b>
<b>MPPE Encryption</b>	1. A Must fill setting 2. Unchecked by default	Specify whether to support MPPE Protocol. Click the <b>Enable</b> box to enable MPPE and from dropdown box to select <b>40 bits / 56 bits / 128 bits.</b> Note: when MPPE Encryption is enabled, the Authentication Protocol <b>PAP / CHAP</b> options will not be available.
<b>Save</b>	N/A	Click <b>Save</b> button to save the settings.
<b>Undo</b>	N/A	Click <b>Undo</b> button to cancel the settings.

PPTP Server Status <input type="button" value="Refresh"/>				
User Name	Remote IP	Remote Virtual IP	Remote Call ID	Actions
No connection from remote				

PPTP Server Status Window		
Item	Value setting	Description
<b>PPTP Server Status</b>	N/A	It displays the User Name, Remote IP, Remote Virtual IP, and Remote Call ID of the connected PPTP clients. Click the <b>Refresh</b> button to renew the PPTP client information.

User Account List <input type="button" value="Add"/> <input type="button" value="Delete"/>				
ID	User Name	Password	Enable	Actions
User Account Configuration				
User Name	Password		Account	
<input type="text"/>	<input type="text"/>		<input type="checkbox"/> Enable	
<input type="button" value="Save"/>				

# 4G IIoT Gateway

User Account List Window		
Item	Value setting	Description
User Account List	Max.of 10 user accounts	<p>This is the PPTP authentication user account entry. You can create and add accounts for remote clients to establish PPTP VPN connection to the gateway device.</p> <p>Click <b>Add</b> button to add user account. Enter User name and password. Then check the <b>enable</b> box to enable the user.</p> <p>Click <b>Save</b> button to save new user account.</p> <p>The selected user account can permanently be deleted by clicking the <b>Delete</b> button.</p> <p><b>Value Range:</b> 1 ~ 32 characters.</p>

## As a PPTP Client

When select Client in Client/Server, a series PPTP Client Configuration will appear.

PPTP Client Configuration	
Item	Setting
PPTP Client	<input type="checkbox"/> Enable

PPTP Client Configuration		
Item	Value setting	Description
PPTP Client	Unchecked by default	Check the <b>Enable</b> box to enable PPTP client role of the gateway.
Save	N/A	Click <b>Save</b> button to save the settings.
Undo	N/A	Click <b>Undo</b> button to cancel the settings.

## Create/Edit PPTP Client

PPTP Client List & Status								
ID	Tunnel Name	Interface	Virtual IP	Remote IP/FQDN	Remote Subnet	Status	Enable	Actions
<div style="display: flex; justify-content: space-between; align-items: center;"> <span>Add</span> <span>Delete</span> <span>Refresh</span> </div>								

When **Add/Edit** button is applied, a series PPTP Client Configuration will appear.

# 4G IIoT Gateway

PPTP Client Configuration	
Item	Setting
▶ Tunnel Name	<input type="text" value="PPTP #1"/>
▶ Interface	<input type="text" value="WAN1"/>
▶ Operation Mode	<input type="text" value="Always on"/>
▶ Remote IP/FQDN	<input type="text"/>
▶ User Name	<input type="text"/>
▶ Password	<input type="text"/>
▶ Remote Subnet	<input type="text"/>
▶ Authentication Protocol	<input type="checkbox"/> PAP <input type="checkbox"/> CHAP <input type="checkbox"/> MS-CHAP <input type="checkbox"/> MS-CHAP v2
▶ MPPE Encryption	<input type="checkbox"/> Enable
▶ LCP Echo Type	<input type="text" value="Auto"/> Interval <input type="text" value="30"/> seconds Max. Failure Time <input type="text" value="6"/> times
▶ Tunnel	<input type="checkbox"/> Enable

PPTP Client Configuration Window		
Item	Value setting	Description
<b>Tunnel Name</b>	A Must fill setting	Enter a tunnel name. Enter a name that is easy for you to identify. <b>Value Range:</b> 1 ~ 32 characters.
<b>Interface</b>	1. A Must fill setting 2. WAN1 is selected by default	Define the selected interface to be the used for this PPTP tunnel ( <b>WAN-1</b> is available only when WAN-1 interface is enabled) The same applies to other WAN interfaces (e.g. <b>WAN-2</b> ).
<b>Operation Mode</b>	1. A Must fill setting 2. <b>Always on</b> is selected by default	Define operation mode for the PPTP Tunnel. It can be <b>Always On</b> , or <b>Failover</b> . If this tunnel is set as a failover tunnel, you need to further select a primary tunnel from which to failover to. <b>Note: Failover</b> mode is not available for the gateway with single WAN.
<b>Remote IP/FQDN</b>	1. A Must fill setting. 2. Format can be a ipv4 address or FQDN	Enter the public IP address or the FQDN of the PPTP server.
<b>User Name</b>	A Must fill setting	Enter the <b>User Name</b> for this PPTP tunnel to be authenticated when connect to PPTP server. <b>Value Range:</b> 1 ~ 32 characters.
<b>Password</b>	A Must fill setting	Enter the <b>Password</b> for this PPTP tunnel to be authenticated when connect to PPTP server.
<b>Remote Subnet</b>	A Must fill setting	Specify the remote subnet for this PPTP tunnel to reach PPTP server. The Remote Subnet format must be IP address/netmask (e.g. 10.0.0.2/24). It is for the Intranet of PPTP VPN server. So, at PPTP client peer, the packets whose destination is in the dedicated subnet will be transferred via the PPTP

# 4G IIoT Gateway

		<p>VPN tunnel. Others will be transferred based on current routing policy of the security gateway at PPTP client peer.</p> <p>If you entered 0.0.0.0/0 in the Remote Subnet field, it will be treated as a default gateway setting for the PPTP client peer, all packets, including the Internet accessing of PPTP Client peer, will go through the established PPTP VPN tunnel. That means the remote PPTP VPN server controls the flow of any packets from the PPTP client peer. Certainly, those packets come through the PPTP VPN tunnel.</p>
<b>Authentication Protocol</b>	<ol style="list-style-type: none"> <li>1. A Must fill setting</li> <li>2. Unchecked by default</li> </ol>	<p>Specify one ore multiple <b>Authentication Protocol</b> for this PPTP tunnel. Available authentication methods are <b>PAP / CHAP / MS-CHAP / MS-CHAP v2</b>.</p>
<b>MPPE Encryption</b>	<ol style="list-style-type: none"> <li>1. Unchecked by default</li> <li>2. an optional setting</li> </ol>	<p>Specify whether PPTP server supports <b>MPPE Protocol</b>. Click the <b>Enable</b> box to enable MPPE.</p> <p>Note: when MPPE Encryption is enabled, the Authentication Protocol <b>PAP / CHAP</b> options will not be available.</p>
<b>LCP Echo Type</b>	Auto is set by default	<p>Specify the LCP Echo Type for this PPTP tunnel. It can be <b>Auto, User-defined, or Disable</b>.</p> <p><b>Auto:</b> the system sets the Interval and Max. Failure Time.</p> <p><b>User-defined:</b> enter the Interval and Max. Failure Time. The default value for Interval is 30 seconds, and Maximum Failure Times is 6 Times.</p> <p><b>Disable:</b> disable the LCP Echo.</p> <p><b>Value Range:</b> 1 ~ 99999 for Interval Time, 1~999 for Failure Time.</p>
<b>Tunnel</b>	Unchecked by default	Check the <b>Enable</b> box to enable this PPTP tunnel.
<b>Save</b>	N/A	Click <b>Save</b> button to save the settings.
<b>Undo</b>	N/A	Click <b>Undo</b> button to cancel the settings.
<b>Back</b>	N/A	Click <b>Back</b> button to return to the previous page.

# 4G IIoT Gateway

## 5.1.5 GRE

Configuration [ Help ]											
Item	Setting										
GRE Tunnel	<input type="checkbox"/> Enable										
Max. Concurrent GRE Tunnels	<input type="text" value="32"/>										

GRE Tunnel List <input type="button" value="Add"/> <input type="button" value="Delete"/>											
ID	Tunnel Name	Interface	Operation Mode	Tunnel IP	Remote IP	Key	TTL	Keep-alive	Remote Subnet	Enable	Actions

Generic Routing Encapsulation (GRE) is a tunneling protocol developed by Cisco Systems that encapsulates a wide variety of network layer protocols inside virtual point-to-point links over an Internet Protocol internetwork.

Deploy a M2M gateway for remote site and establish a virtual private network with control center by using GRE tunneling. So, all client hosts behind M2M gateway can make data communication with server hosts behind control center gateway.

GRE Tunneling is similar to IPSec Tunneling, client requesting the tunnel establishment with the server. Both the client and the server must have a Static IP or a FQDN. Any peer gateway can be worked as either a client or a server, even using the same set of configuration rule.

### GRE Tunnel Scenario

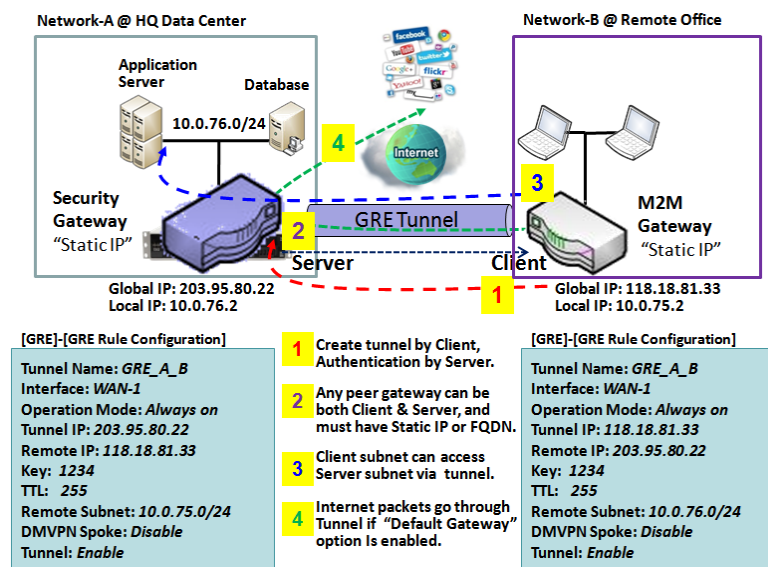

To setup a GRE tunnel, each peer needs to setup its global IP as tunnel IP and fill in the other's global IP as remote IP.

Besides, each peer must further specify the Remote Subnet item. It is for the Intranet of GRE server peer. So, at GRE client peer, the packets whose destination is in the dedicated subnet will be transferred via the GRE tunnel. Others will be transferred based on current routing policy of the gateway at GRE client peer. But, if you entered 0.0.0.0/0 in the Remote Subnet field, it will be treated as a "Default Gateway" setting for the GRE client peer, all packets, including the Internet accessing of GRE client peer, will go through the established GRE

tunnel. That means the remote GRE server peer controls the flow of any packets from the GRE client peer. Certainly, those packets come through the GRE tunnel.

# 4G IIoT Gateway

If the GRE server supports DMVPN Hub function, like Cisco router as the VPN concentrator, the GRE client can active the DMVPN spoke function here since it is implemented by GRE over IPsec tunneling.

## GRE Setting

Go to **Security > VPN > GRE** tab.

The GRE setting allows user to create and configure GRE tunnels.

### Enable GRE

Configuration <span style="float: right;">[ Help ]</span>	
Item	Setting
▶ GRE Tunnel	<input type="checkbox"/> Enable
▶ Max. Concurrent GRE Tunnels	<input type="text" value="32"/>

Enable GRE Window		
Item	Value setting	Description
<b>GRE Tunnel</b>	Unchecked by default	Click the <b>Enable</b> box to enable GRE function.
<b>Max. Concurrent GRE Tunnels</b>	Depends on Product specification.	The specified value will limit the maximum number of simultaneous GRE tunnel connection. The default value can be different for the purchased model.
<b>Save</b>	N/A	Click <b>Save</b> button to save the settings
<b>Undo</b>	N/A	Click <b>Undo</b> button to cancel the settings

### Create/Edit GRE tunnel

GRE Tunnel List <span>Add</span> <span>Delete</span>											
ID	Tunnel Name	Interface	Operation Mode	Tunnel IP	Remote IP	Key	TTL	Keep-alive	Remote Subnet	Enable	Actions

When **Add/Edit** button is applied, a GRE Rule Configuration screen will appear.

# 4G IIoT Gateway

GRE Rule Configuration [ Help ]	
Item	Setting
▶ Tunnel Name	GRE #1
▶ Interface	WAN1 ▼
▶ Operation Mode	Always on ▼
▶ Tunnel IP	IP: <input type="text"/> MASK: -- select one -- ▼ (Optional)
▶ Remote IP	<input type="text"/>
▶ Key	<input type="text"/> (Optional)
▶ TTL	<input type="text"/>
▶ Keep alive	<input type="checkbox"/> Enable Ping IP ▼ <input type="text"/> Interval 5 <input type="text"/> (seconds)
▶ Remote Subnet	<input type="text"/>
▶ DMVPN Spoke	<input type="checkbox"/> Enable
▶ IPsec Pre-shared Key	<input type="text"/> (Min. 8 characters)
▶ IPsec NAT Traversal	<input type="checkbox"/> Enable
▶ IPsec Encapsulation Mode	Transport Mode ▼
▶ Tunnel	<input type="checkbox"/> Enable

GRE Rule Configuration Window		
Item	Value setting	Description
<b>Tunnel Name</b>	A Must fill setting	Enter a tunnel name. Enter a name that is easy for you to identify. <b>Value Range:</b> 1 ~ 9 characters.
<b>Interface</b>	1. A Must fill setting 2. <b>WAN 1</b> is selected by default	Select the interface on which GRE tunnel is to be established. It can be the available WAN and LAN interfaces.
<b>Operation Mode</b>	1. A Must fill setting 2. <b>Always on</b> is selected by default	Define operation mode for the GRE Tunnel. It can be <b>Always On</b> , or <b>Failover</b> . If this tunnel is set as a failover tunnel, you need to further select a primary tunnel from which to failover to. Note: <b>Failover</b> mode is not available for the gateway with single WAN.
<b>Tunnel IP</b>	An Optional setting	Enter the Tunnel IP address and corresponding subnet mask.
<b>Remote IP</b>	A Must fill setting	Enter the Remote IP address of remote GRE tunnel gateway. Normally this is the public IP address of the remote GRE gateway.
<b>Key</b>	An Optional setting	Enter the Key for the GRE connection. <b>Value Range:</b> 0 ~ 9999999999.
<b>TTL</b>	1. A Must fill setting 2. 1 to 255 range	Specify <b>TTL</b> hop-count value for this GRE tunnel. <b>Value Range:</b> 1 ~ 255.
<b>Keep alive</b>	1. Unchecked by	Check the <b>Enable</b> box to enable Keep alive function.

## 4G IIoT Gateway

	default 2. 5s is set by default	Select Ping IP to keep live and enter the IP address to ping. Enter the ping time interval in seconds. <b>Value Range: 5 ~ 999 seconds.</b>
<b>Remote Subnet</b>	A Must fill setting	Specify the remote subnet for this GRE tunnel. The Remote Subnet format must be IP address/netmask (e.g. 10.0.0.2/24). It is for the Intranet of GRE server peer. So, at GRE client peer, the packets whose destination is in the dedicated subnet will be transferred via the GRE tunnel. Others will be transferred based on current routing policy of the security gateway at GRE client peer.  If you entered 0.0.0.0/0 in the Remote Subnet field, it will be treated as a default gateway setting for the GRE client peer, all packets, including the Internet accessing of GRE client peer, will go through the established GRE tunnel. That means the remote GRE server peer controls the flow of any packets from the GRE client peer. Certainly, those packets come through the GRE tunnel.
<b>DMVPN Spoke</b>	Unchecked by default	Specify whether the gateway will support DMVPN Spoke for this GRE tunnel. Check Enable box to enable DMVPN Spoke.
<b>IPSec Pre-shared Key</b>	A Must fill setting	Enter a DMVPN spoke authentication Pre-shared Key (8~32 characters). Note: Pre-shared Key is available only when DMVPN Spoke is enabled.
<b>IPSec NAT Traversal</b>	Unchecked by default	Check <b>Enable</b> box to enable NAT-Traversal. Note: IPSec NAT Traversal will not be available when DMVPN is not enabled.
<b>IPSec Encapsulation Mode</b>	Unchecked by default	Specify IPSec Encapsulation Mode from the dropdown box. There are <b>Transport mode</b> and <b>Tunnel mode</b> supported. Note: IPSec Encapsulation Mode will not be available when DMVPN is not enabled.
<b>Tunnel</b>	Unchecked by default	Check <b>Enable</b> box to enable this GRE tunnel.
<b>Save</b>	N/A	Click <b>Save</b> button to save the settings.
<b>Undo</b>	N/A	Click <b>Undo</b> button to cancel the settings.
<b>Back</b>	N/A	Click <b>Back</b> button to return to the previous page.

# 4G IIoT Gateway

## 5.2 Firewall

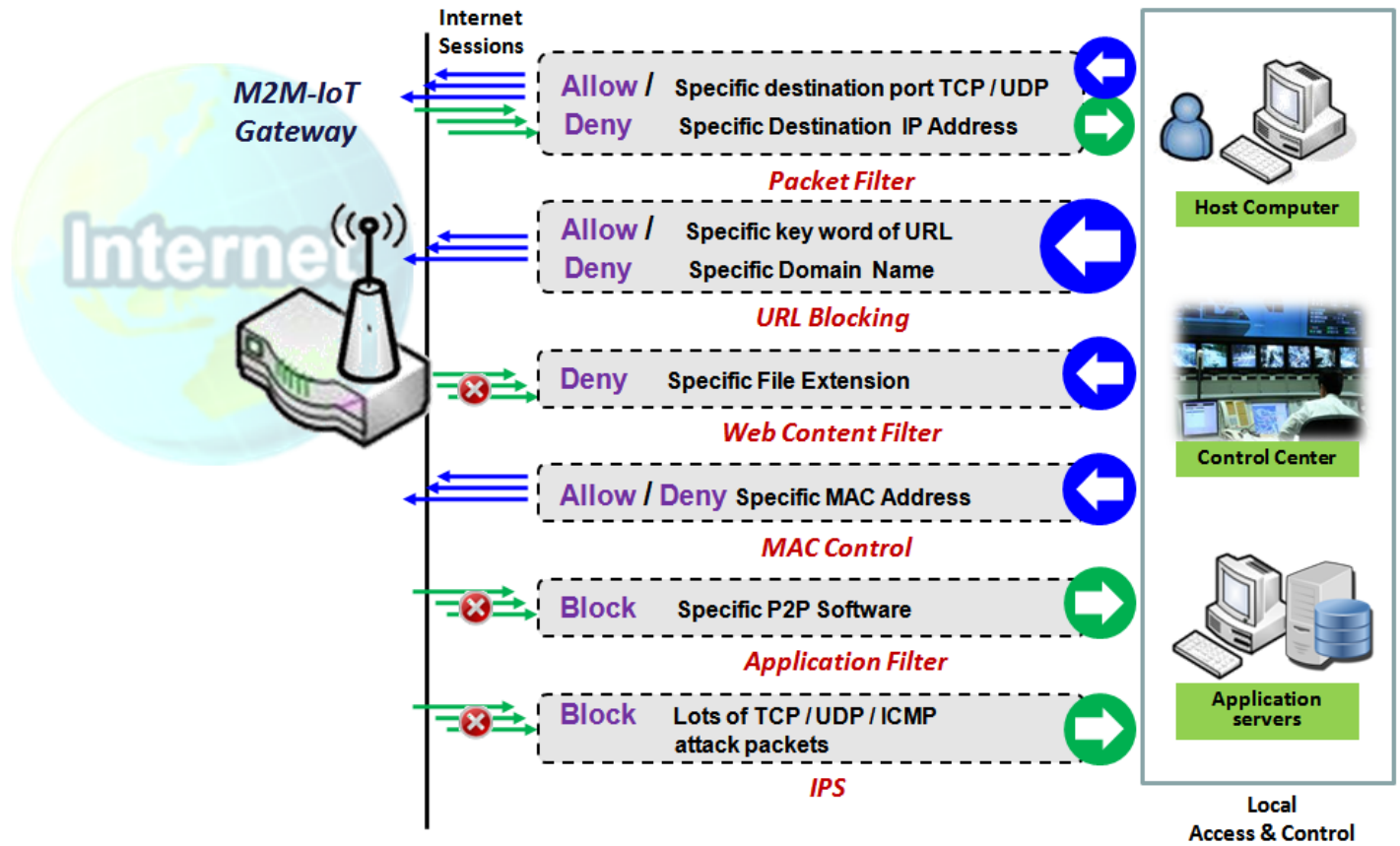

The firewall functions include Packet Filter, URL Blocking, Content Filter, MAC Control, Application Filter, IPS and some firewall options. The supported function can be different for the purchased gateway.

### 5.2.1 Packet Filter

Configuration [ Help ]											
Item	Setting										
▶ Packet Filters	<input checked="" type="checkbox"/> Enable										
▶ Black List / White List	Deny those match the following rules. ▼										
▶ Log Alert	<input type="checkbox"/> Log Alert										

  

Packet Filter List												
ID	Rule Name	From Interface	To Interface	Source IP	Destination IP	Source MAC	Protocol	Source Port	Destination Port	Time Schedule	Enable	Actions
<input type="button" value="Add"/> <input type="button" value="Delete"/>												

# 4G IIoT Gateway

"Packet Filter" function can let you define some filtering rules for incoming and outgoing packets. So the gateway can control what packets are allowed or blocked to pass through it. A packet filter rule should indicate from and to which interface the packet enters and leaves the gateway, the source and destination IP addresses, and destination service port type and port number. In addition, the time schedule to which the rule will be active.

## Packet Filter with White List Scenario

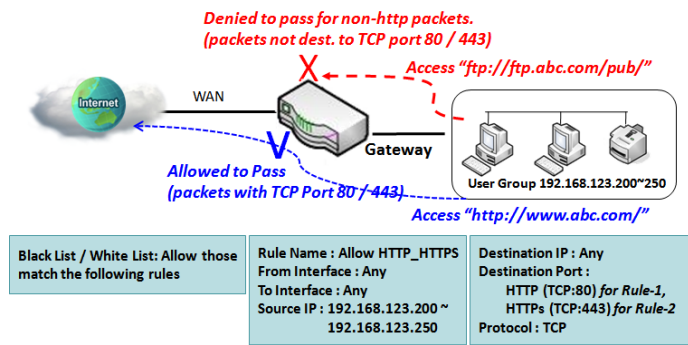

As shown in the diagram, specify "Packet Filter Rule List" as white list (Allow those match the following rules) and define the rules. Rule-1 is to allow HTTP packets to pass, and Rule-2 is to allow HTTPS packets to pass.

Under such configuration, the gateway will allow only HTTP and HTTPS packets, issued from the IP range 192.168.0.200 to 250, which are targeted to TCP port 80 or 443 to pass the WAN interface.

## Packet Filter Setting

Go to **Security > Firewall > Packet Filter** Tab.

The packet filter setting allows user to create and customize packet filter policies to allow or reject specific inbound/outbound packets through the router based on their office setting.

## Enable Packet Filter

Configuration [ Help ]	
Item	Setting
▶ Packet Filters	<input type="checkbox"/> Enable
▶ Black List / White List	Deny those match the following rules. ▼
▶ Log Alert	<input type="checkbox"/> Log Alert

### Configuration Window

Item Name	Value setting	Description
Packet Filter	The box is unchecked by	Check the <b>Enable</b> box to activate Packet Filter function

# 4G IIoT Gateway

	default	
Black List / White List	Deny those match the following rules is set by default	When <b>Deny those match the following rules</b> is selected, as the name suggest, packets specified in the rules will be blocked –black listed. In contrast, with <b>Allow those match the following rules</b> , you can specifically white list the packets to pass and the rest will be blocked.
Log Alert	The box is unchecked by default	Check the <b>Enable</b> box to activate Event Log.
Save	N/A	Click <b>Save</b> to save the settings
Undo	N/A	Click <b>Undo</b> to cancel the settings

## Create/Edit Packet Filter Rules

The gateway allows you to customize your packet filtering rules. It supports up to a maximum of 20 filter rule sets.

Packet Filter List												
ID	Rule Name	From Interface	To Interface	Source IP	Destination IP	Source MAC	Protocol	Source Port	Destination Port	Time Schedule	Enable	Actions

When **Add** button is applied, **Packet Filter Rule Configuration** screen will appear.

Packet Filter Rule Configuration	
Item	Setting
▶ Rule Name	<input type="text" value="Rule1"/>
▶ From Interface	<input type="text" value="Any"/>
▶ To Interface	<input type="text" value="Any"/>
▶ Source IP	<input type="text" value="Any"/>
▶ Destination IP	<input type="text" value="Any"/>
▶ Source MAC	<input type="text" value="Any"/>
▶ Protocol	<input type="text" value="Any(0)"/>
▶ Source Port	<input type="text" value="User-defined Service"/> <input type="text"/> - <input type="text"/>
▶ Destination Port	<input type="text" value="User-defined Service"/> <input type="text"/> - <input type="text"/>
▶ Time Schedule	<input type="text" value="(0) Always"/>
▶ Rule	<input type="checkbox"/> Enable

Packet Filter Rule Configuration		
Item Name	Value setting	Description
Rule Name	1. String format can be	Enter a packet filter rule name. Enter a name that is easy for you to remember.

# 4G IloT Gateway

	<p>any text</p> <p>2. A Must filled setting</p>	<p><b>Value Range:</b> 1 ~ 30 characters.</p>
From Interface	<p>1. A Must filled setting</p> <p><b>2. By default Any is selected</b></p>	<p>Define the selected interface to be the packet-entering interface of the router. If the packets to be filtered are coming from <b>LAN to WAN</b> then select LAN for this field. Or <b>VLAN-1 to WAN</b> then select <b>VLAN-1</b> for this field. Other examples are VLAN-1 to VLAN-2. VLAN-1 to WAN.</p> <p>Select <b>Any</b> to filter packets coming into the router from any interfaces. Please note that two identical interfaces are not accepted by the router. e.g., VLAN-1 to VLAN-1.</p>
To Interface	<p>1. A Must filled setting</p> <p>2. By default Any is selected</p>	<p>Define the selected interface to be the packet-leaving interface of the router. If the packets to be filtered are entering from <b>LAN to WAN</b> then select <b>WAN</b> for this field. Or <b>VLAN-1 to WAN</b> then select <b>WAN</b> for this field. Other examples are VLAN-1 to VLAN-2. VLAN-1 to WAN.</p> <p>Select <b>Any</b> to filter packets leaving the router from any interfaces. Please note that two identical interfaces are not accepted by the router. e.g., VLAN-1 to VLAN-1.</p>
Source IP	<p>1. A Must filled setting</p> <p>2. By default Any is selected</p>	<p>This field is to specify the <b>Source IP address</b>.</p> <p>Select <b>Any</b> to filter packets coming from any IP addresses.</p> <p>Select <b>Specific IP Address</b> to filter packets coming from an IP address.</p> <p>Select <b>IP Range</b> to filter packets coming from a specified range of IP address.</p> <p>Select <b>IP Address-based Group</b> to filter packets coming from a pre-defined group. Note: group must be pre-defined before this option become available. Refer to <b>Object Definition &gt; Grouping &gt; Host grouping</b>. You may also access to create a group by the <b>Add Rule</b> shortcut button.</p>
Destination IP	<p>1. A Must filled setting</p> <p>2. By default Any is selected</p>	<p>This field is to specify the <b>Destination IP address</b>.</p> <p>Select <b>Any</b> to filter packets that are entering to any IP addresses.</p> <p>Select <b>Specific IP Address</b> to filter packets entering to an IP address entered in this field.</p> <p>Select <b>IP Range</b> to filter packets entering to a specified range of IP address entered in this field.</p> <p>Select <b>IP Address-based Group</b> to filter packets entering to a pre-defined group selected. Note: group must be pre-defined before this selection become available. Refer to <b>Object Definition &gt; Grouping &gt; Host grouping</b>. You may also access to create a group by the <b>Add Rule</b> shortcut button. Setting done through the <b>Add Rule</b> button will also appear in the <b>Host grouping</b> setting screen.</p>
Source MAC	<p>1. A Must filled setting</p> <p>2. By default Any is selected</p>	<p>This field is to specify the <b>Source MAC address</b>.</p> <p>Select <b>Any</b> to filter packets coming from any MAC addresses.</p> <p>Select <b>Specific MAC Address</b> to filter packets coming from a MAC address.</p> <p>Select <b>MAC Address-based Group</b> to filter packets coming from a pre-defined group selected. Note: group must be pre-defined before this selection become available. Refer to <b>Object Definition &gt; Grouping &gt; Host grouping</b>. You may also access to create a group by the <b>Add Rule</b> shortcut button.</p>
Protocol	<p>1. A Must filled setting</p> <p>2. By default Any(0) is selected</p>	<p>For <b>Protocol</b>, select <b>Any</b> to filter any protocol packets</p> <p>Then for <b>Source Port</b>, select a predefined port dropdown box when <b>Well-known Service</b> is selected, otherwise select <b>User-defined Service</b> and specify a port range.</p>

# 4G IIoT Gateway

		<p>Then for <b>Destination Port</b>, select a predefined port dropdown box when <b>Well-known Service</b> is selected, otherwise select <b>User-defined Service</b> and specify a port range.</p> <p><b>Value Range:</b> 1 ~ 65535 for Source Port, Destination Port.</p>
		<p>For <b>Protocol</b>, select <b>ICMPv4</b> to filter ICMPv4 packets</p>
		<p>For <b>Protocol</b>, select <b>TCP</b> to filter <b>TCP</b> packets</p> <p>Then for <b>Source Port</b>, select a predefined port dropdown box when <b>Well-known Service</b> is selected, otherwise select <b>User-defined Service</b> and specify a port range.</p> <p>Then for <b>Destination Port</b>, select a predefined port dropdown box when <b>Well-known Service</b> is selected, otherwise select <b>User-defined Service</b> and specify a port range.</p> <p><b>Value Range:</b> 1 ~ 65535 for Source Port, Destination Port.</p>
		<p>For <b>Protocol</b>, select <b>UDP</b> to filter <b>UDP</b> packets</p> <p>Then for <b>Source Port</b>, select a predefined port dropdown box when <b>Well-known Service</b> is selected, otherwise select <b>User-defined Service</b> and specify a port range.</p> <p>Then for <b>Destination Port</b>, select a predefined port dropdown box when <b>Well-known Service</b> is selected, otherwise select <b>User-defined Service</b> and specify a port range.</p> <p><b>Value Range:</b> 1 ~ 65535 for Source Port, Destination Port.</p>
		<p>For <b>Protocol</b>, select <b>GRE</b> to filter <b>GRE</b> packets</p>
		<p>For <b>Protocol</b>, select <b>ESP</b> to filter <b>ESP</b> packets</p>
		<p>For <b>Protocol</b>, select <b>SCTP</b> to filter <b>SCTP</b> packets</p>
		<p>For <b>Protocol</b>, select <b>User-defined</b> to filter packets with specified port number.</p> <p>Then enter a port number in <b>Protocol Number</b> box.</p>
Time Schedule	A Must filled setting	<p>Apply <b>Time Schedule</b> to this rule, otherwise leave it as Always.</p> <p>If the dropdown list is empty ensure <b>Time Schedule</b> is pre-configured. Refer to <b>Object Definition &gt; Scheduling &gt; Configuration</b> tab.</p>
Rule	The box is unchecked by default.	<p>Click <b>Enable</b> box to activate this rule then save the settings.</p>
Save	N/A	<p>Click <b>Save</b> to save the settings</p>
Undo	N/A	<p>Click <b>Undo</b> to cancel the settings</p>
Back	N/A	<p>When the <b>Back</b> button is clicked the screen will return to the Packet Filter Configuration page.</p>

# 4G IIoT Gateway

## 5.2.2 MAC Control

Configuration <span style="float: right;">[ Help ]</span>	
Item	Setting
▶ MAC Control	<input checked="" type="checkbox"/> Enable
▶ Black List / White List	Deny MAC Address Below. ▼
▶ Log Alert	<input type="checkbox"/> Enable
▶ Known MAC from LAN PC List	192.168.1.100(James-P45V) ▼ <input type="button" value="Copy to"/>

MAC Control Rule List <input type="button" value="Add"/> <input type="button" value="Delete"/>					
ID	Rule Name	MAC Address	Time Schedule Rule	Enable	Actions

"MAC Control" function allows you to assign the accessibility to the gateway for different users based on device's MAC address. When the administrator wants to reject the traffics from some client hosts with specific MAC addresses, he can use the "MAC Control" function to reject with the black list configuration.

### MAC Control with Black List Scenario

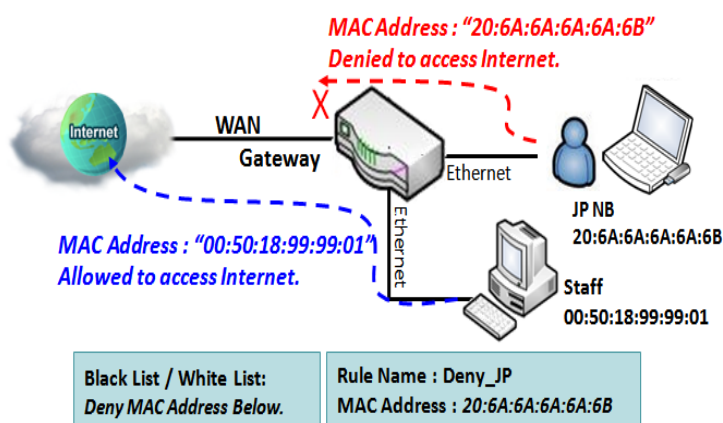

As shown in the diagram, enable the MAC control function and specify the "MAC Control Rule List" is a black list, and configure one MAC control rule for the gateway to deny the connection request from the "JP NB" with its own MAC address 20:6A:6A:6A:6A:6B.

System will block the connecting from the "JP NB" to the gateway but allow others.

# 4G IIoT Gateway

## MAC Control Setting

Go to **Security > Firewall > MAC Control** Tab.

The MAC control setting allows user to create and customize MAC address policies to allow or reject packets with specific source MAC address.

### Enable MAC Control

Configuration <span style="float: right;">[ Help ]</span>	
Item	Setting
▶ MAC Control	<input type="checkbox"/> Enable
▶ Black List / White List	Deny MAC Address Below. ▼
▶ Log Alert	<input type="checkbox"/> Enable
▶ Known MAC from LAN PC List	192.168.123.100(James-P45V) ▼ <input type="button" value="Copy to"/>

Configuration Window		
Item	Value setting	Description
<b>MAC Control</b>	The box is unchecked by default	Check the <b>Enable</b> box to activate the MAC filter function
<b>Black List / White List</b>	Deny MAC Address Below is set by default	When <b>Deny MAC Address Below</b> is selected, as the name suggest, packets specified in the rules will be blocked –black listed. In contrast, with <b>Allow MAC Address Below</b> , you can specifically white list the packets to pass and the rest will be blocked.
<b>Log Alert</b>	The box is unchecked by default	Check the <b>Enable</b> box to activate to activate Event Log.
<b>Known MAC from LAN PC List</b>	N/A	Select a MAC Address from LAN Client List. Click the <b>Copy to</b> to copy the selected <b>MAC Address</b> to the filter rule.
<b>Save</b>	N/A	Click <b>Save</b> to save the settings
<b>Undo</b>	N/A	Click <b>Undo</b> to cancel the settings

# 4G IIoT Gateway

## Create/Edit MAC Control Rules

The gateway supports up to a maximum of 20 filter rule sets. Ensure that the MAC Control is enabled before we can create control rules.

MAC Control Rule List <input type="button" value="Add"/> <input type="button" value="Delete"/>					
ID	Rule Name	MAC Address	Time Schedule Rule	Enable	Actions

When **Add** button is applied, **Filter Rule Configuration** screen will appear.

MAC Control Rule Configuration			
Rule Name	MAC Address (Use : to Compose)	Time Schedule	Enable
<input type="text" value="Rule1"/>	<input type="text"/>	<input type="text" value="(0) Always"/>	<input type="checkbox"/>
<input type="button" value="Save"/>			

MAC Control Rule Configuration		
Item	Value setting	Description
<b>Rule Name</b>	1. String format can be any text 2. A Must fill setting	Enter a MAC Control rule name. Enter a name that is easy for you to remember.
<b>MAC Address (Use: to Compose)</b>	1. MAC Address string Format 2. A Must fill setting	Specify the <b>Source MAC Address</b> to filter rule.
<b>Time Schedule</b>	A Must fill setting	Apply <b>Time Schedule</b> to this rule; otherwise leave it as <b>(0) Always</b> . If the dropdown list is empty, ensure <b>Time Schedule</b> is pre-configured. Refer to <b>Object Definition &gt; Scheduling &gt; Configuration tab</b>
<b>Enable</b>	The box is unchecked by default.	Click <b>Enable</b> box to activate this rule, and then save the settings.
<b>Save</b>	N/A	Click <b>Save</b> to save the settings
<b>Undo</b>	N/A	Click <b>Undo</b> to cancel the settings
<b>Back</b>	N/A	Click <b>Back</b> to return to the MAC Control Configuration page.

# 4G IIoT Gateway

## 5.2.3 IPS

Configuration [ Help ]	
Item	Setting
▶ IPS	<input type="checkbox"/> Enable
▶ Log Alert	<input type="checkbox"/> Enable

  

Intrusion Prevention	
Item	Setting
▶ SYN Flood Defense	<input type="checkbox"/> Enable <input type="text" value="300"/> Packets/second (10~10000)
▶ UDP Flood Defense	<input type="checkbox"/> Enable <input type="text" value="300"/> Packets/second (10~10000)
▶ ICMP Flood Defense	<input type="checkbox"/> Enable <input type="text" value="300"/> Packets/second (10~10000)
▶ Port Scan Detection	<input type="checkbox"/> Enable <input type="text" value="200"/> Packets/second (10~10000)

To provide application servers in the Internet, administrator may need to open specific ports for the services. However, there are some risks to always open service ports in the Internet. In order to avoid such attack risks, it is important to enable IPS functions.

Intrusion Prevention System (IPS) is network security appliances that monitor network and/or system activities for malicious activity. The main functions of IPS are to identify malicious activity, log information about this activity, attempt to block/stop it and report it. You can enable the IPS function and check the listed intrusion activities when needed. You can also enable the log alerting so that system will record Intrusion events when corresponding intrusions are detected.

### IPS Scenario

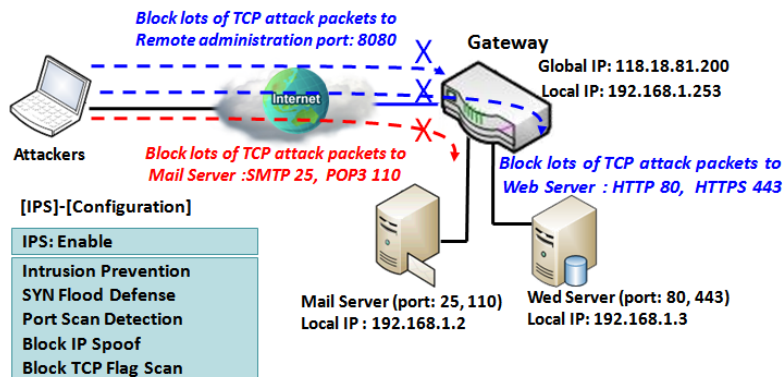

As shown in the diagram, the gateway serves as an E-mail server, Web Server and also provides TCP port 8080 for remote administration. So, remote users or unknown users can request those services from Internet. With IPS enabled, the gateway can detect incoming attack packets, including the TCP ports (25, 80, 110, 443 and 8080) with services. It will block the attack packets and let the normal access to pass through the gateway

# 4G IIoT Gateway

## IPS Setting

Go to **Security > Firewall > IPS** Tab.

The Intrusion Prevention System (IPS) setting allows user to customize intrusion prevention rules to prevent malicious packets.

### Enable IPS Firewall

Configuration <span style="float: right;">[ Help ]</span>	
Item	Setting
▶ IPS	<input type="checkbox"/> Enable
▶ Log Alert	<input type="checkbox"/> Enable

Configuration Window		
Item	Value setting	Description
<b>IPS</b>	The box is unchecked by default	Check the <b>Enable</b> box to activate IPS function
<b>Log Alert</b>	The box is unchecked by default	Check the <b>Enable</b> box to activate to activate Event Log.
<b>Save</b>	N/A	Click <b>Save</b> to save the settings
<b>Undo</b>	N/A	Click <b>Undo</b> to cancel the settings

### Setup Intrusion Prevention Rules

The router allows you to select intrusion prevention rules you may want to enable. Ensure that the IPS is enabled before we can enable the defense function.

# 4G IIoT Gateway

Intrusion Prevention	
Item	Setting
▶ SYN Flood Defense	<input type="checkbox"/> Enable <input type="text" value="300"/> Packets/second (10~10000)
▶ UDP Flood Defense	<input type="checkbox"/> Enable <input type="text" value="300"/> Packets/second (10~10000)
▶ ICMP Flood Defense	<input type="checkbox"/> Enable <input type="text" value="300"/> Packets/second (10~10000)
▶ Port Scan Detection	<input type="checkbox"/> Enable <input type="text" value="200"/> Packets/second (10~10000)
▶ Block Land Attack	<input type="checkbox"/> Enable
▶ Block Ping of Death	<input type="checkbox"/> Enable
▶ Block IP Spoof	<input type="checkbox"/> Enable
▶ Block TCP Flag Scan	<input type="checkbox"/> Enable
▶ Block Smurf	<input type="checkbox"/> Enable
▶ Block Traceroute	<input type="checkbox"/> Enable
▶ Block Fraggle Attack	<input type="checkbox"/> Enable
▶ ARP Spoofing Defence	<input type="checkbox"/> Enable <input type="text" value="300"/> Packets/second (10~10000)

## Setup Intrusion Prevention Rules

Item Name	Value setting	Description
<b>SYN Flood Defense</b>	1. A Must filled setting	Click <b>Enable</b> box to activate this intrusion prevention rule and enter the traffic threshold in this field.
<b>UDP Flood Defense</b>	2. The box is unchecked by default.	Click <b>Enable</b> box to activate this intrusion prevention rule and enter the traffic threshold in this field.
<b>ICMP Flood Defense</b>	3. Traffic threshold is set to 300 by default 4. The value range can be from 10 to 10000.	Click <b>Enable</b> box to activate this intrusion prevention rule and enter the traffic threshold in this field. <b><u>Value Range: 10 ~ 10000.</u></b>
<b>Port Scan Defection</b>	1. A Must filled setting 2. The box is unchecked by default. 3. Traffic threshold is set to 200 by default 4. The value range can be from 10 to 10000.	Click <b>Enable</b> box to activate this intrusion prevention rule and enter the traffic threshold in this field. <b><u>Value Range: 10 ~ 10000.</u></b>
<b>Block Land Attack</b> <b>Block Ping of Death</b> <b>Block IP Spoof</b> <b>Block TCP Flag Scan</b> <b>Block Smurf</b>	The box is unchecked by default.	Click <b>Enable</b> box to activate this intrusion prevention rule.

# 4G IIoT Gateway

---

<b>Block Traceroute</b> <b>Block Fraggle Attack</b>		
<b>ARP Spoofing Defence</b>	<ol style="list-style-type: none"><li>1. A Must filled setting</li><li>2. The box is unchecked by default.</li><li>3. Traffic threshold is set to 300 by default</li><li>4. The value range can be from 10 to 10000.</li></ol>	Click <b>Enable</b> box to activate this intrusion prevention rule and enter the traffic threshold in this field. <b><u>Value Range: 10 ~ 10000.</u></b>
<b>Save</b>	NA	Click <b>Save</b> to save the settings
<b>Undo</b>	NA	Click <b>Undo</b> to cancel the settings

# 4G IIoT Gateway

## 5.2.4 Options

Firewall Options <span style="float: right;">[ Help ]</span>	
Item	Setting
▶ Stealth Mode	<input type="checkbox"/> Enable
▶ SPI	<input checked="" type="checkbox"/> Enable
▶ Discard Ping from WAN	<input type="checkbox"/> Enable

Remote Administrator Host Definition							
ID	Interface	Protocol	IP	Subnet Mask	Service Port	Enable	Action
1	All WAN	HTTP	Any IP	N/A	80	<input type="checkbox"/>	<input type="button" value="Edit"/>
2	All WAN	HTTP	Any IP	N/A	80	<input type="checkbox"/>	<input type="button" value="Edit"/>
3	All WAN	HTTP	Any IP	N/A	80	<input type="checkbox"/>	<input type="button" value="Edit"/>
4	All WAN	HTTP	Any IP	N/A	80	<input type="checkbox"/>	<input type="button" value="Edit"/>
5	All WAN	HTTP	Any IP	N/A	80	<input type="checkbox"/>	<input type="button" value="Edit"/>

There are some additional useful firewall options in this page.

“Stealth Mode” lets gateway not to respond to port scans from the WAN so that makes it less susceptible to discovery and attacks on the Internet. “SPI” enables gateway to record the packet information like IP address, port address, ACK, SEQ number and so on while they pass through the gateway, and the gateway checks every incoming packet to detect if this packet is valid.

“Discard Ping from WAN” makes any host on the WAN side can’t ping this gateway. And finally, “Remote Administrator Hosts” enables you to perform administration task from a remote host. If this feature is enabled, only specified IP address(es) can perform remote administration.

# 4G IIoT Gateway

## Enable SPI Scenario

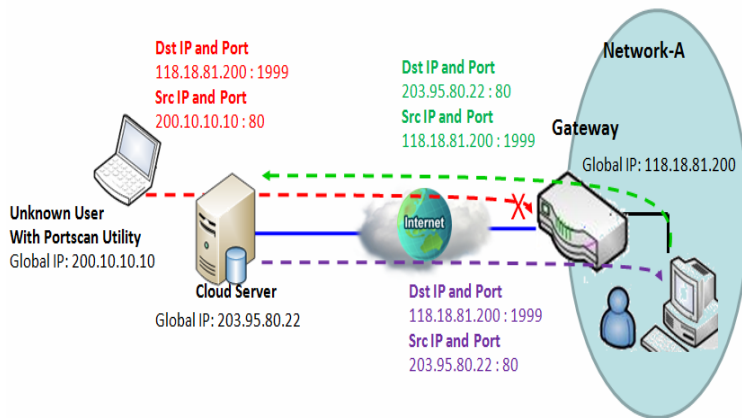

As shown in the diagram, Gateway has the IP address of 118.18.81.200 for WAN interface and 192.168.1.253 for LAN interface. It serves as a NAT gateway. Users in Network-A initiate to access cloud server through the gateway. Sometimes, unknown users will simulate the packets but use different source IP to masquerade. With the SPI feature been enabled at the gateway, it will block such packets from unknown users.

## Discard Ping from WAN & Remote Administrator Hosts Scenario

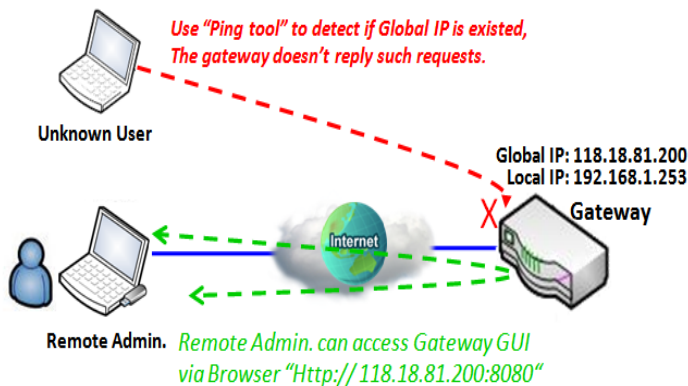

“Discard Ping from WAN” makes any host on the WAN side can't ping this gateway reply any ICMP packets. Enable the Discard Ping from WAN function to prevent security leak when local users surf the internet.

Remote administrator knows the gateway's global IP, and he can access the Gateway GUI via TCP port 8080.

## Firewall Options Setting

Go to **Security > Firewall > Options** Tab.

The firewall options setting allows network administrator to modify the behavior of the firewall and to enable Remote Router Access Control.

## Enable Firewall Options

# 4G IIoT Gateway

Firewall Options <span style="float: right;">[ Help ]</span>	
Item	Setting
▶ Stealth Mode	<input type="checkbox"/> Enable
▶ SPI	<input checked="" type="checkbox"/> Enable
▶ Discard Ping from WAN	<input type="checkbox"/> Enable

Firewall Options		
Item	Value setting	Description
<b>Stealth Mode</b>	The box is unchecked by default	Check the <b>Enable</b> box to activate the Stealth Mode function
<b>SPI</b>	The box is checked by default	Check the <b>Enable</b> box to activate the SPI function
<b>Discard Ping from WAN</b>	The box is unchecked by default	Check the <b>Enable</b> box to activate the Discard Ping from WAN function

## Define Remote Administrator Host

The router allows network administrator to manage router remotely. The network administrator can assign specific IP address and service port to allow accessing the router.

Remote Administrator Host Definition							
ID	Interface	Protocol	IP	Subnet Mask	Service Port	Enable	Action
1	All WAN	HTTP	Any IP	N/A	80	<input type="checkbox"/>	Edit
2	All WAN	HTTP	Any IP	N/A	80	<input type="checkbox"/>	Edit
3	All WAN	HTTP	Any IP	N/A	80	<input type="checkbox"/>	Edit
4	All WAN	HTTP	Any IP	N/A	80	<input type="checkbox"/>	Edit
5	All WAN	HTTP	Any IP	N/A	80	<input type="checkbox"/>	Edit

Remote Administrator Host Definition		
Item	Value setting	Description
<b>Protocol</b>	HTTP is set by default	Select <b>HTTP</b> or <b>HTTPS</b> method for router access.
<b>IP</b>	A Must filled setting	This field is to specify the remote host to assign access right for remote access. Select <b>Any IP</b> to allow any remote hosts Select <b>Specific IP</b> to allow the remote host coming from a specific subnet. An IP address entered in this field and a selected <b>Subnet Mask</b> to compose the subnet.

## 4G IIoT Gateway

---

<b>Service Port</b>	1. 80 for HTTP by default 2. 443 for HTTPS by default	This field is to specify a Service Port to HTTP or HTTPS connection. <b><i>Value Range: 1 ~ 65535.</i></b>
<b>Enabling the rule</b>	The box is unchecked by default.	Click <b>Enable</b> box to activate this rule.
<b>Save</b>	N/A	Click <b>Enable</b> box to activate this rule then save the settings.
<b>Undo</b>	N/A	Click <b>Undo</b> to cancel the settings

## Chapter 6 Administration

### 6.1 Configure & Manage

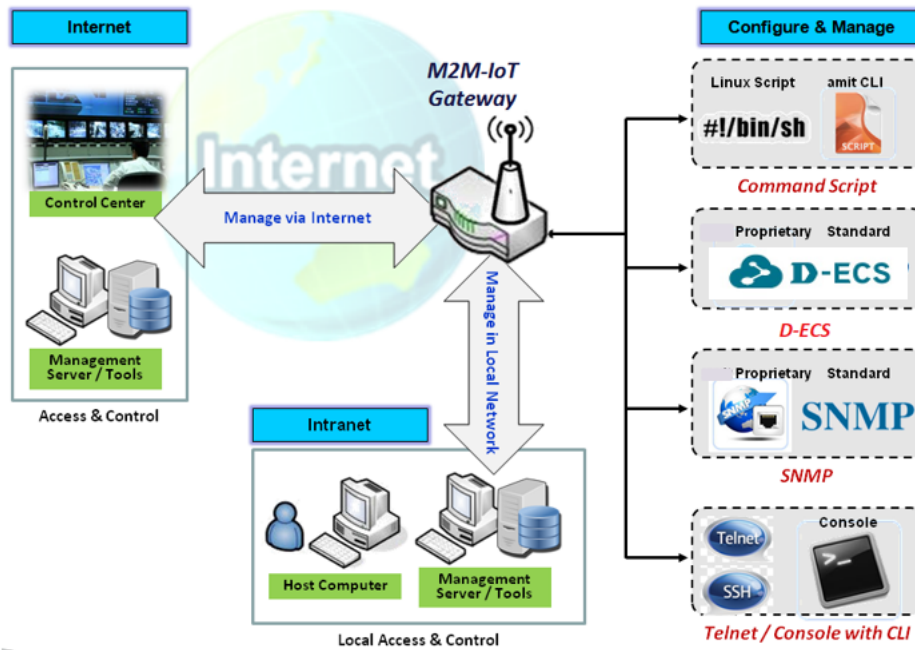

Configure & Manage refers to enterprise-wide administration of distributed systems including (and commonly in practice) computer systems. Centralized management has a time and effort trade-off that is related to the size of the company, the expertise of the IT staff, and the amount of technology being used. This device supports many system management protocols, such as Command Script, SNMP, and Telnet with CLI. You can setup those configurations in the "Configure & Manage" section.

# 4G IIoT Gateway

## 6.1.1 Command Script

Command script configuration is the application that allows administrator to setup the pre-defined configuration in plain text style and apply configuration on startup.

Go to **Administration > Command Script > Configuration Tab**.

### Enable Command Script Configuration

Configuration	
Item	Setting
▶ Configuration	<input type="checkbox"/> Enable
▶ Backup Script	Via Web UI
▶ Upload Script	Via Web UI
▶ Script Name	<input type="text"/>
▶ Version	<input type="text"/>
▶ Description	<div style="border: 1px solid #ccc; height: 40px; width: 100%;"></div>
▶ Update time	

Configuration Item	Value setting	Description
<b>Configuration</b>	The box is unchecked by default	Check the <b>Enable</b> box to activate the Command Script function.
<b>Backup Script</b>	N/A	Click the <b>Via Web UI</b> or <b>Via Storage</b> button to backup the existed command script in a .txt file. You can specify the script file name in <b>Script Name</b> below.
<b>Upload Script</b>	N/A	Click the <b>Via Web UI</b> or <b>Via Storage</b> button to Upload the existed command script from a specified .txt file.
<b>Script Name</b>	1.An Optional setting 2.Any valid file name	Specify a script file name for script backup, or display the selected upload script file name. <b>Value Range: 0 ~ 32 characters.</b>
<b>Version</b>	1.An Optional setting 2.Any string	Specify the version number for the applied Command script. <b>Value Range: 0 ~ 32 characters.</b>
<b>Description</b>	1.An Optional setting 2.Any string	Enter a short description for the applied Command script.
<b>Update time</b>	N/A	It records the upload time for last commad script upload.

# 4G IIoT Gateway

## Edit/Backup Plain Text Command Script

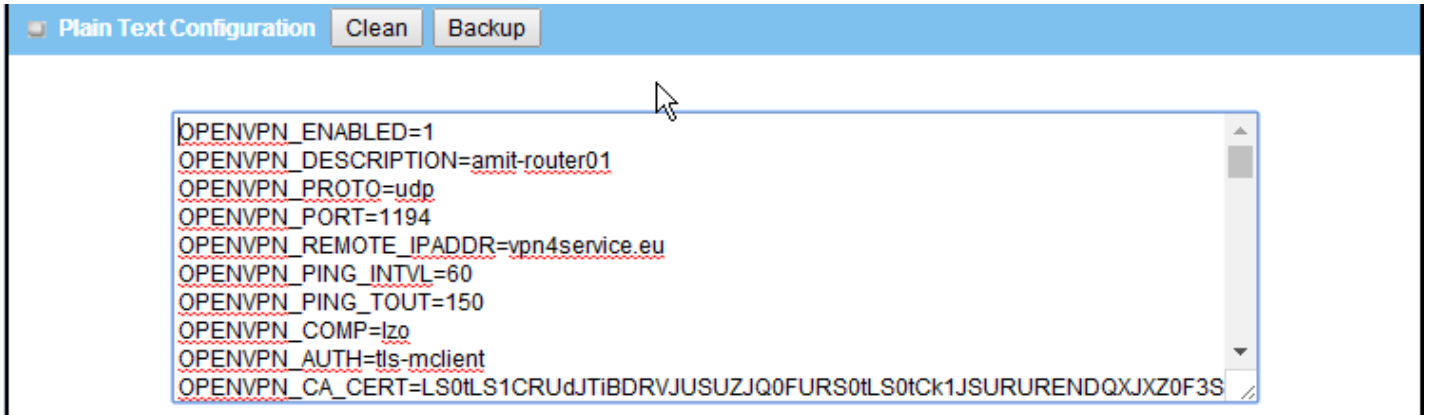

You can edit the plain text configuration settings in the configuration screen as above.

Plain Text Configuration		
Item	Value setting	Description
Clean	NA	Clean text area. (You should click <b>Save</b> button to further clean the configuration already saved in the system.)
Backup	NA	Backup and download configuration.
Save	NA	Save configuration

The supported plain text configuration items are shown in the following list. For the settings that can be executed with standard Linux commands, you can put them in a script file, and apply to the system configure with **STARTUP** command. For those configurations without corresponding Linux command set to configure, you can configure them with proprietary command set.

Configuration Content		
Key	Value setting	Description
<b>OPENVPN_ENABLED</b>	1 : enable 0 : disable	Enable or disable OpenVPN Client function.
<b>OPENVPN_DESCRIPTION</b>	A Must filled Setting	Specify the tunnel name for the OpenVPN Client connection.
<b>OPENVPN_PROTO</b>	udp tcp	Define the <b>Protocol</b> for the OpenVPN Client. <ul style="list-style-type: none"><li>• Select <b>TCP</b> or <b>TCP /UDP</b> -&gt;The OpenVPN will use TCP protocol, and <b>Port</b> will be set as 443 automatically.</li><li>• Select <b>UDP</b> -&gt; The OpenVPN will use UDP protocol, and <b>Port</b> will be set as 1194 automatically.</li></ul>
<b>OPENVPN_PORT</b>	A Must filled Setting	Specify the <b>Port</b> for the OpenVPN Client to use.
<b>OPENVPN_REMOTE_IPADDR</b>	IP or FQDN	Specify the <b>Remote IP/FQDN</b> of the peer OpenVPN Server for this OpenVPN Client tunnel. Fill in the IP address or FQDN.
<b>OPENVPN_PING_INTVL</b>	seconds	Specify the time interval for OpenVPN keep-alive checking.
<b>OPENVPN_PING_TOUT</b>	seconds	Specify the timeout value for OpenVPN Client keep-alive checking.
<b>OPENVPN_COMP</b>	Adaptive	Specify the <b>LZO Compression</b> algorithm for OpenVPN client.
<b>OPENVPN_AUTH</b>	Static Key/TLS	Specify the authorization mode for the OpenVPN tunnel.

# 4G IIoT Gateway

		<ul style="list-style-type: none"> <li>• <b>TLS</b> -&gt;The OpenVPN will use TLS authorization mode, and the following items <b>CA Cert.</b>, <b>Client Cert.</b> and <b>Client Key</b> need to specify as well.</li> </ul>
<b>OPENVPN_CA_CERT</b>	A Must filled Setting	Specify the Trusted CA certificate for the OpenVPN client. It will go through Base64 Conversion.
<b>OPENVPN_LOCAL_CERT</b>	A Must filled Setting	Specify the local certificate for OpenVPN client. It will go through Base64 Conversion.
<b>OPENVPN_LOCAL_KEY</b>	A Must filled Setting	Specify the local key for the OpenVPN client. It will go through Base64 Conversion.
<b>OPENVPN_EXTRA_OPTS</b>	Options	Specify the extra options setting for the OpenVPN client.
<b>IP_ADDR1</b>	Ip	Ethernet LAN IP
<b>IP_NETM1</b>	Net mask	Ethernet LAN MASK
<b>PPP_MONITORING</b>	1 : enable 0 : disable	When the Network Monitoring feature is enabled, the router will use DNS Query or ICMP to periodically check Internet connection – connected or disconnected.
<b>PPP_PING</b>	0 : DNS Query 1 : ICMP Query	With <b>DNS Query</b> , the system checks the connection by sending DNS Query packets to the destination specified in PPP_PING_IPADDR. With <b>ICMP Query</b> , the system will check connection by sending ICMP request packets to the destination specified in PPP_PING_IPADDR.
<b>PPP_PING_IPADDR</b>	IP	Specify an IP address as the target for sending DNS query/ICMP request.
<b>PPP_PING_INTVL</b>	seconds	Specify the time interval for between two DNS Query or ICMP checking packets.
<b>STARTUP</b>	Script file	For the configurations that can be configured with standard Linux commands, you can put them in a script file, and apply the script file with STARTUP command. For example, STARTUP=#!/bin/sh STARTUP=echo "startup done" > /tmp/demo

## Plain Text System Configuration with Telnet

In addition to the web-style plain text configuration as mentioned above, the gateway system also allow the configuration via Telnet CLI. Administrator can use the proprietary telnet command “**txtConfig**” and related action items to perform the plain system configuration.

The command format is: `txtConfig (action) [option]`

Action	Option	Description
<b>clone</b>	<i>Output file</i>	Duplicate the configuration content from database and stored as a configuration file. (ex: <code>txtConfig clone /tmp/config</code> ) The contents in the configuration file are the same as the plain text commands mentioned above. This action is exactly the same as performing the “Backup” plain text configuration.
<b>commit</b>	a existing file	Commit the configuration content to database. (ex: <code>txtConfig commit /tmp/config</code> )
<b>enable</b>	NA	Enable plain text system config.

## 4G IIoT Gateway

---

		(ex: <i>txtConfig enable</i> )
<b>disable</b>	<i>NA</i>	Disable plain text system config. (ex: <i>txtConfig disable</i> )
<b>run_immediately</b>	<i>NA</i>	Apply the configuration content that has been committed in database. (ex: <i>txtConfig run_immediately</i> )
<b>run_immediately</b>	a existing file	Assign a configuration file to apply. (ex: <i>txtConfig run_immediately /tmp/config</i> )

# 4G IIoT Gateway

## 6.1.2 Device Management: D-ECS remote management

D-ECS is a cloud management platform that allows you to manage 4G/5G devices, including DOM-530-TSO anytime, anywhere. In order for the D-ECS system to communicate with individual devices, device registration must be done with device configuration on each device.

To Enable Remote D-ECS Service:

1. Register the device to D-ECS by configuring the relevant settings in the device management page (go to **Configure & Manage > Device Management**) as shown below:

Item	Setting
Device Management	Select Enable to allow management by D-ECS
Input Local Service URL	Input the management service URL: <a href="https://portal.decs.dlink.com/ACS/tr069">https://portal.decs.dlink.com/ACS/tr069</a>
Input Local Server IP STUN Traffic	Input the server address for processing STUN traffic: portal.decs.dlink.com

**Note:** The service URL and Server IP STUN Traffic should be modified accordingly depending on the deployment architecture of the D-ECS system.

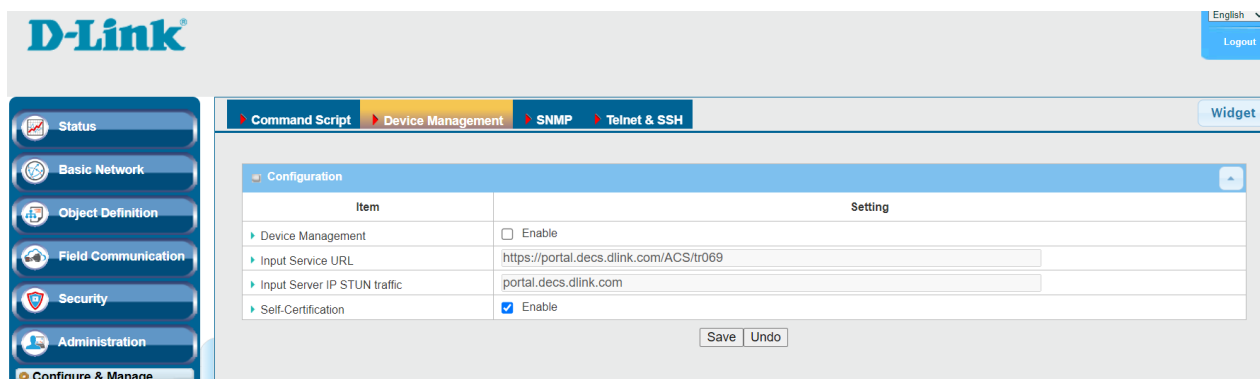

2. log in to the D-ECS Management Interface by typing the URL in your browser's address field: <https://portal.decs.dlink.com/login>.

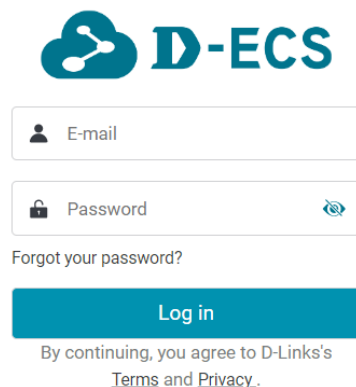

# 4G IIoT Gateway

Note that the URL varies depending on the deployment architecture of the D-ECS system (i.e. on-premises or cloud version).

3. Log in using your ID and password.
4. The Dashboard displays.

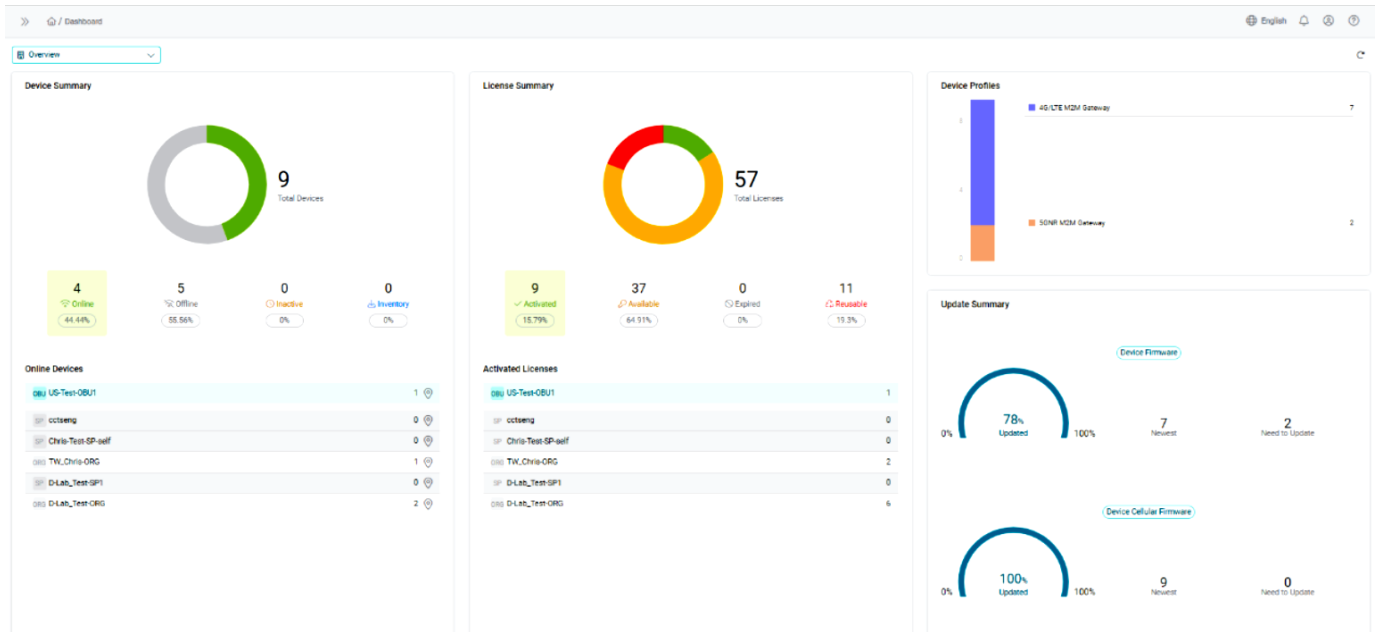

# 4G IIoT Gateway

## 6.1.3 SNMP

In brief, SNMP, the Simple Network Management Protocol, is a protocol designed to give a user the capability to remotely manage a computer network by polling and setting terminal values and monitoring network events.

In typical SNMP uses, one or more administrative computers, called managers, have the task of monitoring or managing a group of hosts or devices on a computer network. Each managed system executes, at all times, a software component called an agent which reports information via SNMP to the manager.

SNMP agents expose management data on the managed systems as variables. The protocol also permits active management tasks, such as modifying and applying a new configuration through remote modification of these variables. The variables accessible via SNMP are organized in hierarchies. These hierarchies, and other metadata (such as type and description of the variable), are described by Management Information Bases (MIBs).

The device supports several public MIBs and one private MIB for the SNMP agent. The supported MIBs are as follow: MIB-II (RFC 1213, Include IPv6), IF-MIB, IP-MIB, TCP-MIB, UDP-MIB, SMIv1 and SMIv2, SNMPv2-TM and SNMPv2-MIB, and AMIB (a Proprietary MIB)

### SNMP Management Scenario

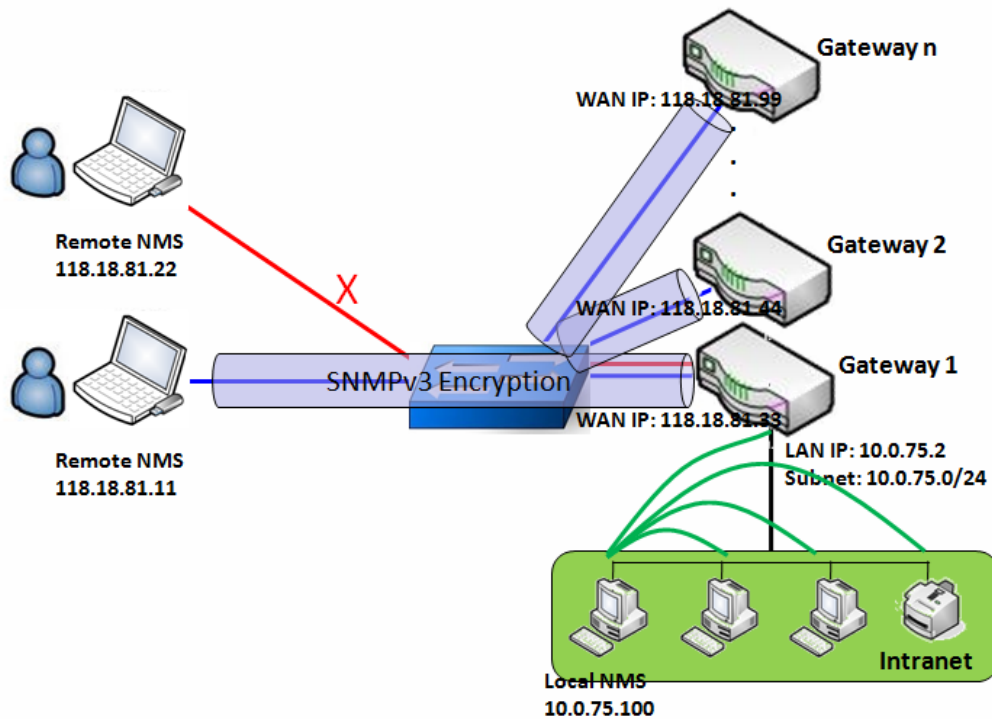

#### Scenario Application Timing

There are two application scenarios of SNMP Network Management Systems (NMS). Local NMS is in

## 4G IIoT Gateway

the Intranet and manage all devices that support SNMP protocol in the Intranet. Another one is the Remote NMS to manage some devices whose WAN interfaces are connected together by using a switch or a router with UDP forwarding. If you want to manage some devices and they all have supported SNMP protocol, use either one application scenario, especially the management of devices in the Intranet. In managing devices in the Internet.

### Scenario Description

The NMS server can monitor and configure the managed devices by using SNMP protocol, and those devices are located at where UDP packets can reach from NMS.

The managed devices report urgent trap events to the NMS servers.

Use SNMPv3 version of protocol can protected the transmitting of SNMP commands and responses.

The remote NMS with privilege IP address can manage the devices, but other remote NMS can't.

### Parameter Setup Example

Following tables list the parameter configuration as an example for the Gateway 1 in above diagram with "SNMP" enabling at LAN and WAN interfaces.

Use default value for those parameters that are not mentioned in the tables.

Configuration Path	[SNMP]-[Configuration]
SNMP Enable	■ LAN ■ WAN
Supported Versions	■ v1 ■ v2c ■ v3
Get / Set Community	ReadCommunity / WriteCommunity
Trap Event Receiver 1	118.18.81.11
WAN Access IP Address	118.18.81.11

Configuration Path	[SNMP]-[User Privacy Definition]		
ID	1	2	3
User Name	UserName1	UserName2	UserName3
Password	Password1	Password2	Disable
Authentication	MD5	SHA-1	Disable
Encryption	DES	Disable	Disable
Privacy Mode	authPriv	authNoPriv	noAuthNoPriv
Privacy Key	12345678	Disable	Disable
Authority	Read/Write	Read	Read
Enable	■ Enable	■ Enable	■ Enable

### Scenario Operation Procedure

In above diagram, the NMS server can manage multiple devices in the Intranet or a UDP-reachable network. The "Gateway 1" is one of the managed devices, and it has the IP address of 10.0.75.2 for LAN interface and 118.18.81.33 for WAN-1 interface. It serves as a NAT router.

## 4G IIoT Gateway

---

At first stage, the NMS manager prepares related information for all managed devices and records them in the NMS system. Then NMS system gets the status of all managed devices by using SNMP get commands.

When the manager wants to configure the managed devices, the NMS system allows him to do that by using SNMP set commands. The "UserName1" account is used if the manager uses SNMPv3 protocol for configuring the "Gateway 1". Only the "UserName1" account can let the "Gateway 1" accept the configuration from the NMS since the authority of the account is "Read/Write".

Once a managed device has an urgent event to send, the device will issue a trap to the Trap Event Receivers. The NMS itself could be one among them.

If you want to secure the transmitted SNMP commands and responses between the NMS and the managed devices, use SNMPv3 version of protocol.

The remote NMS without privilege IP address can't manage the "Gateway 1", since "Gateway 1" allows only the NMS with privilege IP address can manage it via its WAN interface.

# 4G IIoT Gateway

## SNMP Setting

Go to **Administration > Configure & Manage > SNMP** tab.

The SNMP allows user to configure SNMP relevant setting which includes interface, version, access control and trap receiver.

### Enable SNMP

Configuration	
Item	Setting
SNMP Enable	<input checked="" type="checkbox"/> LAN <input type="checkbox"/> WAN
WAN Interface	All WANs
Supported Versions	<input checked="" type="checkbox"/> v1 <input checked="" type="checkbox"/> v2c <input type="checkbox"/> v3
SNMP Port	161

SNMP Item	Value setting	Description
<b>SNMP Enable</b>	1.The boxes are checked by default	Select the interface for the SNMP and enable SNMP functions. When Check the <b>LAN</b> box, it will activate SNMP functions and you can access SNMP from LAN side; When Check the <b>WAN</b> box, it will activate SNMP functions and you can access SNMP from WAN side.
<b>WAN Interface</b>	1.A Must filled setting 2. <b>ALL WANs is selected by default</b>	Specify the WAN interface that a remote SNMP host can access to the device. By default, <b>All WANs</b> is selected, and there is no limitation for the WAN interface.
<b>Supported Versions</b>	1.A Must filled setting 2.The boxes are unchecked by default	Select the version for the SNMP When Check the <b>v1</b> box. It means you can access SNMP by version 1. When Check the <b>v2c</b> box. It means you can access SNMP by version 2c. When Check the <b>v3</b> box. It means you can access SNMP by version 3.
<b>Remote Access IP</b>	1. String format: any IPv4 address 2. It is an optional item.	Specify the <b>Remote Access IP</b> for WAN. Select <b>Specific IP Address</b> , and fill in a certain IP address. It means only this IP address can access SNMP from LAN/WAN side. Select <b>IP Range</b> , and fill in a range of IP addresses. It means the IP address within specified range can access SNMP from LAN/WAN side.  If you left it as blank, it means any IP address can access SNMP from WAN side.
<b>SNMP Port</b>	1. String format: any port number 2. The default SNMP port is <b>161</b> . 3. A Must filled setting	Specify the <b>SNMP Port</b> . You can fill in any port number. But you must ensure the port number is not to be used. <b>Value Range: 1 ~ 65535.</b>

# 4G IIoT Gateway

<b>Save</b>	N/A	Click <b>Save</b> to save the settings
<b>Undo</b>	N/A	Click <b>Undo</b> to cancel the settings

## Create/Edit Multiple Community

The SNMP allows you to custom your access control for version 1 and version 2 user. The router supports up to a maximum of 10 community sets.

Multiple Community List <input type="button" value="Add"/> <input type="button" value="Delete"/>			
ID	Community	Enable	Actions

When **Add** button is applied, **Multiple Community Rule Configuration** screen will appear.

Multiple Community Rule Configuration	
Item	Setting
▶ Community	Read Only ▾ <input type="text"/>
▶ Enable	<input checked="" type="checkbox"/> Enable

Multiple Community Rule Configuration		
Item	Value setting	Description
<b>Community</b>	<ol style="list-style-type: none"> <li>Read Only is selected by default</li> <li>A Must filled setting</li> <li>String format: any text</li> </ol>	Specify this version 1 or version v2c user’s community that will be allowed Read Only (GET and GETNEXT) or Read-Write (GET, GETNEXT and SET) access respectively. The maximum length of the community is 32.
<b>Enable</b>	1.The box is checked by default	Click Enable to enable this version 1 or version v2c user.
<b>Save</b>	N/A	Click the <b>Save</b> button to save the configuration. But it does not apply to SNMP functions. When you return to the SNMP main page. It will show “Click on save button to apply your changes” remind user to click main page Save button.
<b>Undo</b>	N/A	Click the <b>Undo</b> button to cancel the settings.
<b>Back</b>	N/A	Click the <b>Back</b> button to return to last page.

## Create/Edit User Privacy

The SNMP allows you to custom your access control for version 3 user. The router supports up to a maximum

# 4G IIoT Gateway

of 128 User Privacy sets.

User Privacy List <input type="button" value="Add"/> <input type="button" value="Delete"/>										
ID	User Name	Password	Authentication	Encryption	Privacy Mode	Privacy Key	Authority	OID Filter Prefix	Enable	Actions

When **Add** button is applied, **User Privacy Rule Configuration** screen will appear.

User Privacy Rule Configuration	
Item	Setting
▶ User Name	<input type="text"/>
▶ Password	<input type="password"/>
▶ Authentication	None ▼
▶ Encryption	None ▼
▶ Privacy Mode	noAuthNoPriv ▼
▶ Privacy Key	<input type="password"/>
▶ Authority	Read ▼
▶ OID Filter Prefix	1 <input type="text"/>
▶ Enable	<input checked="" type="checkbox"/> Enable

User Privacy Rule Configuration		
Item	Value setting	Description
<b>User Name</b>	1. A Must filled setting 2. String format: any text	Specify the <b>User Name</b> for this version 3 user. <b>Value Range:</b> 1 ~ 32 characters.
<b>Password</b>	1. String format: any text	When your <b>Privacy Mode</b> is <b>authNoPriv</b> or <b>authPriv</b> , you must specify the <b>Password</b> for this version 3 user. <b>Value Range:</b> 8 ~ 64 characters.
<b>Authentication</b>	1. <b>None</b> is selected by default	When your <b>Privacy Mode</b> is <b>authNoPriv</b> or <b>authPriv</b> , you must specify the <b>Authentication</b> types for this version 3 user. Selected the authentication types <b>MD5/ SHA-1</b> to use.
<b>Encryption</b>	1. <b>None</b> is selected by default	When your <b>Privacy Mode</b> is <b>authPriv</b> , you must specify the <b>Encryption</b> protocols for this version 3 user. Selected the encryption protocols <b>DES / AES</b> to use.
<b>Privacy Mode</b>	1. <b>noAuthNoPriv</b> is selected by default	Specify the <b>Privacy Mode</b> for this version 3 user. Selected the <b>noAuthNoPriv</b> . You do not use any authentication types and encryption protocols. Selected the <b>authNoPriv</b> . You must specify the <b>Authentication</b> and <b>Password</b> .

# 4G IIoT Gateway

		Selected the <b>authPriv</b> . You must specify the Authentication, Password, Encryption and Privacy Key.
<b>Privacy Key</b>	1. String format: any text	When your <b>Privacy Mode</b> is <b>authPriv</b> , you must specify the <b>Privacy Key (8 ~ 64 characters)</b> for this version 3 user.
<b>Authority</b>	1. <b>Read</b> is selected by default	Specify this version 3 user's <b>Authority</b> that will be allowed <b>Read Only</b> (GET and GETNEXT) or <b>Read-Write</b> (GET, GETNEXT and SET) access respectively.
<b>OID Filter Prefix</b>	1. The default value is 1 2. A Must filled setting 3. String format: any legal OID	The <b>OID Filter Prefix</b> restricts access for this version 3 user to the sub-tree rooted at the given OID. <b>Value Range: 1 ~2080768.</b>
<b>Enable</b>	1.The box is checked by default	Click <b>Enable</b> to enable this version 3 user.
<b>Save</b>	N/A	Click the <b>Save</b> button to save the configuration. But it does not apply to SNMP functions. When you return to the SNMP main page. It will show "Click on save button to apply your changes" remind user to click main page <b>Save</b> button.
<b>Undo</b>	N/A	Click the <b>Undo</b> button to cancel the settings
<b>Back</b>	N/A	Click the <b>Back</b> button to return the last page.

## Create/Edit Trap Event Receiver

The SNMP allows you to custom your trap event receiver. The router supports up to a maximum of 4 Trap Event Receiver sets.

Trap Event Receiver List												
ID	Server IP	Server Port	SNMP Version	Community Name	User Name	Password	Privacy Mode	Authentication	Encryption	Privacy Key	Enable	Actions

When **Add** button is applied, **Trap Event Receiver Rule Configuration** screen will appear. The default SNMP Version is v1. The configuration screen will provide the version 1 must filled items.

Trap Event Receiver Rule Configuration	
Item	Setting
▶ Server IP	<input type="text"/> (IP Address/FQDN)
▶ Server Port	<input type="text" value="162"/>
▶ SNMP Version	<input type="text" value="v1"/>
▶ Community Name	<input type="text"/>
▶ Enable	<input checked="" type="checkbox"/> Enable

# 4G IIoT Gateway

When you selected v2c, the configuration screen is exactly the same as that of v1, except the version.

When you selected v3, the configuration screen will provide more setting items for the version 3 Trap.

Trap Event Receiver Rule Configuration	
Item	Setting
▶ Server IP	<input type="text"/> (IP Address/FQDN)
▶ Server Port	<input type="text" value="162"/>
▶ SNMP Version	<input type="text" value="v3"/>
▶ Community Name	<input type="text"/>
▶ User Name	<input type="text"/>
▶ Password	<input type="text"/>
▶ Privacy Mode	<input type="text" value="noAuthNoPriv"/>
▶ Authentication	<input type="text" value="None"/>
▶ Encryption	<input type="text" value="None"/>
▶ Privacy Key	<input type="text"/>
▶ Enable	<input checked="" type="checkbox"/> Enable

Trap Event Receiver Rule Configuration		
Item	Value setting	Description
<b>Server IP</b>	<ol style="list-style-type: none"> <li>1. A Must filled setting</li> <li>2. String format: any IPv4 address or FQDN</li> </ol>	Specify the trap <b>Server IP</b> or <b>FQDN</b> . The DUT will send trap to the server IP/FQDN.
<b>Server Port</b>	<ol style="list-style-type: none"> <li>1. String format: any port number</li> <li>2. The default SNMP trap port is 162</li> <li>3. A Must filled setting</li> </ol>	Specify the trap <b>Server Port</b> . You can fill in any port number. But you must ensure the port number is not to be used. <i>Value Range: 1 ~ 65535.</i>
<b>SNMP Version</b>	<ol style="list-style-type: none"> <li>1. <b>v1</b> is selected by default</li> </ol>	Select the version for the trap Selected the <b>v1</b> . The configuration screen will provide the version 1 must filled items. Selected the <b>v2c</b> . The configuration screen will provide the version 2c must filled items. Selected the <b>v3</b> . The configuration screen will provide the version 3 must filled items.
<b>Community Name</b>	<ol style="list-style-type: none"> <li>1. A <b>v1</b> and <b>v2c</b> Must filled setting</li> <li>2. String format: any text</li> </ol>	Specify the <b>Community Name</b> for this version 1 or version v2c trap. <i>Value Range: 1 ~ 32 characters.</i>
<b>User Name</b>	<ol style="list-style-type: none"> <li>1. A <b>v3</b> Must filled</li> </ol>	Specify the <b>User Name</b> for this version 3 trap.

# 4G IIoT Gateway

	<ul style="list-style-type: none"> <li>setting</li> <li>2. String format: any text</li> </ul>	<b><i>Value Range:</i></b> 1 ~ 32 characters.
<b>Password</b>	<ul style="list-style-type: none"> <li>1. A <b>v3</b> Must filled setting</li> <li>2. String format: any text</li> </ul>	<p>When your <b>Privacy Mode</b> is <b>authNoPriv</b> or <b>authPriv</b>, you must specify the <b>Password</b> for this version 3 trap.</p> <p><b><i>Value Range:</i></b> 8 ~ 64 characters.</p>
<b>Privacy Mode</b>	<ul style="list-style-type: none"> <li>1. A <b>v3</b> Must filled setting</li> <li>2. <b>noAuthNoPriv</b> is selected by default</li> </ul>	<p>Specify the <b>Privacy Mode</b> for this version 3 trap.</p> <p>Selected the <b>noAuthNoPriv</b>.</p> <p>You do not use any authentication types and encryption protocols.</p> <p>Selected the <b>authNoPriv</b>.</p> <p>You must specify the <b>Authentication</b> and <b>Password</b>.</p> <p>Selected the <b>authPriv</b>.</p> <p>You must specify the Authentication, Password, Encryption and Privacy Key.</p>
<b>Authentication</b>	<ul style="list-style-type: none"> <li>1. A <b>v3</b> Must filled setting</li> <li>2. <b>None</b> is selected by default</li> </ul>	<p>When your <b>Privacy Mode</b> is <b>authNoPriv</b> or <b>authPriv</b>, you must specify the <b>Authentication</b> types for this version 3 trap.</p> <p>Selected the authentication types <b>MD5/ SHA-1</b> to use.</p>
<b>Encryption</b>	<ul style="list-style-type: none"> <li>1. A <b>v3</b> Must filled setting</li> <li>2. <b>None</b> is selected by default</li> </ul>	<p>When your <b>Privacy Mode</b> is <b>authPriv</b>, you must specify the <b>Encryption</b> protocols for this version 3 trap.</p> <p>Selected the encryption protocols <b>DES / AES</b> to use.</p>
<b>Privacy Key</b>	<ul style="list-style-type: none"> <li>1. A <b>v3</b> Must filled setting</li> <li>2. String format: any text</li> </ul>	<p>When your <b>Privacy Mode</b> is <b>authPriv</b>, you must specify the <b>Privacy Key</b> (8 ~ 64 characters) for this version 3 trap.</p>
<b>Enable</b>	<ul style="list-style-type: none"> <li>1. The box is checked by default</li> </ul>	Click <b>Enable</b> to enable this trap receiver.
<b>Save</b>	N/A	Click the <b>Save</b> button to save the configuration. But it does not apply to SNMP functions. When you return to the SNMP main page. It will show “Click on save button to apply your changes” remind user to click main page <b>Save</b> button.
<b>Undo</b>	N/A	Click the <b>Undo</b> button to cancel the settings.
<b>Back</b>	N/A	Click the <b>Back</b> button to return the last page.

## Specify SNMP MIB-2 System

If required, you can also specify the required onformation the the MIB-2 System.

# 4G IIoT Gateway

SNMP MIB-2 System	
Item	Setting
▶ sysContact	<input type="text"/>
▶ sysLocation	<input type="text"/>

SNMP MIB-2 System Configuration		
Item	Value setting	Description
<b>sysContact</b>	1. An Optional filled setting 2. String format: any text	Specify the contact information forMIB-2 system. <b>Value Range:</b> 0 ~ 64 characters.
<b>sysLocation</b>	1. An Optional filled setting 2. String format: any text	Specify the location information forMIB-2 system. <b>Value Range:</b> 0 ~ 64 characters.

## Edit SNMP Options

If you use some particular private MIB, you must fill the enterprise name, number and OID.

Options	
Item	Setting
▶ Enterprise Name	<input type="text" value="Dlink"/>
▶ Enterprise Number	<input type="text" value="171"/>
▶ Enterprise OID	1.3.6.1.4.1. <input type="text" value="171.70.4.9"/>

Options		
Item	Value setting	Description
<b>Enterprise Name</b>	1. The default value is <b>Dlink</b> 2. A Must filled setting 3. String format: any text	Specify the <b>Enterprise Name</b> for the particular private MIB. <b>Value Range:</b> 1 ~ 10 characters, and only string with A~Z, a~z, 0~9, '-', '_'.
<b>Enterprise Number</b>	The default value is 171 (Default Enterprise Number) 2. A Must filled setting 3. String format: any number	Specify the <b>Enterprise Number</b> for the particular private MIB. <b>Value Range:</b> 1 ~2080768.

## 4G IIoT Gateway

---

<b>Enterprise OID</b>	<ol style="list-style-type: none"><li>1. The default value is 1.3.6.1.4.1.171.70.4.9 (Default Enterprise OID)</li><li>2. A Must filled setting</li><li>3. String format: any legal OID</li></ol>	<p>Specify the <b>Enterprise OID</b> for the particular private MIB.</p> <p>The range of the each OID number is 1-2080768.</p> <p>The maximum length of the enterprise OID is 31.</p> <p>The seventh number must be identical with the enterprise number.</p>
<b>Save</b>	N/A	Click the <b>Save</b> button to save the configuration and apply your changes to SNMP functions.
<b>Undo</b>	N/A	Click the <b>Undo</b> button to cancel the settings.

# 4G IIoT Gateway

## 6.1.4 Telnet & SSH

A command-line interface (CLI), also known as command-line user interface, and console user interface are means of interacting with a computer program where the user (or client) issues commands to the program in the form of successive lines of text (command lines). The interface is usually implemented with a command line shell, which is a program that accepts commands as text input and converts commands to appropriate operating system functions. Programs with command-line interfaces are generally easier to automate via scripting. The device supports both Telnet and SSH (Secure Shell) CLI with default service port 23 and 22, respectively.

### Telnet & SSH Scenario

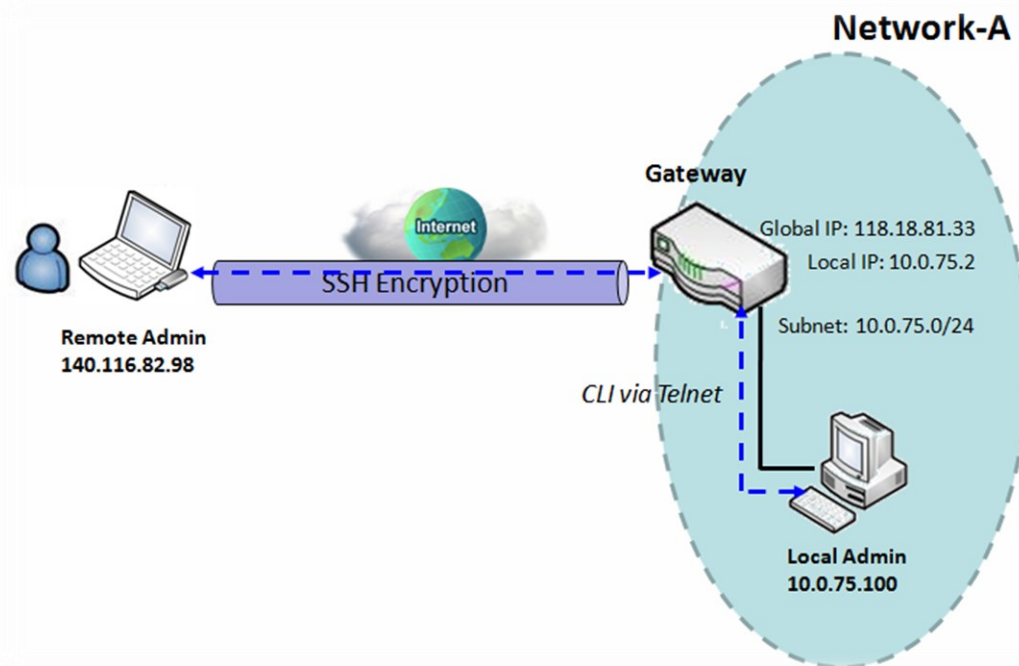

#### Scenario Application Timing

When the administrator of the gateway wants to manage it from remote site in the Intranet or Internet, he may use "Telnet with CLI" function to do that by using "Telnet" or "SSH" utility.

#### Scenario Description

The Local Admin or the Remote Admin can manage the Gateway by using "Telnet" or "SSH" utility with privileged user name and password.

The data packets between the Local Admin and the Gateway or between the Remote Admin and the Gateway can be plain texts or encrypted texts. Suggest they are plain texts in the Intranet for Local Admin to use "Telnet" utility, and encrypted texts in the Internet for Remote Admin to use "SSH" utility.

# 4G IIoT Gateway

---

## Parameter Setup Example

Following table lists the parameter configuration as an example for the Gateway in above diagram with "Telnet with CLI" enabling at LAN and WAN interfaces.

Use default value for those parameters that are not mentioned in the table.

Configuration Path	[Telnet & SSH]-[Configuration]
Telnet	LAN: <input checked="" type="checkbox"/> <b>Enable</b> WAN: <input type="checkbox"/> <b>Enable</b> Service Port: <b>23</b>
SSH	LAN: <input checked="" type="checkbox"/> <b>Enable</b> WAN: <input checked="" type="checkbox"/> <b>Enable</b> Service Port: <b>22</b>

## Scenario Operation Procedure

In above diagram, "Local Admin" or "Remote Admin" can manage the "Gateway" in the Intranet or Internet. The "Gateway" is the gateway of Network-A, and the subnet of its Intranet is 10.0.75.0/24. It has the IP address of 10.0.75.2 for LAN interface and 118.18.81.33 for WAN-1 interface. It serves as a NAT gateway.

The "Local Admin" in the Intranet uses "Telnet" utility with privileged account to login the Gateway.

Or the "Remote Admin" in the Internet uses "SSH" utility with privileged account to login the Gateway.

The administrator of the gateway can control the device as like he is in front of the gateway.

# 4G IIoT Gateway

## Telnet & SSH Setting

Go to **Administration > Configure & Manage > Telnet & SSH** tab.

The Telnet & SSH setting allows administrator to access this device through the traditional Telnet or SSH Telnet program. Before you can telnet (login) to the device, please configure the related settings and password with care. The password management part allows you to set root password for logging telnet and SSH.

Configuration <span>Save</span> <span>Undo</span>	
Item	Setting
▶ Telnet	LAN <input checked="" type="checkbox"/> Enable WAN <input type="checkbox"/> Enable Service Port <input type="text" value="23"/>
▶ SSH	LAN <input checked="" type="checkbox"/> Enable WAN <input type="checkbox"/> Enable Service Port <input type="text" value="22"/>

Configuration		
Item	Value setting	Description
<b>Telnet</b>	1. The LAN Enable box is checked by default. 2. By default <b>Service Port</b> is 23.	Check the <b>Enable</b> box to activate the Telnet function for connecting from LAN or WAN interfaces. You can set which number of <b>Service Port</b> you want to provide for the corresponding service. <b>Value Range: 1 ~65535.</b>
<b>SSH</b>	3. The LAN Enable box is checked by default. 4. By default <b>Service Port</b> is 22.	Check the <b>Enable</b> box to activate the SSH Telnet function for connecting from LAN or WAN interfaces. You can set which number of <b>Service Port</b> you want to provide for the corresponding service. <b>Value Range: 1 ~65535.</b>
<b>Save</b>	N/A	Click <b>Save</b> to save the settings
<b>Undo</b>	N/A	Click <b>Undo</b> to cancel the settings

Password Management <span>Save</span> <span>Undo</span>	
Item	Setting
▶ root	Old Password : <input type="text"/> New Password : <input type="text"/> New Password Confirmation : <input type="text"/>

# 4G IIoT Gateway

---

Configuration		
Item	Value setting	Description
<b>root</b>	1. String: any text but no blank character 2. The default password for telnet is 'wirelessm2m'.	Type old password and specify new password to change root password. <b>Note_1: You are highly recommended to change the default telnet password with yours before the device is deployed.</b> <b>Note_2: If you have trouble for the default password for previous FW version, please check the corresponding User Manual to get the correct one.</b>
<b>Save</b>	N/A	Click <b>Save</b> to save the settings
<b>Undo</b>	N/A	Click <b>Undo</b> to cancel the settings

# 4G IIoT Gateway

## 6.2 System Operation

System Operation allows the network administrator to manage system, settings such as web-based utility access password change, system information, system time, system log, firmware/configuration backup & restore, and reset & reboot.

### 6.2.1 Password & MMI

Go to **Administration > System Operation > Password & MMI** tab.

#### Setup Host Name

Host Name screen allows network administrator to setup / change the host name of the gateway. Click the **Modify** button and provide the new username setting.

Host Name	
Item	Setting
▶ Host Name	<input type="text"/>

Username Configuration		
Item	Value setting	Description
<b>Host Name</b>	1. An Optional setting 2. It is blanked by default	Enter the host name of the gateway.
<b>Save</b>	N/A	Click <b>Save</b> button to save the settings
<b>Undo</b>	N/A	Click <b>Undo</b> button to cancel the settings

#### Change UserName

Username screen allows network administrator to change the web-based MMI login account to access gateway. Click the **Modify** button and provide the new username setting.

Username	
Item	Setting
▶ Username	admin <input type="button" value="Modify"/>
▶ New Username	<input type="text"/>
▶ Password	<input type="text"/>

# 4G IIoT Gateway

Username Configuration		
Item	Value setting	Description
<b>Username</b>	1. The default Username for web-based MMI is 'admin'.	Display the current MMI login account (Username).
<b>New Username</b>	String: any text	Enter new Username to replace the current setting.
<b>Password</b>	String: any text	Enter current password to verify if you have the permission to change the username setting.
<b>Save</b>	N/A	Click <b>Save</b> button to save the settings
<b>Undo</b>	N/A	Click <b>Undo</b> button to cancel the settings

## Change Password

Change password screen allows network administrator to change the web-based MMI login password to access gateway.

Password <span style="float: right;">[ Help ]</span>	
Item	Setting
▶ Old Password	<input type="text"/>
▶ New Password	<input type="text"/>
▶ New Password Confirmation	<input type="text"/>

Password Configuration		
Item	Value setting	Description
<b>Old Password</b>	1. String: any text 2. <b>The default password for web-based MMI is 'admin'.</b>	Enter the current password to enable you unlock to change password.
<b>New Password</b>	String: any text	Enter new password
<b>New Password Confirmation</b>	String: any text	Enter new password again to confirm
<b>Save</b>	N/A	Click <b>Save</b> button to save the settings
<b>Undo</b>	N/A	Click <b>Undo</b> button to cancel the settings

## Change MMI Setting for Accessing

This is the gateway's web-based MMI access which allows administrator to access the gateway for management. The gateway's web-based MMI will automatically logout when the idle time has elapsed. The setting allows administrator to enable automatic logout and set the logout idle time. When the login timeout

# 4G IIoT Gateway

is disabled, the system won't logout the administrator automatically.

MMI <span style="float: right;">[ Help ]</span>	
Item	Setting
▶ Login	Password-Guessing Attack & MAX: <input type="text" value="3"/> (times)
▶ Login Timeout	<input checked="" type="checkbox"/> Enable <input type="text" value="300"/> (seconds)
▶ GUI Access Protocol	<input type="text" value="http/https"/> ▼
▶ HTTPS Certificate Setup	<input checked="" type="radio"/> default <input type="radio"/> Select from Certificate List Certificate: <input type="text"/> Key: <input type="text"/>
▶ HTTP Compression	<input type="checkbox"/> gzip <input type="checkbox"/> deflate
▶ HTTP Binding	<input checked="" type="checkbox"/> DHCP 1
▶ System Boot Mode	<input type="text" value="Normal Mode"/> ▼

MMI Configuration		
Item	Value setting	Description
<b>Login</b>	3 times is set by default	Enter the login trial counting value. <b>Value Range:</b> 3 ~ 10. If someone tried to login the web GUI with incorrect password for more than the counting value, an warning message " <b>Already reaching maximum Password-Guessing times, please wait a few seconds!</b> " will be displayed and ignore the following login trials.
<b>Login Timeout</b>	The Enable box is checked, and 300 is set by default.	Check the Enable box to activate the auto logout function, and specify the maximum idle time as well. <b>Value Range:</b> 30 ~ 65535.
<b>GUI Access Protocol</b>	<b>http/https</b> is selected by default.	Select the protocol that will be used for GUI access. It can be <b>http/https</b> , <b>http only</b> , or <b>https only</b> .
<b>HTTPS Certificate Setup</b>	The <b>default</b> box is selected by default	If the https Access Protocol is selected, the HTTPS Certificate Setup option will be available for further configuration. You can leave it as default or select a expected certificate and key from the drop down list. Refer to <b>Object Definition &gt; Certificate</b> Section for the Certificate configuration.
<b>http Compression</b>	The box is unchecked by default.	Check the box ( <b>gzip</b> , or <b>deflate</b> ) if any compression method is preferred.
<b>http Binding</b>	1. An Optional setting 2. DHCP-1 is checked by default	Select the DHCP Server to bind with http access.
<b>System Boot Mode</b>	<b>Normal Mode</b> is selected	Select the system boot mode that will be adopted to boot up the device.

# 4G IIoT Gateway

---

by default.

**Normal Mode:** It takes longer boot up time, about 200 seconds, with complete firmware image check during the device booting.

**Fast Mode:** It takes shorter boot up time, about 120 seconds, without checking the firmware image during the device booting.

**Quick Mode:** It takes shorter boot up time, about 90 seconds, without checking the firmware image and create the internal database for User/Group/Captive Portal functions.

**Note:** Use **Quick Mode** with care, once selected, the User/Group/Captive Portal function will become non-functional.

<b>Save</b>	N/A	Click <b>Save</b> button to save the settings
<b>Undo</b>	N/A	Click <b>Undo</b> button to cancel the settings

# 4G IIoT Gateway

## 6.2.2 System Information

System Information screen gives network administrator a quick look up on the device information for the purchased gateway.

Go to **Administration > System Operation > System Information** tab.



Item	Setting
▶ Model Name	DOM-530-TSO A1
▶ Device Serial Number	ZZ23A00084
▶ Kernel Version	2.6.36
▶ FW Version	1.00.00
▶ System Time	Fri, 03 May 2024 02:54:48 +0000
▶ Device Up-Time	Oday 0hr 2min 13sec

System Information		
Item	Value Setting	Description
<b>Model Name</b>	N/A	It displays the model name of this product.
<b>Device Serial Number</b>	N/A	It displays the serial number of this product.
<b>Kernel Version</b>	N/A	It displays the Linux kernel version of the product
<b>FW Version</b>	N/A	It displays the firmware version of the product
<b>Memory Usage</b>	N/A	It displays the percentage of device memory utilization.
<b>System Time</b>	N/A	It displays the current system time that you browsed this web page.
<b>Device Up-Time</b>	N/A	It displays the statistics for the device up-time since last boot up.
<b>Refresh</b>	N/A	Click the <b>Refresh</b> button to update the system Information immediately.

# 4G IIoT Gateway

## 6.2.3 System Time

The gateway provides manually setup and auto-synchronized approaches for the administrator to setup the system time for the gateway. The time supported synchronization methods can be Time Server, Manual, PC, Cellular Module, or GPS Signal. Select the method first, and then configure rest settings.

Instead of manually configuring the system time for the gateway, there are two simple and quick solutions for you to set the correct time information and set it as the system time for the gateway.

The first one is “Sync with Timer Server”. Based on your selection of time zone and time server in above time information configuration window, system will communicate with time server by NTP Protocol to get system date and time after you click on the **Synchronize immediately** button.

The second one is “Sync with my PC”. Select the method and the system will synchronize its date and time to the time of the administration PC.

Go to **Administration > System Operation > System Time** tab.

### Synchronize with Time Server

System Time Configuration	
Item	Setting
▶ Synchronization method	Time Server ▼
▶ Time Zone	(GMT+00:00) Greenwich Mean Time: Dublin, Edinburgh, Lisbon, London ▼
▶ Auto-synchronization	Time Server: <input type="text"/> Available Time Servers (RFC-868): Auto ▼
▶ Daylight Saving Time	<input type="checkbox"/> Enable
▶ NTP Service	<input type="checkbox"/> Enable
▶ Synchronize immediately	Active

System Time Information		
Item	Value Setting	Description
<b>Synchronization method</b>	1. A Must-filled item. 2. <b>Time Server</b> is selected by default.	Select the <b>Time Server</b> as the synchronization method for the system time.
<b>Time Zone</b>	1. A Must-filled item. 2. <b>GMT+00 :00</b> is selected by default.	Select a time zone where this device locates.
<b>Auto-synchronization</b>	1. A Must-filled item. 2. Auto is selected by	Enter the IP or FQDN for the NTP time server you expected, or leave it as auto mode so that the available server will be used for time synchronization one by

# 4G IIoT Gateway

	default.	one.
<b>Daylight Saving Time</b>	1. It is an optional item. 2. Un-checked by default	Check the <b>Enable</b> button to activate the daylight saving function. When you enabled this function, you have to specify the start date and end date for the daylight saving time duration.
<b>NTP Service</b>	1. It is an optional item. 2. Un-checked by default	Check the <b>Enable</b> button to activate the NTP Service function. When you enabled this function, the gateway can provide NTP server service for its local connected devices.
<b>Synchronize immediately</b>	N/A	Click the <b>Active</b> button to synchronize the system time with specified time server immediately.
<b>Save</b>	N/A	Click the <b>Save</b> button to save the settings.
<b>Refresh</b>	N/A	Click the <b>Refresh</b> button to update the system time immediately.

Note: Remember to select a correct time zone for the device, otherwise, you will just get the UTC (Coordinated Universal Time) time, not the local time for the device.

## Synchronize with Manually Setting

System Time Configuration

Item	Setting
▶ Synchronization method	Manual ▼
▶ Time Zone	(GMT+00:00) Greenwich Mean Time: Dublin, Edinburgh, Lisbon, London ▼
▶ Daylight Saving Time	<input type="checkbox"/> Enable
▶ Set Date & Time Manually	2018 ▼ / January ▼ / 09 ▼ (Year/Month/Day)
	15 ▼ : 37 ▼ : 58 ▼ (Hour:Minute:Second)
▶ NTP Service	<input type="checkbox"/> Enable

System Time Information		
Item	Value Setting	Description
<b>Synchronization method</b>	1. A Must-filled item. 2. <b>Time Server</b> is selected by default.	Select the <b>Manual</b> as the synchronization method for the system time. It means administrator has to set the Date & Time manually.
<b>Time Zone</b>	1. A Must-filled item. 2. <b>GMT+00 :00</b> is selected by default.	Select a time zone where this device locates.
<b>Daylight Saving Time</b>	1. It is an optional item. 2. Un-checked by default	Check the <b>Enable</b> button to activate the daylight saving function. When you enabled this function, you have to specify the start date and end date for the daylight saving time duration.
<b>Set Date &amp; Time Manually</b>	1. It is an optional item.	Manually set the date (Year/Month/Day) and time (Hour:Minute:Second) as the system time.
<b>NTP Service</b>	1. It is an optional item.	Check the <b>Enable</b> button to activate the NTP Service function.

# 4G IIoT Gateway

	2. Un-checked by default	When you enabled this function, the gateway can provide NTP server service for its local connected devices.
<b>Save</b>	N/A	Click the <b>Save</b> button to save the settings.

## Synchronize with PC

☐
**System Time Configuration**

Item	Setting
▶ Synchronization method	PC ▼
▶ NTP Service	<input type="checkbox"/> Enable
▶ Synchronize immediately	Active

System Time Information		
Item	Value Setting	Description
<b>Synchronization method</b>	1. A Must-filled item. 2. <b>Time Server</b> is selected by default.	Select <b>PC</b> as the synchronization method for the system time to let system synchronize its date and time to the time of the administration PC.
<b>NTP Service</b>	1. It is an optional item. 2. Un-checked by default	Check the <b>Enable</b> button to activate the NTP Service function. When you enabled this function, the gateway can provide NTP server service for its local connected devices.
<b>Synchronize immediately</b>	N/A	Click the <b>Active</b> button to synchronize the system time with specified time server immediately.
<b>Save</b>	N/A	Click the <b>Save</b> button to save the settings.
<b>Refresh</b>	N/A	Click the <b>Refresh</b> button to update the system time immediately.

# 4G IIoT Gateway

## Synchronize with Cellular Time Service

System Time Configuration	
Item	Setting
▶ Synchronization method	Cellular Module ▾
▶ Time Zone	(GMT+00:00) Greenwich Mean Time: Dublin, Edinburgh, Lisbon, London ▾
▶ NTP Service	<input type="checkbox"/> Enable
▶ Synchronize immediately	Active

System Time Information		
Item	Value Setting	Description
<b>Synchronization method</b>	1. A Must-filled item. 2. <b>Time Server</b> is selected by default.	Select <b>Cellular Module</b> as the synchronization method for the system time to let system synchronize its date and time to the time provided from the connected mobile ISP. Note: this option is only available for the product with Cellular WAN interface.
<b>Time Zone</b>	1. A Must-filled item. 2. <b>GMT+00 :00</b> is selected by default.	Select a time zone where this device locates.
<b>NTP Service</b>	1. It is an optional item. 2. Un-checked by default	Check the <b>Enable</b> button to activate the NTP Service function. When you enabled this function, the gateway can provide NTP server service for its local connected devices.
<b>Synchronize immediately</b>	N/A	Click the <b>Active</b> button to synchronize the system time with specified time server immediately.
<b>Save</b>	N/A	Click the <b>Save</b> button to save the settings.
<b>Refresh</b>	N/A	Click the <b>Refresh</b> button to update the system time immediately.

# 4G IIoT Gateway

## Synchronize with GPS Time Service

System Time Configuration	
Item	Setting
▶ Synchronization method	GPS Signal ▾
▶ Time Zone	(GMT+00:00) Greenwich Mean Time: Dublin, Edinburgh, Lisbon, London ▾
▶ NTP Service	<input type="checkbox"/> Enable
▶ Synchronize immediately	Active

System Time Information		
Item	Value Setting	Description
<b>Synchronization method</b>	1. A Must-filled item. 2. <b>Time Server</b> is selected by default.	Select <b>GPS Signal</b> as the synchronization method for the system time to let system synchronize its date and time to the time provided from the GNSS service. Note: this option is only available for the product with GNSS interface.
<b>Time Zone</b>	1. A Must-filled item. 2. <b>GMT+00 :00</b> is selected by default.	Select a time zone where this device locates.
<b>NTP Service</b>	1. It is an optional item. 2. Un-checked by default	Check the <b>Enable</b> button to activate the NTP Service function. When you enabled this function, the gateway can provide NTP server service for its local connected devices.
<b>Synchronize immediately</b>	N/A	Click the <b>Active</b> button to synchronize the system time with specified time server immediately.
<b>Save</b>	N/A	Click the <b>Save</b> button to save the settings.
<b>Refresh</b>	N/A	Click the <b>Refresh</b> button to update the system time immediately.

# 4G IIoT Gateway

## 6.2.4 System Log

System Log screen contains various event log tools facilitating network administrator to perform local event logging and remote reporting.

Go to **Administration > System Operation > System Log** tab.

System Log	
Item	Setting
▶ Web Log Type Category	<input checked="" type="checkbox"/> System <input checked="" type="checkbox"/> Attacks <input checked="" type="checkbox"/> Drop <input checked="" type="checkbox"/> Login message <input type="checkbox"/> Debug
▶ Email Alert	<input type="checkbox"/> Enable Server: --- Option --- ▼ <input type="button" value="Add Object"/> E-mail Addresses: <input type="text"/> Subject: <input type="text"/> Log type Category: <input type="checkbox"/> System <input type="checkbox"/> Attacks <input type="checkbox"/> Drop <input type="checkbox"/> Login message <input type="checkbox"/> Debug
▶ Syslogd	<input type="checkbox"/> Enable                       Server: --- Option --- ▼ <input type="button" value="Add Object"/> Log type Category: <input type="checkbox"/> System <input type="checkbox"/> Attacks <input type="checkbox"/> Drop <input type="checkbox"/> Login message <input type="checkbox"/> Debug
▶ Log to Storage	<input type="checkbox"/> Enable Select Device: Internal ▼ Log file name: syslog Split file: <input type="checkbox"/> Enable                       Size: 200 <input type="text"/> KB ▼ Interval: <input type="checkbox"/> Enable 1440 ( 1 ~ 10080 Minutes) <input type="button" value="Download log file"/> Log type Category: <input type="checkbox"/> System <input type="checkbox"/> Attacks <input type="checkbox"/> Drop <input type="checkbox"/> Login message <input type="checkbox"/> Debug

### View & Email Log History

**View** button is provided for network administrator to view log history on the gateway. **Email Now** button enables administrator to send instant Email for analysis.

View & Email Log History		
Item	Value setting	Description
View button	N/A	Click the <b>View</b> button to view Log History in Web Log List Window.
Email Now button	N/A	Click the <b>Email Now</b> button to send Log History via Email instantly.

# 4G IIoT Gateway

Web Log List	
<a href="#">Previous</a> <a href="#">Next</a> <a href="#">First</a> <a href="#">Last</a> <a href="#">Download</a> <a href="#">Clear</a>	
Time	Log
Dec 2 18:38:23	kernel: klogd started: BusyBox v1.3.2 (2015-10-29 12:52:33 CST)
Dec 2 18:38:33	BEID: BEID STATUS : 0 , STATUS OK!
Dec 2 18:38:40	commander: NETWORK Initialization finished. Result: 0
Dec 2 18:38:40	commander: Initialize MultiWAN
Dec 2 18:38:40	commander: index = 14, failover_index = 14
Dec 2 18:38:40	commander: wantype = 32, wantype index = 99, wan mode = 1, route enable = 1
Dec 2 18:38:40	commander: fo enable = 14, fo stay enable = 0, fo trigger = 1, fo time = 30, fo sequence = 0
Dec 2 18:38:40	commander: wantype = 16, wantype index = 0, wan mode = 2, route enable = 1
Dec 2 18:38:40	commander: fo enable = 14, fo stay enable = 0, fo trigger = 0, fo time = 0, fo sequence = 0
Dec 2 18:38:40	commander: LOAD BALANCE!
Dec 2 18:38:40	commander: ROUTING!
Dec 2 18:38:42	syslog: server_config.pool_check = 1
Dec 2 18:38:42	syslog: start = 192.168.85.100, end = 192.168.85.200, lan_ip = 192.168.85.2, interface=br0, ifindex=0
Dec 2 18:38:42	udhcpd[1413]: udhcpd (v0.9.9-pre) started
Dec 2 18:38:43	syslog: Failure parsing line 13 of /etc/udhcpd_vlan0.conf
Page: 1/8 (Log Number: 109)	
<a href="#">Back</a>	

Web Log List Window		
Item	Value Setting	Description
Time column	N/A	It displays event time stamps
Log column	N/A	It displays Log messages

Web Log List Button Description		
Item	Value setting	Description
Previous	N/A	Click the <b>Previous</b> button to move to the previous page.
Next	N/A	Click the <b>Next</b> button to move to the next page.
First	N/A	Click the <b>First</b> button to jump to the first page.
Last	N/A	Click the <b>Last</b> button to jump to the last page.
Download	N/A	Click the <b>Download</b> button to download log to your PC in tar file format.
Clear	N/A	Click the <b>Clear</b> button to clear all log.
Back	N/A	Click the <b>Back</b> button to return to the previous page.

## Web Log Type Category

Web Log Type Category screen allows network administrator to select the type of events to log and be displayed in the Web Log List Window as described in the previous section. Click on the View button to view Log History in the Web Log List window.

<a href="#">Web Log Type Category</a>	<input checked="" type="checkbox"/> System <input checked="" type="checkbox"/> Attacks <input checked="" type="checkbox"/> Drop <input checked="" type="checkbox"/> Login message <input type="checkbox"/> Debug
---------------------------------------	------------------------------------------------------------------------------------------------------------------------------------------------------------------------------------------------------------------

# 4G IIoT Gateway

Web Log Type Category Setting Window		
Item	Value Setting	Description
System	Checked by default	Check to log system events and to display in the Web Log List window.
Attacks	Checked by default	Check to log attack events and to display in the Web Log List window.
Drop	Checked by default	Check to log packet drop events and to display in the Web Log List window.
Login message	Checked by default	Check to log system login events and to display in the Web Log List window.
Debug	Un-checked by default	Check to log debug events and to display in the Web Log List window.

## Email Alert

Email Alert screen allows network administrator to select the type of event to log and be sent to the destined Email account.

▶ Email Alert

Enable

Server: --- Option --- ▼ Add Object

E-mail Addresses:

Subject:

Log type Category:  System  Attacks  Drop  Login message  Debug

Email Alert Setting Window		
Item	Value Setting	Description
Enable	Un-checked by default	Check <b>Enable</b> box to enable sending event log messages to destined Email account defined in the E-mail Addresses blank space.
Server	N/A	Select one email server from the Server dropdown box to send Email. If none has been available, click the <b>Add Object</b> button to create an outgoing Email server. You may also add an outgoing Email server from Object Definition > External Server > External Server tab.
E-mail address	String : email format	Enter the recipient's Email address. Separate Email addresses with comma ',' or semicolon ';' Enter the Email address in the format of 'myemail@domain.com'
Subject	String : any text	Enter an Email subject that is easy for you to identify on the Email client.
Log type category	Default unchecked	Select the type of events to log and be sent to the designated Email account. Available events are System, Attacks, Drop, Login message, and Debug.

# 4G IIoT Gateway

## Syslogd

Syslogd screen allows network administrator to select the type of event to log and be sent to the designated Syslog server.

▶ Syslogd
  Enable Server: --- Option --- ▾ Add Object  
 Log type Category:  System  Attacks  Drop  Login message  Debug

Syslogd Setting Window		
Item	Value Setting	Description
<b>Enable</b>	Un-checked by default	Check Enable box to activate the Syslogd function, and send event logs to a syslog server
<b>Server</b>	N/A	Select one syslog server from the Server dropdown box to send event log to. If none has been available, click the <b>Add Object</b> button to create a system log server. You may also add an system log server from the Object Definition > External Server > External Server tab.
<b>Log type category</b>	Un-checked by default	Select the type of event to log and be sent to the destined syslog server. Available events are System, Attacks, Drop, Login message, and Debug.

## Log to Storage

Log to Storage screen allows network administrator to select the type of events to log and be stored at an internal or an external storage.

▶ Log to Storage
  Enable  
 Select Device: Internal ▾  
 Log file name: syslog  
 Split file:  Enable Size: 200 KB ▾  
 Interval:  Enable 1440 ( 1 ~ 10080 Minutes)  
Download log file  
 Log type Category:  System  Attacks  Drop  Login message  Debug

Log to Storage Setting Window		
Item	Value Setting	Description
<b>Enable</b>	Un-checked by default	Check to enable sending log to storage.
<b>Select Device</b>	Internal is selected by default	Select internal or external storage.
<b>Log file name</b>	Un-checked by default	Enter log file name to save logs in designated storage.
<b>Split file Enable</b>	Un-checked by default	Check <b>enable</b> box to split file whenever log file reaching the specified limit.
<b>Split file Size</b>	<b>200 KB</b> is set by default	Enter the file size limit for each split log file. <i>Value Range: 10 ~1000.</i>
<b>Interval Enable</b>	Un-checked by default	Check <b>enable</b> box to enable the log interval setting.
<b>Log Interval</b>	<b>1440</b> is set by default	Enter the log interval setting. <i>Value Range: 1 ~10080 Minute.</i>
<b>Log type category</b>	Un-checked by default	Check which type of logs to send: System, Attacks, Drop, Login message, Debug

## 4G IIoT Gateway

---

Log to Storage Item	Button Value setting	Description
Download log file	N/A	Click the <b>Download log file</b> button to download log files to a log.tar file.

# 4G IIoT Gateway

## 6.2.5 Backup & Restore

In the Backup & Restore window, you can upgrade the device firmware when new firmware is available and also backup / restore the device configuration.

In addition to the factory default settings, you can also customize a special configuration setting as a customized default value. With this customized default value, you can reset the device to the expected default setting if needed.

Go to **Administration > System Operation > Backup & Restore** tab.

FW Backup & Restore	
Item	Setting
▶ FW Upgrade	Via Web UI ▼ FW Upgrade
▶ Backup Configuration Settings	Download ▼ Via Web UI
▶ Auto Restore Configuration	<input type="checkbox"/> Enable Save Conf. Clean Conf. Conf. Info.
▶ Self-defined Logo	Download ▼ Via Web UI

FW Backup & Restore		
Item	Value Setting	Description
<b>FW Upgrade</b>	Via Web UI is selected by default	If new firmware is available, click the <b>FW Upgrade</b> button to upgrade the device firmware <b>via Web UI</b> , or <b>Via Storage</b> . After clicking on the “FW Upgrade” command button, you need to specify the file name of new firmware by using “Browse” button, and then click “Upgrade” button to start the FW upgrading process on this device. If you want to upgrade a firmware which is from GPL policy, please check “Accept unofficial firmware”
<b>Backup Configuration Settings</b>	Download is selected by default	You can backup or restore the device configuration settings by clicking the <b>Via Web UI</b> button. <b>Download:</b> for backup the device configuration to a config.bin file. <b>Upload:</b> for restore a designated configuration file to the device. <b>Via Web UI:</b> to retrieve the configuration file via Web GUI.
<b>Auto Restore Configuration</b>	The Enable box is unchecked by default	Click the <b>Enable</b> button to activate the customized default setting function. Once the function is activated, you can save the expected setting as a customized default setting by clicking the <b>Save Conf.</b> button, or clicking the <b>Clean Conf.</b> button to erase the stored customized configuration.

# 4G IIoT Gateway

## 6.2.6 Reboot & Reset

For some special reason or situation, you may need to reboot the gateway or reset the device configuration to its default value. In addition to perform these operations through the Power ON/OFF, or pressing the reset button on the device panel, you can do it through the web GUI too.

Go to **Administration > System Operation > Reboot & Reset** tab.

In the Reboot & Reset window, you can reboot this device by clicking the “Reboot” button, and reset this device to default settings by clicking the “Reset” button.

System Operation	
Item	Setting
▶ Reboot	Now ▼ Reboot
▶ Reset to Default	Reset

System Operation Window		
Item	Value Setting	Description
<b>Reboot</b>	Now is selected by default	Click the <b>Reboot</b> button to reboot the gateway immediately or on a pre-defined time schedule. <b>Now:</b> Reboot immediately <b>Time Schedule:</b> Select a pre-defined auto-reboot time schedule rule to reboot the auto device on a designated tim. To define a time schedule rule, go to <b>Object Definition &gt; Scheduling &gt; Configuration</b> tab.
<b>Reset to Default</b>	N/A	Click the <b>Reset</b> button to reset the device configuration to its default value.

# 4G IIoT Gateway

## 6.3 FTP

The File Transfer Protocol (FTP) is a standard network protocol used to transfer computer files between a client and server on a computer network. FTP is built on a client-server model architecture and uses separate control and data connections between the client and the server. FTP users may authenticate themselves with a clear-text sign-in protocol, normally in the form of a username and password, but can connect anonymously if the server is configured to allow it.

For secure transmission that protects the username and password, and encrypts the content, FTP is often secured with SSL/TLS (FTPS). Besides, SSH File Transfer Protocol (SFTP) is sometimes also used instead, but is technologically different.

This gateway embedded FTP / SFTP server for administrator to download the log files to his computer or database. In the following two sections, you can configure the FTP server and create the user accounts that can login to the server. After login to the FTP server, you can browse the log directory and have the permission to download the stored log files and delete the files you have downloaded to make more storage space for further data logs.

The available log files can be system logs (refer to Administration > System Operation > System Log), Network Packets (refer to Administrator > Diagnostic > Packet Analyzer), Data Log (refer to Field Communication > Data Logging > Log File Management), and GNSS Log (refer to Service > Location Tracking > GNSS). With proper configuration for the various log functions that supported on your purchased product, you can download the log via FTP / SFTP connections.

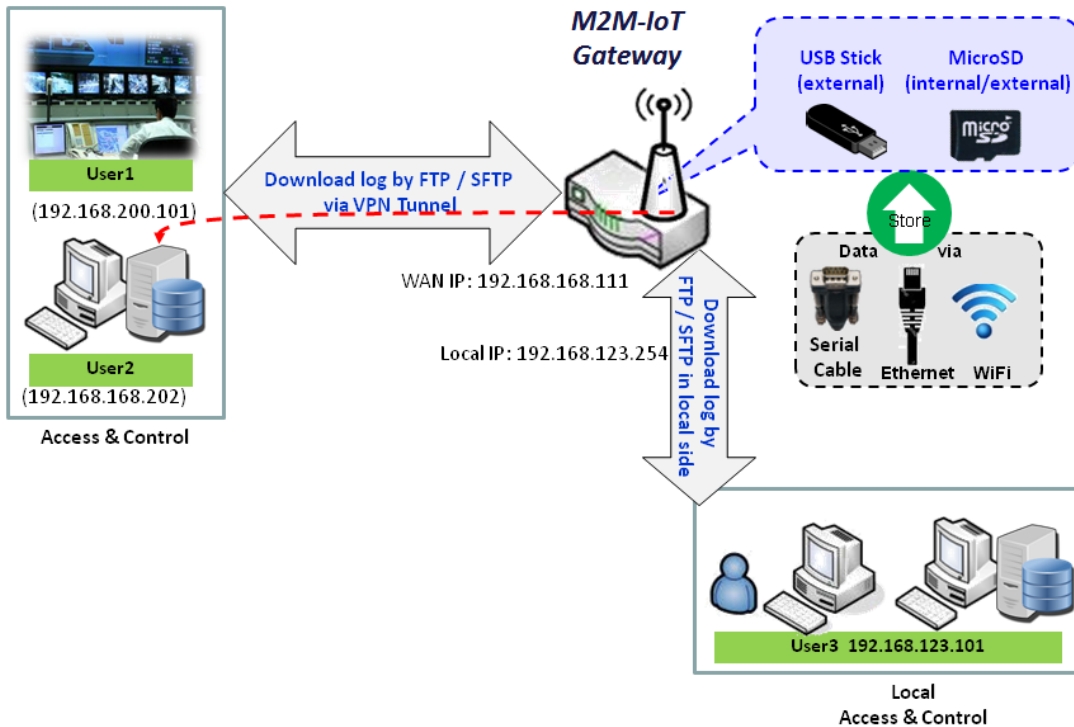

# 4G IIoT Gateway

## 6.3.1 Server Configuration

This section allows user to setup the embedded FTP and SFTP server for retrieving the interested fog files.

Go to **Administration > FTP > Server Configuration** tab.

### Enable FTP Server

FTP Server Configuration <span>Save</span>	
Item	Setting
▶ FTP	<input type="checkbox"/> Enable
▶ FTP Port	<input type="text" value="21"/>
▶ Timeout	<input type="text" value="300"/> second(s)(60-7200)
▶ Max. Connections per IP	<input type="text" value="2"/> ▼
▶ Max. FTP Clients	<input type="text" value="5"/> ▼
▶ PASV Mode	<input type="checkbox"/> Enable
▶ Port Range of PASV Mode	<input type="text" value="50000"/> ~ <input type="text" value="50031"/>
▶ Auto Report External IP in PASV Mode	<input type="checkbox"/> Enable
▶ ASCII Transfer Mode	<input type="checkbox"/> Enable
▶ FTPS(FTP over SSL/TLS)	<input type="checkbox"/> Enable

Configuration		
Item	Value setting	Description
<b>FTP</b>	The box is unchecked by default.	Check <b>Enable</b> box to activate the embedded FTP Server function. With the FTP Server enabled, you can retrieve or delete the stored log files via FTP connection. Note: The embedded FTP Server is only for log downloading, so no any write permission is implemented for user file upload to the storage.
<b>FTP Port</b>	Port <b>21</b> is set by default	Specify a port number for FTP connection. The gateway will listen for incoming FTP connections on the specified port. <b>Value Range:</b> 1 ~ 65535.
<b>Timeout</b>	<b>300</b> seconds is set by default.	Specify the maximum timeout interval for the FTP connection. Supported range is 60 to 7200 seconds.
<b>Max. Connections per IP</b>	<b>2</b> Clients are set by default.	Specify the maximum number of clients from the same IP address for the FTP connection. Up to 5 clients from the same IP address is supported.
<b>Max. FTP Clients</b>	<b>5</b> Clients are set by default.	Specify the maximum number of clients for the FTP connection. Up to 32 clients is supported.

# 4G IIoT Gateway

<b>PASV Mode</b>	Optional setting	Check the <b>Enable</b> box to activate the support of PASV mode for a FTP connection from FTP clients.
<b>Port Range of PASV Mode</b>	Port <b>50000 ~ 50031</b> is set by default.	Specify the port range to allocate for PASV style data connection. <b>Value Range:</b> 1024 ~ 65535.
<b>Auto Report External IP in PASV Mode</b>	Optional setting	Check the <b>Enable</b> box to activate the support of overriding the IP address advertising in response to the PASV command.
<b>ASCII Transfer Mode</b>	Optional setting	Check the <b>Enable</b> box to activate the support of ASCII mode data transfers. Binary mode is supported by default.
<b>FTPS (FTP over SSL/TLS)</b>	Optional setting	Check the <b>Enable</b> box to activate the support of secure connections via SSL/TLS.

## Enable SFTP Server

☐ SFTP Server Configuration
Save

Item	Setting
▶ SFTP	<input type="checkbox"/> Enable via <input type="checkbox"/> LAN via <input type="checkbox"/> WAN
▶ SFTP Port	<input style="width: 80px;" type="text" value="22"/>

Configuration		
Item	Value setting	Description
<b>SFTP</b>	The box is unchecked by default.	Check <b>Enable</b> box to activate the embedded SFTP Server function. Furthermore, you can check the granted interface(s) for the SFTP connection, via <b>LAN</b> , <b>WAN</b> , or both. With the SFTP Server enabled, you can retrieve or delete the stored log files via secure SFTP connection.
<b>SFTP Port</b>	Default 22	Specify a port number for SFTP connection. The gateway will listen for incoming SFTP connections on the specified port. <b>Value Range:</b> 1 ~ 65535.

# 4G IIoT Gateway

## 6.3.2 User Account

This section allows user to setup user accounts for logging to the embedded FTP and SFTP server to retrieve the interested fog files.

Go to **Administration > FTP > User Account** tab.

### Create/Edit FTP User Accounts

User Account List <input type="button" value="Add"/> <input type="button" value="Delete"/>						
ID	User Name	Password	Directory	Permission	Enable	Actions

When **Add** button is applied, **User Account Configuration** screen will appear.

User Account Configuration <input type="button" value="Save"/>	
Item	Setting
▶ User Name	<input type="text"/>
▶ Password	<input type="text"/>
▶ Directory	<input type="button" value="Browse"/>
▶ Permission	<input type="text" value="Read/Write"/>
▶ Enable	<input checked="" type="checkbox"/>

Configuration		
Item	Value setting	Description
<b>User Name</b>	String : non-blank string	Enter the user account for login to the FTP server. <b>Value Range: 1 ~ 15 characters.</b>
<b>Password</b>	String : no blank	Enter the user password for login to the FTP server.
<b>Directory</b>	N/A	Select a root directory after user login.
<b>Permission</b>	<b>Read/Write</b> is selected by default.	Select the Read/write permission. Note: The embedded FTP Server is only for log downloading, so no any write permission is implemented for user file upload to the storage, even <b>Read/Write</b> option is selected.
<b>Enable</b>	The box is checked by default.	Check the box to activate the FTP user account.

# 4G IIoT Gateway

## 6.4 Diagnostic

This gateway supports simple network diagnosis tools for the administrator to troubleshoot and find the root cause of the abnormal behavior or traffics passing through the gateway. There can be a Packet Analyzer to help record the packets for a designated interface or specific source/destination host, and another Ping and Tracert tools for testing the network connectivity issues.

### 6.4.1 Diagnostic Tools

The Diagnostic Tools provide some frequently used network connectivity diagnostic tools (approaches) for the network administrator to check the device connectivity.

Go to **Administration > Diagnostic > Diagnostic Tools** tab.

Diagnostic Tools	
Item	Setting
▶ Ping Test	Host IP: <input type="text"/> Outer Interface: <input type="text" value="Auto"/> LAN Source: <input type="text" value="Default"/> <input type="button" value="Ping"/>
▶ Tracert Test	Host IP: <input type="text"/> Interface: <input type="text" value="Auto"/> <input type="text" value="UDP"/> <input type="button" value="Tracert"/>
▶ Wake on LAN	<input type="text"/> <input type="button" value="Wake up"/>

Diagnostic Tools		
Item	Value setting	Description
<b>Ping Test</b>	Optional Setting	This allows you to specify an IP / FQDN, the Outer interface (auto, WAN, LAN, or VLAN), and LAN source (default, LAN, or VLAN) as well, so system will try to ping the specified device to test whether it is alive after clicking on the <b>Ping</b> button. A test result window will appear beneath it.
<b>Tracert Test</b>	Optional setting	Trace route (tracert) command is a network diagnostic tool for displaying the route (path) and measuring transit delays of packets across an IP network. Trace route proceeds until all (three) sent packets are lost for more than twice, then the connection is lost and the route cannot be evaluated. First, you need to specify an IP / FQDN, the test interface (LAN, WAN, or Auto) and the protocol (UDP or ICMP), and by default, it is <b>UDP</b> . Then, system will try to trace the specified host to test whether it is alive after clicking on <b>Tracert</b> button. A test result window will appear beneath it.
<b>Wake on LAN</b>	Optional setting	Wake on LAN (WOL) is an Ethernet networking standard that allows a computer to be turned on or awakened by a network message. You can specify the MAC address of the computer, in your LAN network, to be remotely turned on by clicking on the <b>Wake up</b> command button.
<b>Save</b>	N/A	Click the <b>Save</b> button to save the configuration.

# 4G IIoT Gateway

## 6.4.2 Packet Analyzer

The Packet Analyzer can capture packets depend on user settings. User can specify interfaces to capture packets and filter by setting rule. Ensure the log storage is available (either embedded SD-Card or external USB Storage), otherwise **Packet Analyzer** cannot be enabled.

Go to **Administration > Diagnostic > Packet Analyzer** tab.

Configuration	
Item	Setting
▶ Packet Analyzer	<input type="checkbox"/> Enable
▶ File Name	<input type="text"/>
▶ Split Files	<input type="checkbox"/> Enable File Size : <input type="text" value="200"/> <input type="text" value="KB"/> ▾
▶ Packet Interfaces	<input type="checkbox"/> WAN-1 <input type="checkbox"/> WAN-2 <input type="checkbox"/> ASY-1 <input type="text" value="Binary Mode"/> ▾ 2.4G : <input type="checkbox"/> VAP-1 <input type="checkbox"/> VAP-2 <input type="checkbox"/> VAP-3 <input type="checkbox"/> VAP-4 <input type="checkbox"/> VAP-5 <input type="checkbox"/> VAP-6 <input type="checkbox"/> VAP-7 <input type="checkbox"/> VAP-8

Configuration		
Item	Value setting	Description
<b>Packet Analyzer</b>	The box is unchecked by default.	Check <b>Enable</b> box to activate the Packet Analyzer function. If you cannot enable the checkbox, please check if the storage is available or not. Plug in the USB storage and then enable the Package Analyzer function.
<b>File Name</b>	1. An optional setting 2. Blank is set by default, and the default file name is <b>&lt;Interface&gt;_&lt;Date&gt;_&lt;index&gt;</b> .	Enter the file name to save the captured packets in log storage. If <b>Split Files</b> option is also enabled, the file name will be appended with an index code " <b>_&lt;index&gt;</b> ". The extension file name is <b>.pcap</b> .
<b>Split Files</b>	1. An optional setting 2. The default value of <b>File Size</b> is 200 KB.	Check <b>enable</b> box to split file whenever log file reaching the specified limit. If the <b>Split Files</b> option is enabled, you can further specify the <b>File Size</b> and <b>Unit</b> for the split files. <b>Value Range: 10 ~ 99999.</b> NOTE: <b>File Size</b> cannot be less than 10 KB
<b>Packet Interfaces</b>	An optional setting	Define the interface(s) that <b>Packet Analyzer</b> should work on. At least, one interface is required, but multiple selections are also accepted. The supported interfaces can be: <ul style="list-style-type: none"> <li>● <b>WAN:</b> When the WAN is enabled at <b>Physical Interface</b>, it can be selected here.</li> <li>● <b>ASY:</b> This means the serial communication interface. It is used to capture packets appearing in the <b>Field Communication</b>. Therefore, it can only be selected when specific field communication protocol, like Modbus, is enabled.</li> </ul>

# 4G IIoT Gateway

		Select <b>Binary mode</b> or <b>String mode</b> for the serial interface.
		<ul style="list-style-type: none"> <li>● <b>VAP</b>: This means the virtual AP. When WiFi and VAP are enabled, it can be selected here.</li> </ul>
<b>Save</b>	N/A	Click the <b>Save</b> button to save the configuration.
<b>Undo</b>	N/A	Click the <b>Undo</b> button to restore what you just configured back to the previous setting.

Once you enabled the Packet Analyzer function on specific Interface(s), you can further specify some filter rules to capture the packets which matched the rules.

Capture Filters	
Item	Setting
▶ Filter	<input type="checkbox"/> Enable
▶ Source MACs	<input type="text"/>
▶ Source IPs	<input type="text"/>
▶ Source Ports	<input type="text"/>
▶ Destination MACs	<input type="text"/>
▶ Destination IPs	<input type="text"/>
▶ Destination Ports	<input type="text"/>

Capture Filters		
Item	Value setting	Description
<b>Filter</b>	Optional setting	Check <b>Enable</b> box to activate the Capture Filter function.
<b>Source MACs</b>	Optional setting	Define the filter rule with <b>Source MACs</b> , which means the source MAC address of packets. Packets which match the rule will be captured. Up to 10 MACs are supported, but they must be separated with “;”, e.g. AA:BB:CC:DD:EE:FF; 11:22:33:44:55:66 The packets will be captured when match any one MAC in the rule.

## 4G IIoT Gateway

<b>Source IPs</b>	Optional setting	Define the filter rule with <b>Source IPs</b> , which means the source IP address of packets. Packets which match the rule will be captured. Up to 10 IPs are supported, but they must be separated with “;”, e.g. 192.168.1.1; 192.168.1.2 The packets will be captured when match any one IP in the rule.
<b>Source Ports</b>	Optional setting	Define the filter rule with <b>Source Ports</b> , which means the source port of packets. The packets will be captured when match any port in the rule. Up to 10 ports are supported, but they must be separated with “;”, e.g. 80; 53 <b>Value Range:</b> 1 ~ 65535.
<b>Destination MACs</b>	Optional setting	Define the filter rule with <b>Destination MACs</b> , which means the destination MAC address of packets. Packets which match the rule will be captured. Up to 10 MACs are supported, but they must be separated with “;”, e.g. AA:BB:CC:DD:EE:FF; 11:22:33:44:55:66 The packets will be captured when match any one MAC in the rule.
<b>Destination IPs</b>	Optional setting	Define the filter rule with <b>Destination IPs</b> , which means the destination IP address of packets. Packets which match the rule will be captured. Up to 10 IPs are supported, but they must be separated with “;”, e.g. 192.168.1.1; 192.168.1.2 The packets will be captured when match any one IP in the rule.
<b>Destination Ports</b>	Optional setting	Define the filter rule with <b>Destination Ports</b> , which means the destination port of packets. The packets will be captured when match any port in the rule. Up to 10 ports are supported, but they must be separated with “;”, e.g. 80; 53 <b>Value Range:</b> 1 ~ 65535.

## Chapter 7 Service

### 7.1 Cellular Toolkit

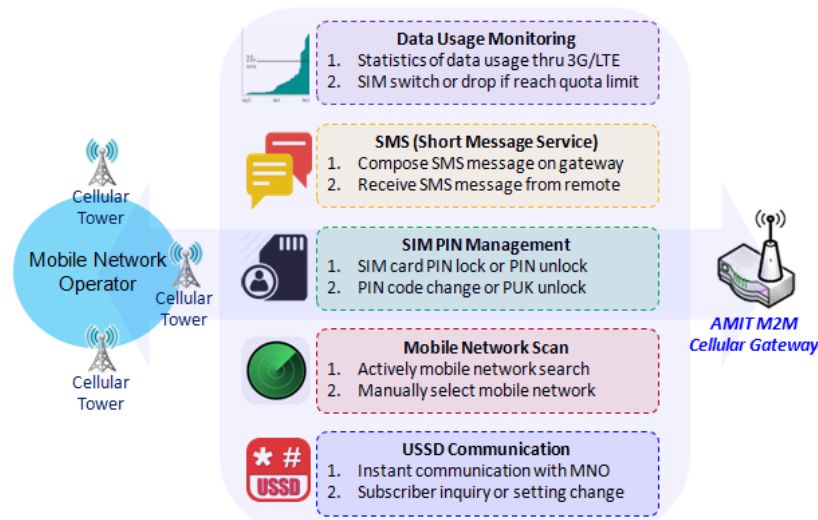

Besides cellular data connection, you may also like to monitor data usage of cellular WAN, sending text message through SMS, changing PIN code of SIM card, communicating with carrier/ISP by USSD command, or doing a cellular network scan for diagnostic purpose.

In Cellular Toolkit section, it includes several useful features that are related to cellular configuration or application. You can configure settings of Data Usage, SMS, SIM PIN, USSD, and Network Scan here. Please note at least a valid SIM card is required to be

inserted to device before you continue settings in this section.

The screenshot shows the Cellular Toolkit interface. The left sidebar contains menu items: Status, Basic Network, Object Definition, Field Communication, Security, Administration, Service, Cellular Toolkit (selected), and Event Handling. The main content area is titled 'Data Usage' and shows a '3G/4G Data Usage Profile List' table with columns: ID, SIM info, Carrier Name, Cycle Period, Start Date, Data Limitation, Connection Restrict, Enable, and Action. The table is currently empty.

# 4G IIoT Gateway

## 7.1.1 Data Usage

Most of data plan for cellular connection is with a limited amount of data usage. If data usage has been over limited quota, either you will get much lower data throughput that may affect your daily operation, or you will get a 'bill shock' in the next month because carrier/ISP charges a lot for the over-quota data usage.

With help from Data Usage feature, device will monitor cellular data usage continuously and take actions. If data usage reaches limited quota, device can be set to drop the cellular data connection right away. Otherwise, if secondary SIM card is inserted, device will switch to secondary SIM and establish another cellular data connection with secondary SIM automatically.

If Data Usage feature is enabled, all history of cellular data usage can be viewed at **Status > Statistics & Reports > Cellular Usage** tab.

3G/4G Data Usage Profile List <input type="button" value="Add"/> <input type="button" value="Delete"/>								
ID	SIM info	Carrier Name	Cycle Period	Start Date	Data Limitation	Connection Restrict	Enable	Action
1	3G/4G SIM A	ISP A	1 Monthly	Mon Feb 20 2017 00:00:00 GMT+0800	1GB	<input checked="" type="checkbox"/>	<input checked="" type="checkbox"/>	<input type="button" value="Edit"/> <input type="checkbox"/> Select

### 3G/4G Data Usage

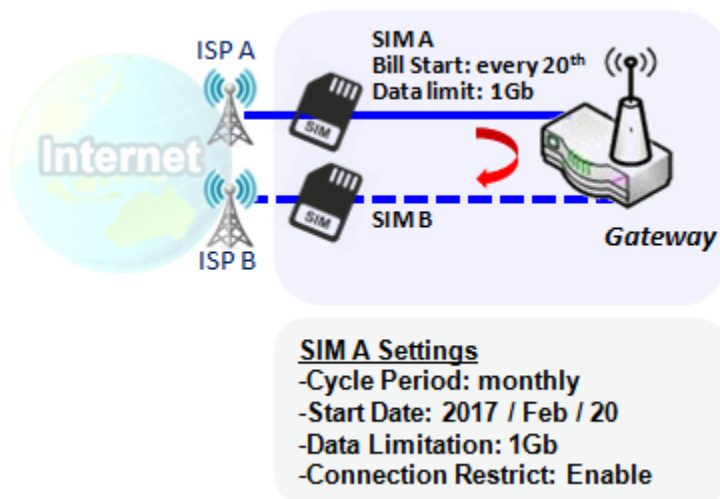

Data Usage feature enabling gateway device to continuously monitor cellular data usage and take actions. In the diagram, quota limit of SIM A is **1Gb** per month and bill start date is **20<sup>th</sup>** of every month. The device is smart to start a new calculation of data usage on every 20<sup>th</sup> of month. Enable Connection Restrict will force gateway device to drop cellular connection of SIM A when data usage reaches quota limit (1Gb in this case). If SIM failover feature is configured in **Internet Setup**, then gateway will switch to SIM B and establish a new cellular data connection automatically.

# 4G IIoT Gateway

## Data Usage Setting

Go to **Service > Cellular Toolkit > Data Usage** tab.

Before finished settings for Data Usage, you need to know bill start date, bill period, and quota limit of data usage according to your data plan. You can ask this information from your carrier or ISP.

### Create / Edit 3G/4G Data Usage Profile

3G/4G Data Usage Profile List <input type="button" value="Add"/> <input type="button" value="Delete"/>								
ID	SIM info	Carrier Name	Cycle Period	Start Date	Data Limitation	Connection Restrict	Enable	Action

When **Add** button is applied, 3G/4G Data Usage Profile Configuration screen will appear. You can create up to four data usage profiles, one profile for each SIM card used in the Gateway.

3G/4G Data Usage Profile Configuration	
Item	Setting
▶ SIM Select	3G/4G ▼ SIM A ▼
▶ Carrier Name	<input type="text"/>
▶ Cycle Period	Days ▼ 90 <input type="text"/>
▶ Start Date	2016 ▼ / October ▼ / 11 ▼
▶ Data Limitation	<input type="text"/> KB ▼
▶ Connection Restrict	<input type="checkbox"/> Enable
▶ Enable	<input checked="" type="checkbox"/> Enable

3G/4G Data Usage Profile Configuration		
Item Setting	Value setting	Description
<b>SIM Select</b>	<b>3G/4G-1</b> and <b>SIM A</b> by default.	Choose a cellular interface ( <b>3G/4G-1</b> or <b>3G/4G-2</b> ), and a SIM card bound to the selected cellular interface to configure its data usage profile. <b>Note:</b> <b>3G/4G-2</b> is only available for for the product with dual cellular module.
<b>Carrier Name</b>	It is an optional item.	Fill in the Carrier Name for the selected SIM card for identification.
<b>Cycle Period</b>	<b>Days</b> by default	The first box has three types for cycle period. They are <b>Days</b> , <b>Weekly</b> and <b>Monthly</b> . <b>Days:</b> For per Days cycle periods, you have to further specify the number of days in the second box. <b>Value Range:</b> 1 ~ 90 days. <b>Weekly, Monthly:</b> The cycle period is one week or one month.
<b>Start Date</b>	N/A	Specify the date to start measure network traffic. Please don't select the day before now, otherwise, the traffic statistics will be

## 4G IIoT Gateway

---

		incorrect.
<b>Data Limitation</b>	N/A	Specify the allowable data limitation for the defined cycle period.
<b>Connection Restrict</b>	Un-Checked by default.	Check the <b>Enable</b> box to activate the connection restriction function. During the specified cycle period, if the actual data usage exceeds the allowable data limitation, the cellular connection will be forced to disconnect.
<b>Enable</b>	Un-Checked by default.	Check the <b>Enable</b> box to activate the data usage profile.

# 4G IIoT Gateway

## 7.1.2 SMS

Short Message Service (SMS) is a text messaging service, which is used to be widely-used on mobile phones. It uses standardized communications protocols to allow mobile phones or cellular devices to exchange short text messages in an instant and convenient way.

### SMS Setting

Go to **Service > Cellular Toolkit > SMS** tab

With this gateway device, you can send SMS text messages or browse received SMS messages as you usually do on a cellular phone.

### Setup SMS Configuration

Configuration	
Item	Setting
▶ Physical Interface	3G/4G-1 ▼
▶ SMS	<input checked="" type="checkbox"/> Enable SIM Status: SIM_A
▶ SMS Storage	SIM Card Only ▼
▶ SMS Space	<input type="checkbox"/> Enable & Keep Available Space <input type="text" value=""/> (1-10)

Configuration Item	Value setting	Description
<b>Physical Interface</b>	The box is <b>3G/4G-1</b> by default	Choose a cellular interface ( <b>3G/4G-1</b> or <b>3G/4G-2</b> ) for the following SMS function configuration. <b>Note: 3G/4G-2</b> is only available for for the product with dual cellular module.
<b>SMS</b>	The box is checked by default	This is the SMS switch. If the box checked that the SMS function enable, if the box unchecked that the SMS function disable.
<b>SIM Status</b>	N/A	Depend on currently SIM status. The possible value will be <b>SIM_A</b> or <b>SIM_B</b> .
<b>SMS Storage</b>	The box is <b>SIM Card Only</b> by default	This is the SMS storage location. Currently the option only <b>SIM Card Only</b> .
<b>SMS Space</b>	The box is unchecked by default	Check the Enable box and specify a number (1-10) for message count to reserve some available storage space and prevent it from run out of storage. The oldest message(s) will be deleted when the SMS storage is going to full.
<b>Save</b>	N/A	Click the <b>Save</b> button to save the settings

# 4G IIoT Gateway

## SMS Summary

Show **Unread SMS**, **Received SMS**, **Sent SMS**, **Remaining SMS**, and edit SMS context to send, read SMS from SIM card.

SMS Summary		New SMS	SMS Inbox	SMS Sent Folder
Item	Setting			
▶ Unread SMS	0			
▶ Received SMS	0			
▶ Sent SMS	0			
▶ Remaining SMS	0			

SMS Summary		
Item	Value setting	Description
<b>Unread SMS</b>	N/A	If SIM card insert to router first time, unread SMS value is zero. When received the new SMS but didn't read, this value plus one.
<b>Received SMS</b>	N/A	This value record the existing SMS numbers from SIM card, When received the new SMS, this value plus one.
<b>Sent SMS</b>	N/A	This value record the number of out going SMS, When sent one SMS, this value plus one.
<b>Remaining SMS</b>	N/A	This value is SMS capacity minus received SMS, When received the new SMS, this value minus one.
<b>New SMS</b>	N/A	Click <b>New SMS</b> button, a <b>New SMS</b> screen appears. User can set the SMS setting from this screen. Refer to New SMS in the next page.
<b>SMS Inbox</b>	N/A	Click <b>SMS Inbox</b> button, a <b>SMS Inbox List</b> screen appears. User can read or delete SMS, reply SMS or forward SMS from this screen. Refer to SMS Inbox List in the next page.
<b>Refresh</b>	N/A	Click the <b>Refresh</b> button to update the SMS summary immediately.

# 4G IIoT Gateway

## New SMS

You can set the SMS setting from this screen.

Item	Setting
▶ Receivers	<input type="text"/> (Use '+' for International Format and ';' to Compose Multiple Receivers)
▶ Text Message	<div style="border: 1px solid #ccc; height: 100px;"></div> Length of Current Input : 0
▶ Result	

New SMS		
Item	Value setting	Description
Receivers	N/A	Write the receivers to send SMS. User need to add the semicolon and compose multiple receivers that can group send SMS.
Text Message	N/A	Write the SMS context to send SMS. The router supports up to a maximum of 1023 character for SMS context length.
Send	N/A	Click the <b>Send</b> button, above text message will be sent as a SMS.
Result	N/A	If SMS has been sent successfully, it will show <b>Send OK</b> , otherwise <b>Send Failed</b> will be displayed.

## SMS Inbox List

You can read or delete SMS, reply SMS or forward SMS from this screen.

ID	From Phone Number	Timestamp	SMS Text Preview	Actions
----	-------------------	-----------	------------------	---------

SMS Inbox List		
Item	Value setting	Description
ID	N/A	The number of SMS.
From Phone Number	N/A	Sender List (Phone Number) for the received SMS
Timestamp	N/A	What time the SMS is received
SMS Text Preview	N/A	Preview the SMS text. Click the <b>Detail</b> button to read a certain message.

# 4G IIoT Gateway

<b>Action</b>	The box is unchecked by default	Click the <b>Detail</b> button to read the SMS detail; Click the <b>Reply / Forward</b> button to reply/forward SMS. Besides, you can check the box(es), and then click the <b>Delete</b> button to delete the checked SMS(s).
<b>Refresh</b>	N/A	Refresh the SMS Inbox List.
<b>Delete</b>	N/A	Delete the SMS for all checked box from Action.
<b>Close</b>	N/A	Close the Detail SMS Message screen.

## SMS Sent Folder

You can read or delete SMS from this screen.

SMS Sent Folder <span>Delete</span> <span>Close</span>				
ID	Receivers	Timestamp	SMS Text Preview	Actions

SMS Sent Folder		
Item	Value setting	Description
<b>ID</b>	N/A	The number of SMS.
<b>Receivers</b>	N/A	Receiver list for the sent SMS.
<b>Timestamp</b>	N/A	What time the SMS is sent
<b>SMS Text Preview</b>	N/A	Preview the SMS text. Click the <b>Detail</b> button to read a certain message.
<b>Action</b>	The box is unchecked by default	Click the <b>Detail</b> button to read the SMS detail Besides, you can check the box(es), and then click the <b>Delete</b> button to delete the checked record(s).
<b>Refresh</b>	N/A	Refresh the SMS Sent Folder.
<b>Delete</b>	N/A	Delete the SMS for all checked box from Action.
<b>Close</b>	N/A	Close the Detail SMS Message screen.

# 4G IIoT Gateway

## 7.1.3 SIM PIN

With most cases in the world, users need to insert a SIM card (a.k.a. UICC) into end devices to get on cellular network for voice service or data surfing. The SIM card is usually released by mobile operators or service providers. Each SIM card has a unique number (so-called ICCID) for network owners or service providers to identify each subscriber. As SIM card plays an important role between service providers and subscribers, some security mechanisms are required on SIM card to prevent any unauthorized access.

Enabling a PIN code in SIM card is an easy and effective way of protecting cellular devices from unauthorized access. This gateway device allows you to activate and manage PIN code on a SIM card through its web GUI.

### Activate PIN code on SIM Card

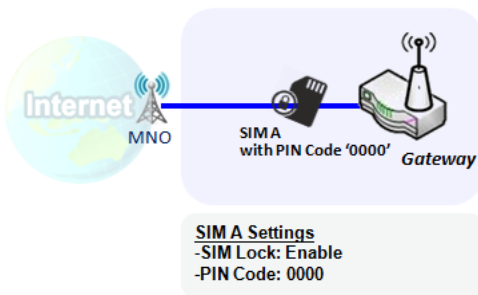

This gateway device allows you to activate PIN code on SIM card. This example shows how to activate PIN code on SIM-A for 3G/4G-1 with default PIN code “0000”.

### Change PIN code on SIM Card

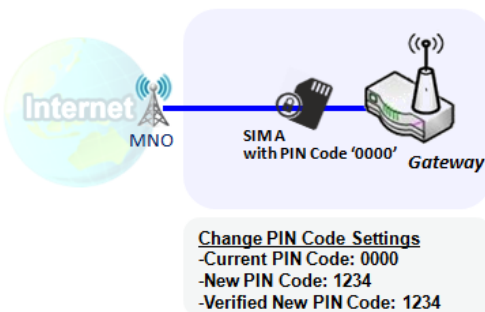

This gateway device allows you to change PIN code on SIM card. Following the example above, you need to type original PIN code “0000”, and then type new PIN code with ‘1234’ if you like to set new PIN code as ‘1234’. To confirm the new PIN code you type is what you want, you need to type new PIN code ‘1234’ in Verified New PIN Code again.

### Unlock SIM card by PUK Code

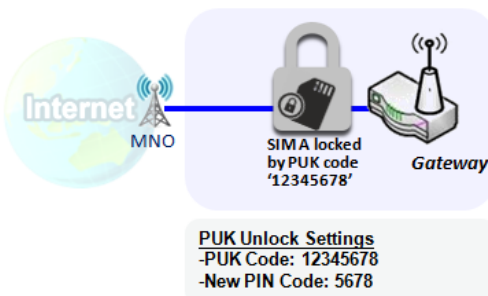

If you entered incorrect PIN code at configuration page for 3G/4G-1 WAN over three times, and then it will cause SIM card to be locked by PUK code. Then you have to call service number to get a PUK code to unlock SIM card. In the diagram, the PUK code is “12345678” and new PIN code is “5678”.

# 4G IIoT Gateway

## SIM PIN Setting

Go to **Service** > **Cellular Toolkit** > **SIM PIN** Tab

With the SIM PIN Function window, it allows you to enable or disable SIM lock (which means protected by PIN code), or change PIN code. You can also see the information of remaining times of failure trials as we mentioned earlier. If you run out of these failure trials, you need to get a PUK code to unlock SIM card.

### Select a SIM Card

Configuration	
Item	Setting
▶ Physical Interface	3G/4G-1 ▼
▶ SIM Status	SIM-A Ready
▶ SIM Selection	SIM-A ▼ <input type="button" value="Switch"/>

Configuration Window		
Item	Value setting	Description
<b>Physical Interface</b>	The box is <b>3G/4G-1</b> by default	Choose a cellular interface ( <b>3G/4G-1</b> or <b>3G/4G-2</b> ) to change the SIM PIN setting for the selected SIM Card. <b>Note: 3G/4G-2</b> is only available for for the product with dual cellular module.
<b>SIM Status</b>	N/A	Indication for the selected SIM card and the SIM card status. The status could be <b>Ready</b> , <b>Not Insert</b> , or <b>SIM PIN</b> . <b>Ready</b> -- SIM card is inserted and ready to use. It can be a SIM card without PIN protection or that SIM card is already unlocked by correct PIN code. <b>Not Insert</b> -- No SIM card is inserted in that SIM slot. <b>SIM PIN</b> -- SIM card is protected by PIN code, and it's not unlocked by a correct PIN code yet. That SIM card is still at locked status.
<b>SIM Selection</b>	N/A	Select the SIM card for further SIM PIN configuration. Press the <b>Switch</b> button, then the Gateway will switch SIM card to another one. After that, you can configure the SIM card.

# 4G IIoT Gateway

## Enable / Change PIN Code

Enable or Disable PIN code (password) function, and even change PIN code function.

SIM function <input type="button" value="Save"/> <input type="button" value="Change PIN Code"/>	
Item	Setting
▶ SIM lock	<input type="checkbox"/> Enable PIN Code: <input type="text"/> (4~8 digits)
▶ Remaining times	3

SIM function Window		
Item Setting	Value setting	Description
<b>SIM lock</b>	Depend on SIM card	Click the <b>Enable</b> button to activate the SIM lock function. For the first time you want to enable the SIM lock function, you have to fill in the PIN code as well, and then click <b>Save</b> button to apply the setting.
<b>Remaining times</b>	Depend on SIM card	Represent the remaining trial times for the SIM PIN unlocking.
<b>Save</b>	N/A	Click the <b>Save</b> button to apply the setting.
<b>Change PIN Code</b>	N/A	Click the <b>Change PIN code</b> button to change the PIN code (password). If the <b>SIM Lock</b> function is not enabled, the <b>Change PIN code</b> button is disabled. In the case, if you still want to change the PIN code, you have to enable the SIM Lock function first, fill in the PIN code, and then click the <b>Save</b> button to enable. After that, You can click the <b>Change PIN code</b> button to change the PIN code.

When **Change PIN Code** button is clicked, the following screen will appear.

Item	Setting
▶ Current PIN Code	<input type="text"/> (4~8 digits)
▶ New PIN Code	<input type="text"/> (4~8 digits)
▶ Verified New PIN Code	<input type="text"/> (4~8 digits)

Item	Value Setting	Description
<b>Current PIN Code</b>	A Must filled setting	Fill in the current (old) PIN code of the SIM card.
<b>New PIN Code</b>	A Must filled setting	Fill in the new PIN Code you want to change.
<b>Verified New PIN Code</b>	A Must filled setting	Confirm the new PIN Code again.
<b>Apply</b>	N/A	Click the <b>Apply</b> button to change the PIN code with specified new PIN code.
<b>Cancel</b>	N/A	Click the <b>Cancel</b> button to cancel the changes and keep current PIN code.

# 4G IIoT Gateway

**Note:** If you changed the PIN code for a certain SIM card, you must also change the corresponding PIN code specified in the **Basic Network > WAN & Uplink > Internet Setup > Connection with SIM Card** page. Otherwise, it may result in wrong SIM PIN trials with invalid (old) PIN code.

## Unlock with a PUK Code

The PUK Function window is only available for configuration if that SIM card is locked by PUK code. It means that SIM card is locked and needs additional PUK code to unlock. Usually it happens after too many trials of incorrect PIN code, and the remaining times in SIM Function table turns to 0. In this situation, you need to contact your service provider and request a PUK code for your SIM card, and try to unlock the locked SIM card with the provided PUK code. After unlocking a SIM card by PUK code successfully, the SIM lock function will be activated automatically.

PUK function <span>Save</span>	
Item	Setting
▶ PUK status	PUK unlock.
▶ Remaining times	N/A
▶ PUK Code	<input type="text"/> (8 digits)
▶ New PIN Code	<input type="text"/> (4~8 digits)

PUK Function Window		
Item	Value setting	Description
<b>PUK status</b>	<b>PUK Unlock / PUK Lock</b>	Indication for the PUK status. The status could be <b>PUK Lock</b> or <b>PUK Unlock</b> . As mentioned earlier, the SIM card will be locked by PUK code after too many trials of failure PIN code. In this case, the PUK Status will turns to <b>PUK Lock</b> . In a normal situation, it will display <b>PUK Unlock</b> .
<b>Remaining times</b>	Depend on SIM card	Represent the remaining trial times for the PUK unlocking. Note : <b>DO NOT make the remaining times down to zero, it will damage the SIM card FOREVER !</b> Call for your ISP's help to get a correct PUK and unlock the SIM if you don't have the PUK code.
<b>PUK Code</b>	A Must filled setting	Fill in the PUK code (8 digits) that can unlock the SIM card in PUK unlock status.
<b>New PIN Code</b>	A Must filled setting	Fill in the New PIN Code (4~8 digits) for the SIM card. You have to determine your new PIN code to replace the old, forgotten one. Keep the PIN code (password) in mind with care.
<b>Save</b>	N/A	Click the <b>Save</b> button to apply the setting.

**Note:** If you changed the PUK code and PIN code for a certain SIM card, you must also change the corresponding PIN code specified in the **Basic Network > WAN & Uplink > Internet Setup > Connection with SIM Card** page. Otherwise, it may result in wrong SIM PIN trials with invalid (old) PIN code.

# 4G IIoT Gateway

## 7.1.4 USSD

Unstructured Supplementary Service Data (USSD) is a protocol used by GSM cellular telephones to communicate with the service provider's computers. USSD can be used for WAP browsing, prepaid callback service, mobile-money services, location-based content services, menu-based information services, and as part of configuring the phone on the network.

An USSD message is up to 182 alphanumeric characters in length. Unlike Short Message Service (SMS) messages, USSD messages create a real-time connection during an USSD session. The connection remains open, allowing a two-way exchange of a sequence of data. This makes USSD more responsive than services that use SMS.

Configuration				
Item	Setting			
Physical Interface	3G/4G-1	SIM Status: SIM_A		
USSD Profile List				
Add Delete				
ID	Profile Name	USSD Command	Comments	Actions
1	roaming setting	*135#	Roaming function	Edit <input type="checkbox"/> Select
USSD Profile Configuration				
Save				
Item	Setting			
Profile Name	roaming setting			
USSD Command	*135#			
Comments	Roaming function			
USSD Request				
Send Clear				
Item	Setting			
USSD Profile	roaming setting			
USSD Command	*135#			
USSD Response	< ChungHwa Data Roaming Services> 1 Order 2 Query 3 Setting 4 使用中文			

### USSD Scenario

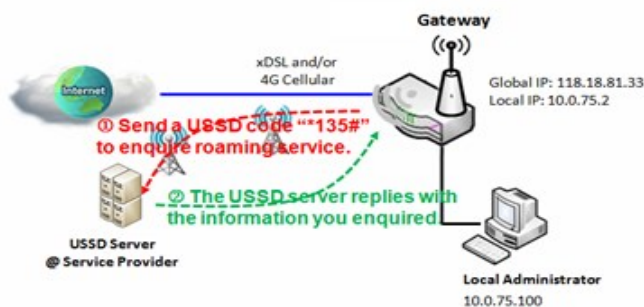

USSD allows you to have an instant bi-directional communication with carrier/ISP. In the diagram, the USSD command '\*135#' is referred to data roaming services. After sending that USSD command to carrier, you can get a response at window USSD Response. Please note the USSD command varies for different carriers/ISP.

# 4G IIoT Gateway

## USSD Setting

Go to **Service > Cellular Toolkit > USSD** tab.

In "USSD" page, there are four windows for the USSD function. The "Configuration" window can let you specify which 3G/4G module (physical interface) is used for the USSD function, and system will show which SIM card in the module is the current used one. The second window is the "USSD Profile List" and it shows all your defined USSD profiles that store pre-commands for activating an USSD session. An "Add" button in the window can let you add one new USSD profile and define the command for the profile in the third window, the "USSD Profile Configuration". When you want to start the activation of an USSD connection session to the USSD server, select the USSD profile or type in the correct pre-command, and then click on the "Send" button for the session. The responses from the USSD server will be displayed beneath the "USSD Command" line. When commands typed in the "USSD Command" field are sent, received responses will be displayed in the "USSD Response" blank space. User can communicate with the USSD server by sending USSD commands and getting USSD responses via the gateway.

## USSD Configuration

Configuration	
Item	Setting
Physical Interface	3G/4G-1 SIM Status: SIM_A

Configuration Item	Value setting	Description
Physical Interface	The box is <b>3G/4G-1</b> by default.	Choose a cellular interface ( <b>3G/4G-1</b> or <b>3G/4G-2</b> ) to configure the USSD setting for the connected cellular service (identified with <b>SIM_A</b> or <b>SIM_B</b> ). <b>Note:</b> <b>3G/4G-2</b> is only available for for the product with dual cellular module.
SIM Status	N/A	Show the connected cellular service (identified with <b>SIM_A</b> or <b>SIM_B</b> ).

## Create / Edit USSD Profile

The cellular gateway allows you to custom your USSD profile. It supports up to a maximum of 35 USSD profiles.

USSD Profile List <input type="button" value="Add"/> <input type="button" value="Delete"/>				
ID	Profile Name	USSD Command	Comments	Actions

# 4G IIoT Gateway

When **Add** button is applied, **USSD Profile Configuration** screen will appear.

USSD Profile Configuration <span>Save</span>	
Item	Setting
▶ Profile Name	<input type="text"/>
▶ USSD Command	<input type="text"/>
▶ Comments	<input type="text"/>

USSD Profile Configuration		
Item	Value setting	Description
<b>Profile Name</b>	N/A	Enter a name for the USSD profile.
<b>USSD Command</b>	N/A	Enter the USSD command defined for the profile. Normally, it is a command string composed with numeric keypad "0~9", "*", and "#". The USSD commands are highly related to the cellular service, please check with your service provider for the details.
<b>Comments</b>	N/A	Enter a brief comment for the profile.

## Send USSD Request

When **send** the USSD command, the USSD Response screen will appear.

When click the **Clear** button, the USSD Response will disappear.

USSD Request <span>Send</span> <span>Clear</span>	
Item	Setting
▶ USSD Profile	<input type="text" value="--- Option ---"/>
▶ USSD Command	<input type="text"/>

USSD Request		
Item	Value setting	Description
<b>USSD Profile</b>	N/A	Select a USSD profile name from the dropdown list.
<b>USSD Command</b>	N/A	The USSD Command string of the selected profile will be shown here.
<b>USSD Response</b>	N/A	Click the <b>Send</b> button to send the USSD command, and the <b>USSD Response</b> screen will appear. You will see the response message of the corresponding service, receive the service SMS.

# 4G IIoT Gateway

## 7.1.5 Network Scan

"Network Scan" function can let administrator specify the device how to connect to the mobile system for data communication in each 3G/4G interface. For example, administrator can specify which generation of mobile system is used for connection, 2G, 3G or LTE. Moreover, he can define their connection sequence for the gateway device to connect to the mobile system automatically. Administrator also can scan the mobile systems in the air manually, select the target operator system and apply it. The manual scanning approach is used for problem diagnosis.

### Network Scan Setting

Go to **Service > Cellular Toolkit > Network Scan** tab.

In "Network Scan" page, there are two windows for the Network Scan function. The "Configuration" window can let you select which 3G/4G module (physical interface) is used to perform Network Scan, and system will show the current used SIM card in the module. You can configure each 3G/4G WAN interface by executing the network scanning one after another. You can also specify the connection sequence of the targeted generation of mobile system, 2G/3G/LTE.

### Network Scan Configuration

Configuration	
Item	Setting
▶ Physical Interface	3G/4G-1 ▼ SIM Status: SIM_A
▶ Network Type	Auto ▼
▶ Scan Approach	Auto ▼

Configuration		
Item	Value setting	Description
<b>Physical Interface</b>	The box is <b>3G/4G-1</b> by default	Choose a cellular interface ( <b>3G/4G-1</b> or <b>3G/4G-2</b> ) for the network scan function. <b>Note: 3G/4G-2</b> is only available for for the product with dual cellular module.
<b>SIM Status</b>	N/A	Show the connected cellular service (identified with <b>SIM_A</b> or <b>SIM_B</b> ).
<b>Network Type</b>	<b>Auto</b> is selected by default.	Specify the network type for the network scan function. It can be Auto, or LTE Only. When <b>Auto</b> is selected, the network will be register automatically; If the <b>prefer</b> option is selected, network will be register for your option first; If the <b>only</b> option is selected, network will be register for your option only.
<b>Scan Approach</b>	<b>Auto</b> is selected by default.	When <b>Auto</b> selected, cellular module register automatically. If the <b>Manually</b> option is selected, a <b>Network Provider List</b> screen appears. Press <b>Scan</b> button to scan for the nearest base stations. Select (check the box) the preferred base stations then click <b>Apply</b> button to apply settings.

# 4G IIoT Gateway

**Save** N/A Click **Save** to save the settings

The second window is the "Network Provider List" window and it appears when the **Manually** Scan Approach is selected in the Configuration window. By clicking on the "Scan" button and wait for 1 to 3 minutes, the found mobile operator system will be displayed for you to choose. Click again on the "Apply" button to drive system to connect to that mobile operator system for the dedicated 3G/4G interface.

Network Provider List <input type="button" value="Scan"/> <input type="button" value="Apply"/>			
Provider Name	Mobile System	Network Status	Action
Chunghwa Telecom	4G	Current	<input type="checkbox"/> Select
Far EasTone	3G	Forbidden	<input type="checkbox"/> Select

# 4G IIoT Gateway

## 7.2 SMS & Event

SMS & Event handling is the application that allows administrator to setup the pre-defined events, handlers, or response behavior with individual profiles. With properly configuring the event handling function, administrator can easily and remotely obtain the status and information via the purchased gateway. Moreover, he can also handle and manage some important system related functions, even the field bus devices and D/O devices which are already well connected to.

The supported events are categorized into two groups: the **managing events** and **notifying events**.

The **managing events** are the events that are used to manage the gateway or change the setting / status of the specific functionality of the gateway. On receiving the managing event, the gateway will take action to change the functionality, collect the required status for administration, and also change the status of a certain connected field bus device simultaneously.

The **notifying events** are the events that some related objects have been triggered and take corresponding actions on the occurrence of the events. It could be an event generated from the connected sensor, or a certain connected field bus device for alerting the administrator something happened with SMS message, Email, and SNMP Trap, etc...

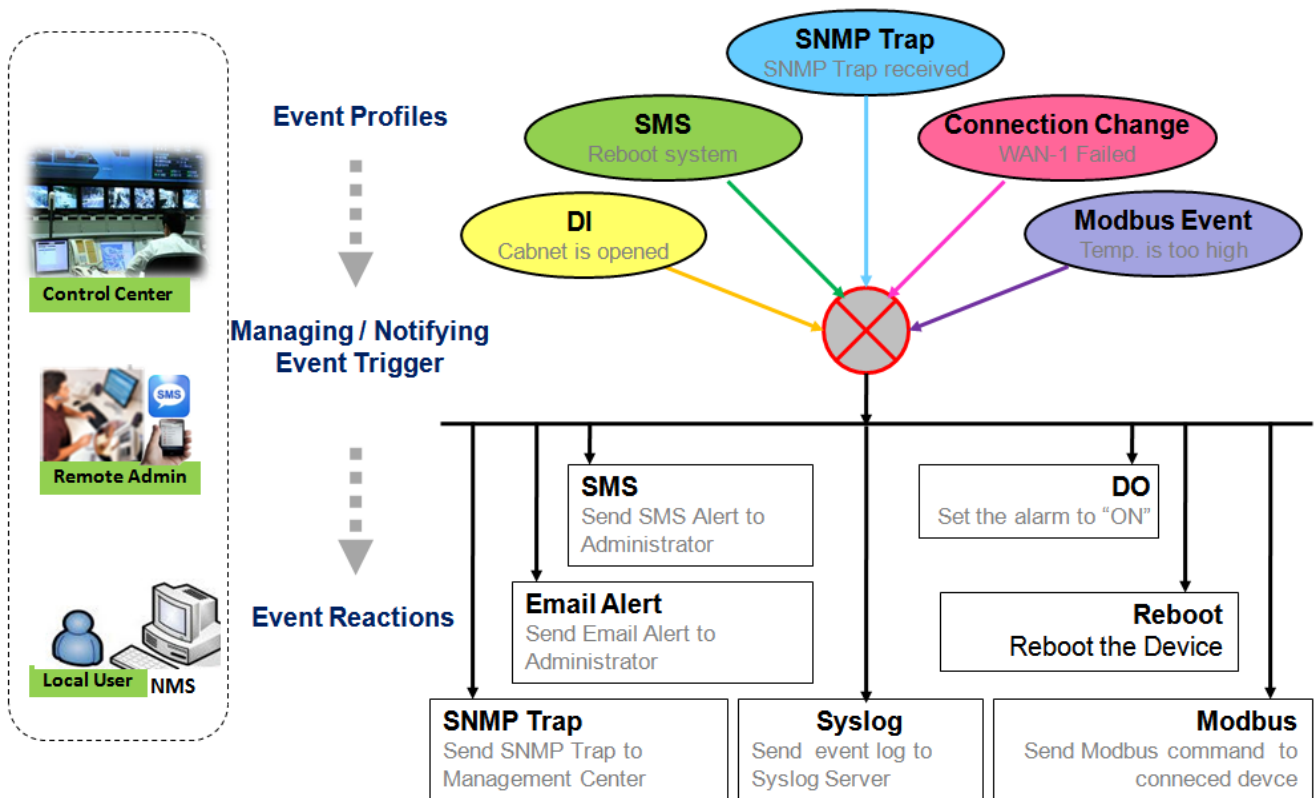

For ease of configuration, administrator can create and edit the common pre-defined managing / notifying event profiles for taking instant reaction on a certain event or managing the devices for some advanced useful purposes. For example, sending/receiving remote managing SMS for the gateway's routine maintaining, the

# 4G IIoT Gateway

---

field bus device status monitoring, digital sensors detection controlling, and so on. All of such management and notification function can be realized effectively via the Event Handling feature.

The following is the summary lists for the provided profiles, and events:

(**Note:** The available profiles and events could be different for the purchased product.)

- Profiles (Rules):
  - SMS Configuration and Accounts
  - Email Accounts
  - Digital Input (DI) profiles
  - Digital Output (DO) profiles
  - Modbus Managing Event profiles
  - Modbus Notifying Event profiles
  - Remote Host profiles
  
- Managing Events:
  - Trigger Type: SMS, SNMP Trap, and Digital Input (DI).
  - Actions: Get the Network Status; or Configure the LAN/VLAN behavior, WIFI behavior, NAT behavior, Firewall behavior, VPN behavior, System Management, Administration, Digital Output behavior, connected Modbus devices, and Remote Host.
  
- Notifying Events:
  - Trigger Type: Digital Input, Power Change, Connection Change (WAN, LAN & VLAN, WiFi, DDNS), Administration, Modbus, and Data Usage.
  - Actions: Notify the administrator with SMS, Syslog, SNMP Trap or Email Alert; Change the status of connected Digital Output or Modbus devices; Sending collected information to Remote Host.

To use the event handling function, First of all, you have to enable the event management setting and configure the event details with the provided profile settings. You can create or edit pre-defined profiles for individual managing / notifying events. The profile settings are separated into several items; they are the SMS Account Definition, Email Service Definition, Digital Input (DI) Profile Configuration, Digital Output (DO) Profile Configuration, Modbus Definition, and Remote Host Configuration.

Then, you have to configure each managing / notifying event with identifying the event's trigger condition, and the corresponding actions (reaction for the event) for the event. For each event, more than one action can be activated simultaneously.

# 4G IIoT Gateway

## 7.2.1 Configuration

Go to **Service > SMS & Event > Configuration** Tab.

Event handling is the service that allows administrator to setup the pre-defined events, handlers, or response behavior with individual profiles.

### Enable Event Management

Configuration	
Item	Setting
▶ Event Management	<input type="checkbox"/> Enable

Configuration		
Item	Value setting	Description
<b>Event Management</b>	The box is unchecked by default	Check the <b>Enable</b> box to activate the Event Management function.

### Enable SMS Management

To use the SMS management function, you have to configure some important settings first.

SMS Configuration	
Item	Setting
▶ Message Prefix	<input type="checkbox"/> Enable & <input type="text"/>
▶ Physical Interface	<input type="text" value="3G/4G-1"/> SIM Status: SIM_A
▶ Delete Managed SMS after Processing	<input type="checkbox"/> Enable

SMS Configuration		
Item	Value setting	Description
<b>Message Prefix</b>	The box is unchecked by default	Click the <b>Enable</b> box to enable the SMS prefix for validating the received SMS. Once the function is enabled, you have to enter the prefix behind the checkbox. The received managing events SMS must have the designated prefix as an initial identifier, then corresponding handlers will become effective for further processing.

# 4G IIoT Gateway

<b>Physical Interface</b>	The box is 3G/4G-1 by default.	Choose a cellular interface ( <b>3G/4G-1</b> or <b>3G/4G-2</b> ) to configure the SMS management setting. <b>Note:</b> <b>3G/4G-2</b> is only available for for the product with dual cellular module.
<b>SIM Status</b>	N/A	Show the connected cellular service (identified with <b>SIM_A</b> or <b>SIM_B</b> ).
<b>Delete Managed SMS after Processing</b>	The box is unchecked by default	Check the <b>Enable</b> box to delete the received managing event SMS after it has been processed.

## Create / Edit SMS Account

Setup the SMS Account for managing the gateway through the SMS. It supports up to a maximum of 5 accounts.

SMS Account List <input type="button" value="Add"/> <input type="button" value="Delete"/>						
ID	Phone Number	Phone Description	Application	Send confirmed SMS	Enable	Actions

You can click the **Add / Edit** button to configure the SMS account.

SMS Account Configuration	
Item	Setting
▶ Phone Number	Specific Number ▼ <input type="text"/>
▶ Phone Description	<input type="text"/>
▶ Application	<input type="checkbox"/> Event Trigger <input type="checkbox"/> Notify Handle
▶ Send confirmed SMS	<input type="checkbox"/> Enable
▶ Enable	<input checked="" type="checkbox"/> Enable
<input type="button" value="Save"/>	

SMS Account Configuration		
Item	Value setting	Description
<b>Phone Number</b>	1. Mobile phone number format 2. A Must filled setting	Select the Phone number policy from the drop list, and specify a mobile phone number as the SMS account identifier if required. It can be <b>Specific Number</b> , or <b>Allow Any</b> . If <b>Specific Number</b> is selected, you have to specify the phone number as the SMS account identifier. <b>Value Range:</b> -1 ~ 32 digits.
<b>Phone Description</b>	1. Any text 2. An Optional setting	Specify a brief description for the SMS account.
<b>Application</b>	A Must filled setting	Specify the application type. It could be <b>Event Trigger</b> , <b>Notify Handle</b> , or <b>both</b> . If the Phone Number policy is <b>Allow Any</b> , the Noftify Handle will be unavailable.
<b>Send confirmed</b>	1. An Optional setting 2. The box is unchecked by	Click <b>Enable</b> box to active the SMS response function. The gateway will send a confirmed message back to the sender whenever it

# 4G IIoT Gateway

<b>SMS</b>	default.	received a SMS managing event. The confirmed message is similar to following format: "Device received a SMS with command xxxxx."
<b>Enable</b>	The box is unchecked by default.	Click <b>Enable</b> box to activate this account.
<b>Save</b>	NA	Click the <b>Save</b> button to save the configuration.

## Create / Edit Email Service Account

Setup the Email Service Account for event notification. It supports up to a maximum of 5 accounts.

Email Service List <input type="button" value="Add"/> <input type="button" value="Delete"/>				
ID	Email Server	Email Addresses	Enable	Actions

You can click the **Add / Edit** button to configure the Email account.

Email Service Configuration	
Item	Setting
▶ Email Server	<input type="text" value="--- Option --- ▼"/>
▶ Email Addresses	<input type="text"/>
▶ Enable	<input checked="" type="checkbox"/> Enable
<input type="button" value="Save"/>	

Email Service Configuration		
Item	Value setting	Description
<b>Email Server</b>	--- Option ---	Select an Email Server profile from <b>External Server</b> setting for the email account setting.
<b>Email Addresses</b>	1. Internet E-mail address format 2. A Must filled setting	Specify the Destination Email Addresses.
<b>Enable</b>	The box is unchecked by default.	Click <b>Enable</b> box to activate this account.
<b>Save</b>	NA	Click the <b>Save</b> button to save the configuration

# 4G IIoT Gateway

## Create / Edit Digital Input (DI) Profile Rule (DI/DO support required)

Setup the Digital Input (DI) Profile rules. It supports up to a maximum of 10 profiles.

Digital Input (DI) Profile List <span>Add</span> <span>Delete</span>								
ID	DI Profile Name	Description	DI Source	Continues Update Status	Normal Level	Signal Active Time (s)	Enable	Actions

When **Add** button is applied, the **Digital Input (DI) Profile Configuration** screen will appear.

Digital Input (DI) Profile Configuration	
Item	Setting
▶ DI Profile Name	<input type="text"/>
▶ Description	<input type="text"/>
▶ DI Source	ID1 ▼
▶ Continues Update Status	<input type="checkbox"/> Enable & Update Interval <input type="text" value="2"/> (2~86400 seconds)
▶ Normal Level	Low ▼
▶ Signal Active Time	<input type="text" value="1"/> (seconds)
▶ Profile	<input checked="" type="checkbox"/> Enable
<span>Save</span>	

Digital Input (DI) Profile Configuration		
Item	Value setting	Description
<b>DI Profile Name</b>	1. String format 2. A Must filled setting	Specify the DI Profile Name. <b>Value Range:</b> -1 ~ 32 characters.
<b>Description</b>	1. Any text 2. An Optional setting	Specify a brief description for the profile.
<b>DI Source</b>	ID1 by default	Specify the DI Source. It could be ID1 or ID2. The number of available DI source could be different for the purchased product.
<b>Contiune Update Status</b>	The box is unchecked by default.	Click <b>Enable</b> box to activate this function for the DI event with designated update interval setting. If the event condition keeps active for a long time interval, the gateway will send repeated notify events for each check interval.  <b>Value Range:</b> 2 ~ 86400 seconds.  <b>Note :</b> To prevent receiving too much notify event for the same situation, you can adjust the check interval to a proper one for your application.
<b>Normal Level</b>	Low by default	Specify the Normal Level. It could be <b>Low</b> or <b>High</b> .
<b>Signal Active Time</b>	1. Numeric String format 2. A Must filled setting	Specify the Signal Active Time. It could be from 1 to 10 seconds. The <b>Signal Active Time</b> setting will be ignored when 'Continue Update Status' function is enabled

# 4G IIoT Gateway

		<b>Value Range:</b> 1 ~ 10 seconds.
<b>Profile</b>	The box is unchecked by default.	Click <b>Enable</b> box to activate this profile setting.
<b>Save</b>	NA	Click the <b>Save</b> button to save the configuration.

## Create / Edit Digital Output (DO) Profile Rule (DI/DO support required)

Setup the Digital Output (DO) Profile rules. It supports up to a maximum of 10 profiles.

Digital Output (DO) Profile List <span>Add</span> <span>Delete</span>									
ID	DO Profile Name	Description	DO Source	Normal Level	Total Signal Period (ms)	Repeat & Counter	Duty Cycle(%)	Enable	Actions

When **Add** button is applied, the **Digital Output (DO) Profile Configuration** screen will appear.

Digital Output (DO) Profile Configuration	
Item	Setting
▶ DO Profile Name	<input type="text"/>
▶ Description	<input type="text"/>
▶ DO Source	ID1 ▼
▶ Normal Level	Low ▼
▶ Total Signal Period	10 <input type="text"/> (ms)
▶ Repeat & Counter	<input type="checkbox"/> Enable & Counter: <input type="text" value="0"/>
▶ Duty Cycle	<input type="text"/> (%)
▶ Profile	<input checked="" type="checkbox"/> Enable
<span>Save</span>	

Digital Output (DO) Profile Configuration		
Item	Value setting	Description
<b>DO Profile Name</b>	1. String format 2. A Must filled setting	Specify the DO Profile Name. <b>Value Range:</b> -1 ~ 32 characters.
<b>Description</b>	1. Any text 2. An Optional setting	Specify a brief description for the profile.
<b>DO Source</b>	ID1 by default	Specify the DO Source. It could be ID1.
<b>Normal Level</b>	Low by default	Specify the Normal Level. It could be <b>Low</b> or <b>High</b> .
<b>Total Signal Period</b>	1. Numeric String format 2. A Must filled setting	Specify the Total Signal Period. <b>Value Range:</b> 10 ~ 10000 ms.
<b>Repeat &amp; Counter</b>	The box is unchecked by default.	Check the Enable box to activate the repeated Digital Output, and specify the Repeat times. <b>Value Range:</b> 0 ~ 65535.

# 4G IIoT Gateway

<b>Duty Cycle</b>	1. Numeric String format 2. A Must filled setting	Specify the Duty Cycle for the Digital Output. <b>Value Range:</b> 1 ~100 %.
<b>Profile</b>	The box is unchecked by default.	Click <b>Enable</b> box to activate this profile setting.
<b>Save</b>	N/A	Click the <b>Save</b> button to save the configuration.

## Create / Edit Modbus Notifying Events Profile (Modbus support required)

Setup the Modbus Notifying Events Profile. It supports up to a maximum of 32 profiles.

Modbus Notifying Events Profile List <input type="button" value="Add"/> <input type="button" value="Delete"/>												
ID	Modbus Name	Description	Read Function	Modbus Mode	IP	Port	Device ID	Register	Logic Comparator	Value	Enable	Actions
1	co2_level	read co2 level to check if it bigger than 60	Read Holding Registers (0x03)	TCP	122.22.33.44	987	78	3	>	60	<input checked="" type="checkbox"/>	<input type="button" value="Edit"/> <input type="checkbox"/> Select

You can click the **Add / Edit** button to configure the profile.

Modbus Notifying Events Profile Configuration	
Item	Setting
▶ Modbus Name	<input type="text"/>
▶ Description	<input type="text"/>
▶ Read Function	Read Coils (0x01) ▼
▶ Modbus Mode	Serial ▼
▶ IP	<input type="text"/>
▶ Port	<input type="text"/>
▶ Device ID	<input type="text"/>
▶ Register	<input type="text"/>
▶ Logic Comparator	> ▼
▶ Value	0 <input type="text"/>
▶ Enable	<input checked="" type="checkbox"/> Enable
<input type="button" value="Save"/>	

# 4G IIoT Gateway

Modbus Notifying Events Profile		
Item	Value setting	Description
<b>Modbus Name</b>	1. String format 2. A Must filled setting	Specify the Modbus profile name. <b>Value Range:</b> -1 ~ 32 characters.
<b>Description</b>	1. Any text 2. An Optional setting	Specify a brief description for the profile.
<b>Read Function</b>	Read Holding Registers by default	Specify the Read Function for <b>Notifying Events</b> .
<b>Modbus Mode</b>	<b>Serial</b> by default	Specify the Modbus Mode. It could be <b>Serial</b> or <b>TCP</b> .
<b>IP</b>	1. NA for Serial on Modbus Mode. 2. A Must filled setting for TCP on Modbus Mode.	Specify the IP for TCP on Modbus Mode. IPv4 Format.
<b>Port</b>	1. NA for Serial on Modbus Mode. 2. A Must filled setting for TCP on Modbus Mode.	Specify the Port for TCP on Modbus Mode. <b>Value Range:</b> 1 ~ 65535.
<b>Device ID</b>	1. Numeric String format 2. A Must filled setting	Specify the Device ID of the modbus device. It could be from 1 to 247.
<b>Register</b>	1. Numeric String format 2. A Must filled setting	Specify the Register number of the modbus device. <b>Value Range:</b> 0 ~ 65535.
<b>Logic Comparator</b>	Logic Comparator '>' by default.	Specify the Logic Comparator for <b>Notifying Events</b> . It could be '>', '<', '=, '>=', or '<='.
<b>Value</b>	1. Numeric String format 2. A Must filled setting	Specify the Value. <b>Value Range:</b> 0 ~ 65535.
<b>Enable</b>	The box is unchecked by default.	Click <b>Enable</b> box to activate this profile setting.
<b>Save</b>	NA	Click the <b>Save</b> button to save the configuration
<b>Undo</b>	NA	Click the <b>Undo</b> button to restore what you just configured back to the previous setting.

## Create / Edit Modbus Managing Events Profile (Modbus support required)

Setup the Modbus Managing Events Profile. It supports up to a maximum of 32 profiles.

Modbus Managing Events Profile List <input type="button" value="Add"/> <input type="button" value="Delete"/>											
ID	Modbus Name	Description	Write Function	Modbus Mode	IP	Port	Device ID	Register	Value	Enable	Actions
1	water_pump	write water pump to control the motor speed high-low	Write Single Register (0x06)	TCP	233.44.55.66	876	247	44	5678	<input checked="" type="checkbox"/>	<input type="button" value="Edit"/> <input type="button" value="Select"/>

You can click the **Add / Edit** button to configure the profile.

# 4G IIoT Gateway

Modbus Managing Events Profile Configuration	
Item	Setting
▶ Modbus Name	<input type="text"/>
▶ Description	<input type="text"/>
▶ Write Function	Write Single Coil (0x05) ▼
▶ Modbus Mode	Serial ▼
▶ IP	<input type="text"/>
▶ Port	<input type="text"/>
▶ Device ID	<input type="text"/>
▶ Register	<input type="text"/>
▶ Value	0 <input type="text"/>
▶ Enable	<input checked="" type="checkbox"/> Enable
<input type="button" value="Save"/>	

Modbus Managing Events Profile		
Item	Value setting	Description
<b>Modbus Name</b>	1. String format 2. A Must filled setting	Specify the Modbus profile name. <b>Value Range:</b> -1 ~ 32 characters.
<b>Description</b>	1. Any text 2. An Optional setting	Specify a brief description for the profile.
<b>Write Function</b>	Write Single Registers by default	Specify the Write Function for <b>Managing Events</b> .
<b>Modbus Mode</b>	<b>Serial</b> by default	Specify the Modbus Mode. It could be <b>Serial</b> or <b>TCP</b> .
<b>IP</b>	1. NA for Serial on Modbus Mode. 2. A Must filled setting for TCP on Modbus Mode.	Specify the IP for TCP on Modbus Mode. IPv4 Format.
<b>Port</b>	1. NA for Serial on Modbus Mode. 2. A Must filled setting for TCP on Modbus Mode.	Specify the Port for TCP on Modbus Mode. <b>Value Range:</b> 1 ~ 65535.
<b>Device ID</b>	1. Numeric String format 2. A Must filled setting	Specify the Device ID of the modbus device. <b>Value Range:</b> 1 ~ 247.
<b>Register</b>	1. Numeric String format 2. A Must filled setting	Specify the Register number of the modbus device. <b>Value Range:</b> 0 ~ 65535.
<b>Value</b>	1. Numeric String format 2. A Must filled setting	Specify the Value. <b>Value Range:</b> 0 ~ 65535.
<b>Enable</b>	The box is unchecked by default.	Click <b>Enable</b> box to activate this profile setting.
<b>Save</b>	NA	Click the <b>Save</b> button to save the configuration
<b>Undo</b>	NA	Click the <b>Undo</b> button to restore what you just configured back to the previous setting.

# 4G IIoT Gateway

## Create / Edit Remote Host Profile

Setup the Remote Host Profile. It supports up to a maximum of 10 profiles.

Remote Host List <input type="button" value="Add"/> <input type="button" value="Delete"/>								
ID	Host Name	Host IP	Protocol Type	Port Number	Prefix Message	Suffix Message	Enable	Actions

You can click the **Add / Edit** button to configure the profile.

Remote Host Configuration	
Item	Setting
▶ Host Name	<input type="text"/>
▶ Host IP	<input type="text"/>
▶ Protocol Type	TCP ▼
▶ Port Number	<input type="text"/>
▶ Prefix Message	<input type="text"/>
▶ Suffix Message	<input type="text"/>
▶ Enable	<input type="checkbox"/>
<input type="button" value="Save"/>	

Remote Host Configuration		
Item	Value setting	Description
<b>Host Name</b>	1. String format 2. A Must filled setting	Specify the Remote Host profile name. <b>Value Range:</b> -1 ~ 64 characters.
<b>Host IP</b>	1. A Must filled setting 2. IP Address format.	Specify the IP address for the Remote Host. IPv4 Format.
<b>Protocol Type</b>	1. A Must filled setting 2. <b>TCP</b> is selected by default	Specify the protocol to access the Remote Host. It could be <b>TCP</b> or <b>UDP</b> .
<b>Port Number</b>	1. A Must filled setting	Specify the Port number for accessing the Remote Host. <b>Value Range:</b> 1 ~ 65535.
<b>Prefix Message</b>	1. String format 2. An Optional filled setting	Specify the Prefix Message string as pre-defined identification for accessing the remote host, if required. <b>Value Range:</b> -1 ~ 64 characters.
<b>Suffix Message</b>	1. String format 2. An Optional filled setting	Specify the Suffix Message string as pre-defined identification for accessing the remote host, if required. <b>Value Range:</b> -1 ~ 64 characters.
<b>Enable</b>	The box is unchecked by	Click <b>Enable</b> box to activate this profile setting.

# 4G IloT Gateway

---

	default.	
<b>Save</b>	NA	Click the <b>Save</b> button to save the configuration
<b>Undo</b>	NA	Click the <b>Undo</b> button to restore what you just configured back to the previous setting.

# 4G IIoT Gateway

## 7.2.2 Managing Events

Managing Events allow administrator to define the relationship (rule) among event trigger, handlers and response.

Go to **Service > SMS & Event > Managing Events** Tab.

### Enable Managing Events

Configuration	
Item	Setting
▶ Managing Events	<input type="checkbox"/> Enable

Configuration		
Item	Value setting	Description
<b>Managing Events</b>	The box is unchecked by default	Check the <b>Enable</b> box to activate the Managing Events function.

### Create / Edit Managing Event Rules

Setup the Managing Event rules. It supports up to a maximum of 128 rules.

Managing Event List						Add	Delete
ID	Event	Trigger Type	Description	Enable	Actions		

When **Add** or **Edit** button is applied, the **Managing Event Configuration** screen will appear.

# 4G IIoT Gateway

Managing Event Configuration	
Item	Setting
▶ Event	None ▼ None ▼ None ▼
▶ Trigger Type	Period ▼
▶ Interval	0 (0~86400 seconds)
▶ Description	
▶ Action	<input type="checkbox"/> Network Status <input type="checkbox"/> LAN&VLAN <input type="checkbox"/> WiFi <input type="checkbox"/> NAT <input type="checkbox"/> Firewall <input type="checkbox"/> VPN <input type="checkbox"/> System Manage <input type="checkbox"/> Administration <input type="checkbox"/> Digital Output <input type="checkbox"/> Modbus <input type="checkbox"/> Remote Host
▶ Managing Event	<input checked="" type="checkbox"/> Enable
<input type="button" value="Save"/>	

Managing Event Configuration		
Item	Value setting	Description
<b>Event</b>	<b>None</b> by default	Specify the Event type ( <b>SMS</b> , <b>SNMP Trap</b> , or <b>Digital Input</b> ) and an event identifier / profile. Up to 3 event conditions can be specified for defining an event, and the event will be triggered when all the conditions hold simultaneously (AND relation).  The supported Event types could be: <b>SMS</b> : Select <b>SMS</b> and fill the message in the textbox to as the trigger condition for the event; <b>SNMP</b> : Select <b>SNMP Trap</b> and fill the message in the textbox to specify SNMP Trap Event; <b>Digital Input</b> : Select <b>Digital Input</b> and a DI profile you defined to specify a certain Digital Input Event;  <i>Note: The available Event Type could be different for the purchased product.</i>
<b>Trigger Type</b>	<b>Period</b> is selected by default	Specify the type of event trigger, either <b>Period</b> or <b>Once</b> . <b>Period</b> : Select <b>Period</b> and specify a time interval, the event will be repeatedly triggered on every time interval when the specified event condition holds. <b>Once</b> : Select <b>Once</b> and the event will be just triggered just one time when the specified event condition holds.
<b>Interval</b>	<b>0</b> is set by default	Specify the repeatedly event trigger time interval.  <b>Value Range</b> : 0 ~86400 seconds.

# 4G IIoT Gateway

<b>Description</b>	String format : any text.	Enter a brief description for the Managing Event.
<b>Action</b>	All box is unchecked by default.	<p>Specify <b>Network Status</b>, or at least one rest action to take when the expected event is triggered.</p> <p><b>Network Status:</b> Select <b>Network Status</b> Checkbox to get the network status as the action for the event;</p> <p><b>LAN&amp;VLAN:</b> Select <b>LAN&amp;VLAN</b> Checkbox and the interested sub-items (Port link On/Off), the gateway will change the settings as the action for the event;</p> <p><b>WiFi:</b> Select <b>WiFi</b> Checkbox and the interested sub-items (WiFi radio On/Off), the gateway will change the settings as the action for the event;</p> <p><b>NAT:</b> Select <b>NAT</b> Checkbox and the interested sub-items (Virtual Server Rule On/Off, DMZ On/Off), the gateway will change the settings as the action for the event;</p> <p><b>Firewall:</b> Select <b>Firewall</b> Checkbox and the interested sub-items (Remote Administrator Host ID On/Off), the gateway will change the settings as the action for the event;</p> <p><b>VPN:</b> Select <b>VPN</b> Checkbox and the interested sub-items (IPSec Tunnel ON/Off, PPTP Client On/Off, L2TP Client On/Off, OpenVPN Client On/Off), the gateway will change the settings as the action for the event;</p> <p><b>GRE:</b> Select <b>GRE</b> Checkbox and the interested sub-items (GRE Tunnel On/Off), the gateway will change the settings as the action for the event;</p> <p><b>System Manage:</b> Select <b>System Manage</b> Checkbox and the interested sub-items (WAN SSH Service On/Off, the gateway will change the settings as the action for the event;</p> <p><b>Administration:</b> Select <b>Administration</b> Checkbox and the interested sub-items (Backup Config, Restore Config, Reboot, Save Current Setting as Default), the gateway will change the settings as the action for the event;</p> <p><b>Digital Output:</b> Select <b>Digital Output</b> checkbox and a DO profile you defined as the action for the event;</p> <p><b>Modbus:</b> Select <b>Modbus</b> checkbox and a Modbus Managing Event profile you defined as the action for the event;</p> <p><b>Remote Host:</b> Select <b>Remote Host</b> checkbox and a Remote Host profile you defined as the action for the event;</p> <p><i>Note: The available Event Type could be different for the purchased product.</i></p>
<b>Managing Event</b>	The box is unchecked by default.	Click <b>Enable</b> box to activate this Managing Event setting.
<b>Save</b>	NA	Click the <b>Save</b> button to save the configuration
<b>Undo</b>	NA	Click the <b>Undo</b> button to restore what you just configured back to the previous setting.

# 4G IIoT Gateway

## 7.2.3 Notifying Events

Go to **Service > SMS & Event > Notifying Events** Tab.

Notifying Events Setting allows administrator to define the relationship (rule) between event trigger and handlers.

### Enable Notifying Events

Configuration	
Item	Setting
▶ Notifying Events	<input checked="" type="checkbox"/> Enable

Configuration		
Item	Value setting	Description
<b>Notifying Events</b>	The box is unchecked by default	Check the <b>Enable</b> box to activate the Notifying Events function.

### Create / Edit Notifying Event Rules

Setup your Notifying Event rules. It supports up to a maximum of 128 rules.

Notifying Event List							
ID	Event	Trigger Type	Description	Action	Time Schedule	Enable	Actions

When **Add** or **Edit** button is applied, the **Notifying Event Configuration** screen will appear.

# 4G IIoT Gateway

Notifying Event Configuration	
Item	Setting
▶ Event	None ▼ None ▼ None ▼
▶ Trigger Type	Period ▼
▶ Interval	0 (0~86400 seconds)
▶ Description	
▶ Action	<input type="checkbox"/> Digital Output <input type="checkbox"/> SMS <input type="checkbox"/> Syslog <input type="checkbox"/> SNMP Trap <input type="checkbox"/> Email Alert <input type="checkbox"/> Modbus <input type="checkbox"/> Remote Host
▶ Time Schedule	(0) Always ▼
▶ Notifying Events	<input checked="" type="checkbox"/> Enable
<input type="button" value="Save"/>	

## Notifying Event Configuration

Item	Value setting	Description
<b>Event</b>	<b>None</b> by default	<p>Specify the Event type and corresponding event configuration. Up to 3 event conditions can be specified for defining an event, and the event will be triggered when all the conditions hold simultaneously (AND relation).</p> <p>The supported Event Type could be:</p> <p><b>Digital Input:</b> Select <b>Digital Input</b> and a DI profile you defined to specify a certain Digital Input Event;</p> <p><b>Power Change:</b> Select <b>Power Change</b> and a trigger condition to specify the event on a certain power source.</p> <p><b>WAN:</b> Select <b>WAN</b> and a trigger condition to specify a certain WAN Event;</p> <p><b>LAN&amp;VLAN:</b> Select <b>LAN&amp;VLAN</b> and a trigger condition to specify a certain LAN&amp;VLAN Event;</p> <p><b>WiFi:</b> Select <b>WiFi</b> and a trigger condition to specify a certain WiFi Event;</p> <p><b>DDNS:</b> Select <b>DDNS</b> and a trigger condition to specify a certain DDNS Event;</p> <p><b>Administration:</b> Select <b>Administration</b> and a trigger condition to specify a certain Administration Event;</p> <p><b>Modbus:</b> Select <b>Modbus</b> and a Modbus Notifying Event profile you defined to specify a certain Modbus Event;</p> <p><b>Data Usage:</b> Select <b>Data Usage</b>, the SIM Card (Cellular Service) and a trigger condition to specify a certain Data Usage Event;</p> <p><i>Note: The available Event Type could be different for the purchased product.</i></p>
<b>Description</b>	String format : any text.	Enter a brief description for the Notifying Event.
<b>Action</b>	All box is unchecked by	Specify at least one action to take when the expected event is triggered.

# 4G IIoT Gateway

	default.	<p><b>Digital Output:</b> Select <b>Digital Output</b> checkbox and a DO profile you defined as the action for the event;</p> <p><b>SMS:</b> Select <b>SMS</b>, and the gateway will send out a SMS to all the defined SMS accounts as the action for the event;</p> <p><b>Syslog:</b> Select <b>Syslog</b> and select/unselect the Enable Checkbox to as the action for the event;</p> <p><b>SNMP Trap:</b> Select <b>SNMP Trap</b>, and the gateway will send out SNMP Trap to the defined SNMP Event Receivers as the action for the event;</p> <p><b>Email Alert:</b> Select <b>Email Alert</b>, and the gateway will send out an Email to the defined Email accounts as the action for the event;</p> <p><b>Modbus:</b> Select <b>Modbus</b> and a Modbus Notifying Event profile you defined as the action for the event;</p> <p><b>Remote Host:</b> Select <b>Remote Host</b> checkbox and a Remote Host profile you defined as the action for the event;</p> <p><i>Note: The available Event Type could be different for the purchased product.</i></p>
<b>Time Schedule</b>	<b>(0) Always</b> is selected by default	Select a time scheduling rule for the Notifying Event.
<b>Notifying Events</b>	The box is unchecked by default.	Click <b>Enable</b> box to activate this Notifying Event setting.
<b>Save</b>	NA	Click the <b>Save</b> button to save the configuration
<b>Undo</b>	NA	Click the <b>Undo</b> button to restore what you just configured back to the previous setting.

# 4G IIoT Gateway

## 7.3 Location Tracking

Location tracking applications are usually referred to applications that take benefits from Global Navigation Satellite System (GNSS). GNSS is the infrastructure that allows devices to determine its position, velocity, and time by processing satellites signals from outer space. GNSS includes varieties of satellite systems and Satellite-Based Augmentation Systems (SBAS). SBAS is usually used for improving positioning accuracy. The tables below show 4 major GNSS system in the world, and SBAS system in different areas.

### Major GNSS System in the world

GNSS System	Owner
GPS	USA
GLONASS	Russia
Galileo	European Union
BeiDou (COMPASS)	China

### Satellite-Based Augmentation System (SBAS)

SBAS	Area Coverage
EGNOS	Europe
WAAS	North America
GAGAN	India
MSAS	Japan

Position applications are widely-used by varieties of industrial applications, including Location-Based Services (LBS), Automatic Vehicle Location (AVL), Fleet Management, or assets tracking. However, in most case, GNSS is a one-way communication. That means GNSS-compatible device can only locate its location by receiving GNSS signal, but it can't forward its location data to any other identity through GNSS system. According to this limitation by GNSS system, devices usually need to equip other technology to transmit their location data to back-end server for track or further analysis. Furthermore, as the position applications are more applied on moving objects, a kind of wireless technology would be more suitable to be adopted to transmit location data. Nowadays, thanks to popularity and wide coverage of cellular technology (GSM, 3G, 4G/LTE), transmitting location data to remote center in real time is no longer a hurdle. In addition, the data format of location data is NMEA 0183 compatible, so the back-end server will be easy to interpret the collected location data.

Hereunder are the main features of GNSS function in cellular gateway, if optional GNSS function is supported.

# 4G IIoT Gateway



- Retrieve GNSS data from satellites and send to remote operation center periodically or save in local storage.
- Global positioning with multiple GNSS systems, including GPS, and optional for GLONASS, Galileo, or BeiDou.
- Mandatory for varieties of LBS (Location-Based Service) applications, such as advertisement, emergent call.
- Easy integration with AVL (Automatic Vehicle Location) applications, for managing fleet of service vehicles.
- Other value-added applications, such as asset tracking, electronic toll collection, intelligent transport system.

## 7.3.1 GNSS

With GNSS configuration page, you can configure those functions that are mentioned above. Please note the available GNSS features on different models may be different. Please check product datasheet for details.

The configuration steps include following items.

- Activate GNSS feature in gateway and finish settings of cellular WAN.
- Support NMEA 0183 (compatible to 3.0) protocol, and allow customized prefix and suffix.
- Configurable GPS data logging on local microSD card storage for route record tracking.
- Indicate remote host, time interval, TCP/UDP, and type of GPS data that would be sent.

### ● GPS Message Type

This item shows all supported types of NMEA 0183 data format. NMEA 0183 data format was defined and maintained by National Marine Electronics Association (NMEA). Select one or more types that you want to use for transmitting GPS data. In most case, this configuration depends on which data format that your central server can recognize. Only select the type you need, otherwise it will consume unnecessary network bandwidth. The table below shows more information for different types of NMEA 0183 message.

Type	Description	Example
GGA	Fix Information	\$GPGGA,123519,4807.038,N,01131.000,E,1,08,0.9,545.4,M,46.9,M,,*47
GLL	Lat/Lon Data	\$GPGLL,4916.45,N,12311.12,W,225444,A,*1D

# 4G IIoT Gateway

GSA	Overall Satellite Data	\$GPGSA,A,3,04,05,,09,12,,,24,,,,,2.5,1.3,2.1*39
GSV	Detailed Satellite Data	\$GPGSV,2,1,08,01,40,083,46,02,17,308,41,12,07,344,39,14,22,228,45*75
RMC	Recommended Minimum Data	\$GPRMC,123519,A,4807.038,N,01131.000,E,022.4,084.4,230394,003.1,W*6A
VTG	Vector Track and Speed Over the Ground	\$GPVTG,054.7,T,034.4,M,005.5,N,010.2,K*48

Please note this option is hardware dependent. The available options of GPS message type show on this page is according to product specification. You may not see all options if your product doesn't support all of them.

## ● SBAS

SBAS is Satellite-Based Augmentation Systems that is used to improve accuracy of location data. There are several SBAS systems for different areas in the world.

SBAS	Area Coverage
EGNOS	Europe
WAAS	North America
GAGAN	India
MSAS	Japan

Please note this option is hardware dependent. You may not see this option if your product doesn't support it.

## ● Assisted GPS

Assisted GPS (as known as A-GPS) is used for speeding up location fix, especially when satellite signal is weak. If activating this option, gateway will download almanac data from A-GPS server through IP network instead of from satellite. You can also choose different valid period of almanac data. The shorter almanac data will get higher accuracy. However, the almanac data with shorter valid period needs to be updated more frequently. It will consume more network bandwidth. Please note this option is hardware dependent. You may not see this option if your product doesn't support it.

## ● Data to Storage

Besides transmitting location data to remote server, you can also store location data into internal storage (e.g. microSD card) or external storage (e.g. USB drive) if any. Regarding to data format, either can be NMEA 0183 raw data format or save it as GPX file format. The location data will be saved to a new file if the original file size is bigger than the pre-defined file size. The "Download log file" button allows you to browse all saved log files and download to your personal devices.

# 4G IIoT Gateway

## ➤ Scenario of location tracking for fleet management

A fleet owner would like to see the locations of his trucks in real time. He also likes to know where his trucks have been passed through with time information. In his operation office, there is a server (IP: 100.100.100.1) which can interpret NMEA RMC data format and shows truck's location and track on map. This server is listening on TCP port 888 to receive NMEA RMC packet from trucks. IMEI number will be added before NMEA RMC data for identification of each truck. Hereunder is the configuration on each truck.

### Basic Settings:

Configuration Path	[GNSS]-[Configuration]
GNSS	<i>Enable</i>
GNSS Type	<i>GPS</i>
GPS Message Types	<i>RMC</i>
SBAS	<i>Enable</i>
Assisted GPS	<i>Enable, 1</i>
Data to Storage	<i>Disable</i>

### Settings for Remote Host:

Configuration Path	[GNSS]-[Remote Host Configuration]
Host Name	<i>Truck-1</i>
Host IP	<i>100.100.100.1</i>
Protocol Type	<i>TCP</i>
Port Number	<i>888</i>
Interval(s)	<i>15</i>
Prefix Message	<i>123456789012345</i>
Suffix Message	<i>[blank]</i>
Enable Checkbox	<i>[Checked]</i>

# 4G IIoT Gateway

## GNSS Setting

Go to **Service > Location Tracking > GNSS** Tab.

The GNSS allows user to set the configuration of GNSS, log NMEA data to storage, and send data to remote host. Ensure GNSS is enabled and saved

### Setup GNSS Configuration

Configuration	
Item	Setting
▶ GNSS	<input type="checkbox"/> Enable
▶ GNSS Type	GPS ▼
▶ GNSS Message Types	<input type="checkbox"/> GGA <input type="checkbox"/> GLL <input type="checkbox"/> GSA <input type="checkbox"/> GSV <input type="checkbox"/> RMC <input type="checkbox"/> VTG
▶ SBAS	<input checked="" type="checkbox"/> Enable
▶ Assisted GPS	<input checked="" type="checkbox"/> Enable 1 ▼ day Differential Almanac Corrections
▶ Data to Storage	<input type="checkbox"/> Enable    Select Device: Internal ▼ Interval: 5 (s) Data format: GPX ▼ Data file name: GPX_yyyyMMddhhmm Split file: <input type="checkbox"/> Enable    Size: 200 KB ▼ <input type="button" value="Download log file"/>

GNSS Configuration		
Item	Value setting	Description
<b>GNSS Enable</b>	The box is unchecked by default	Check <b>Enable</b> box to activate GNSS functions.
<b>GNSS Type</b>	<b>GPS</b> is selected by default	Select a <b>GNSS Type</b> (GNSS System) that you want to use. Please note this option is hardware dependent. The available options of GNSS type show on this page is according to product specification. You may not see all of these four options if your product doesn't support all of them.
<b>GNSS Message Types</b>	These box is unchecked by default.	Select one or more <b>GNSS Message Types</b> that you want to use for transmitting or recording GPS data. There are many sentences in the NMEA standard for selecting, <b>GGA, GLL, GSA, GSV, RMC</b> and <b>VTG</b> . <b>ALL Other</b> includes DTM, GNS, GRS, GST, ZDA, and GBS sentences. Only select the type you need, otherwise it will consume unnecessary network bandwidth. Note: The supported message type is hardware dependent.

# 4G IIoT Gateway

<b>SBAS</b>	The box is unchecked by default	Check <b>Enable</b> box to activate satellite-based augmentation system ( <b>SBAS</b> ). Note: Some devices do not support this function.
<b>Assisted GPS</b>	The box is checked by default	Check <b>Enable</b> box to activate Assisted GPS (A-GPS). Select the duration for downloading the <b>Differential Almanac Corrections</b> data from A-GPS server through IP network. Note: Some devices may not support this function.
<b>Data to Storage</b>	The box is unchecked by default	<ul style="list-style-type: none"> <li>● <b>Enable</b> (The box is unchecked by default) Check <b>Enable</b> box to activate data to storage function.</li> <li>● <b>Select Device</b> (A Must filled setting) Select <b>Internal</b> or <b>External</b> device to store log data.</li> <li>● <b>Interval</b> (A Must filled setting) Specify the time interval between two continuous data log. By default, 5 second is set. <i>Value Range: 5 ~ 60 seconds.</i></li> <li>● <b>Data Format</b> (A Must filled setting) Select data format (<b>RAW</b>, or <b>GPX</b>) to store.</li> <li>● <b>Data file name</b>(A Must filled setting) Define file name to store.</li> <li>● <b>Split Enable</b> Check <b>Enable</b> box to activate file splitting function.</li> <li>● <b>Split Size&amp; Unit</b> Define file size and unit for log file. By default, 200 KB is defined. <i>Value Range: &gt;= 10KB (Minimum file size is 10 KB).</i></li> <li>● <b>Download log file</b> Select a log file and Click <b>Download log file</b> to download through Web GUI. If the log format which is specified to download is GPX, we will convert standard GPX format for used.</li> </ul>
<b>Save</b>	NA	Click the <b>Save</b> button to save the configuration

## Create / Edit Remote Host

The Remote Host allows you to customize your rules for sending NMEA data to specific IP address and Port. The router supports up to a maximum of 10 rule sets.

Remote Host List <input type="button" value="Add"/> <input type="button" value="Delete"/>									
ID	Host Name	Host IP	Protocol Type	Port Number	Interval(s)	Prefix Message	Suffix Message	Enable	Actions

When **Add** button is applied, **Remote Host Configuration** screen will appear.

# 4G IIoT Gateway

Remote Host Configuration	
Item	Setting
▶ Host Name	<input type="text"/>
▶ Host IP	<input type="text"/>
▶ Protocol Type	TCP ▼
▶ Port Number	<input type="text"/>
▶ Interval(s)	<input type="text" value="1"/>
▶ Prefix Message	<input type="text"/>
▶ Suffix Message	<input type="text"/>
▶ Enable	<input type="checkbox"/>

Remote Host Configuration		
Item	Value setting	Description
<b>Host Name</b>	String format: any text	Enter the host name for the designated remote host. <b>Value Range:</b> -1 ~ 64 characters.
<b>Host IP</b>	A Must filled setting	Specify the <b>IP Address</b> of remote host. It will be use as destination IP for sending NMEA packets.
<b>Protocol Type</b>	TCP is selected by default	Specify the <b>Protocol (TCP or UDP)</b> to use for sending NMEA packets.
<b>Port Number</b>	A Must filled setting	Specify a <b>Port Number</b> as destination port for sending NMEA packets. <b>Value Range:</b> 1 ~ 65535.
<b>Interval(s)</b>	A Must filled setting	Specify the time <b>interval</b> (seconds) between two NMEA packets. <b>Value Range:</b> 1 ~255 seconds.
<b>Prefix Message</b>	String format: any text	Specify optional prefix string with specific information if your backend server can recognize. For example, you can input the IMEI code of this device here, and then your backend server can recognize this GPS data is sent from this device. You can also leave this field blank.
<b>Suffix Message</b>	String format: any text	Specify optional suffix string with specific information if your backend server can recognize.
<b>Enable</b>	The box is unchecked by default	Check <b>Enable</b> box to activate this remote host rule.
<b>Save</b>	NA	Click the <b>Save</b> button to save the configuration

## Chapter 8 Status

### 8.1 Dashboard

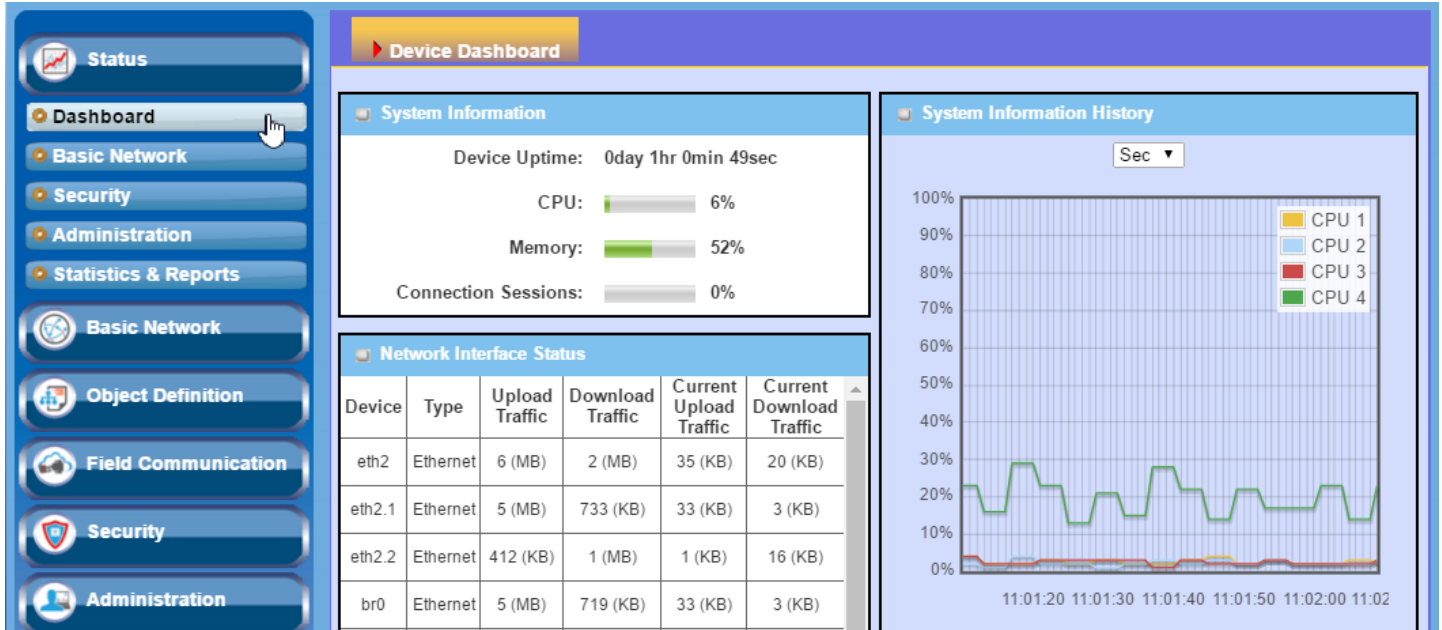

#### 8.1.1 Device Dashboard

The **Device Dashboard** window shows the current status in graph or tables for quickly understanding the operation status for the gateway. They are the System Information, System Information History, and Network Interface Status. The display will be refreshed once per second.

From the menu on the left, select **Status > Dashboard > Device Dashboard** tab.

#### System Information Status

The **System Information** screen shows the device Up-time and the resource utilization for the CPU, Memory, and Connection Sessions.

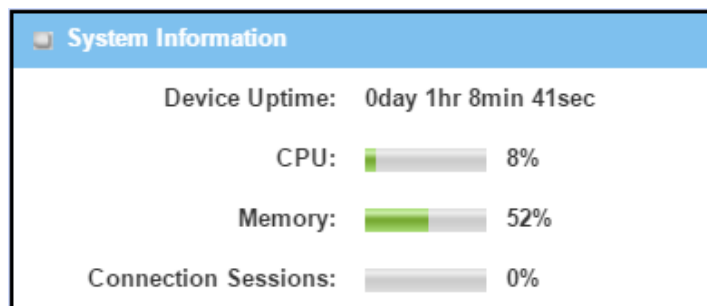

# 4G IIoT Gateway

## System Information History

The **System Information History** screen shows the statistic graphs for the CPU and memory.

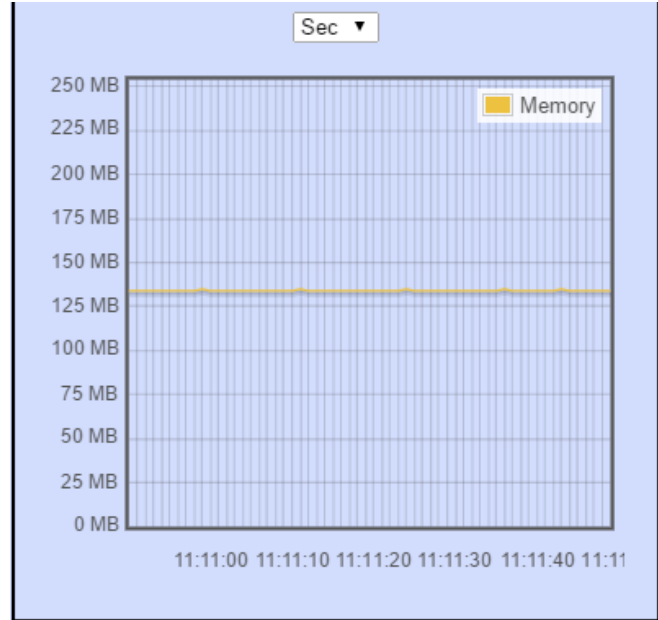
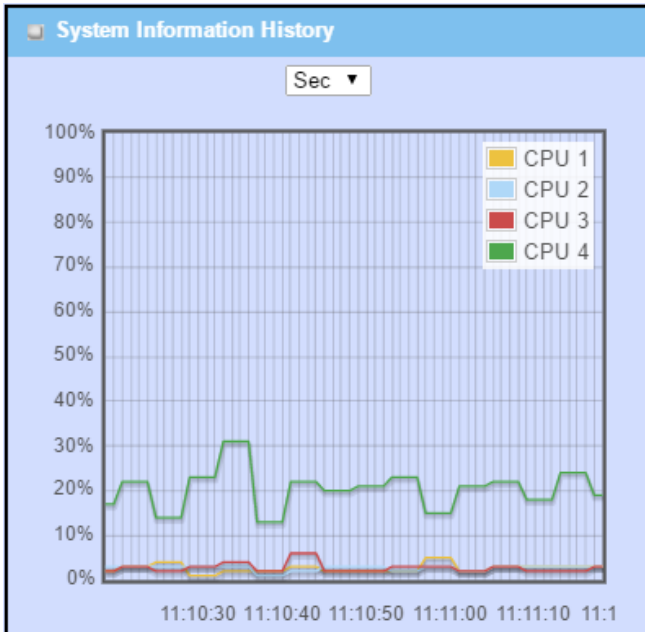

## Network Interface Status

The **Network Interface Status** screen shows the statistic information for each network interface of the gateway. The statistic information includes the Interface Type, Upload Traffic, Download Traffic, and Current Upload / Download Traffic.

Device	Type	Upload Traffic	Download Traffic	Current Upload Traffic	Current Download Traffic
eth2	Ethernet	27 (MB)	15 (MB)	35 (KB)	19 (KB)
eth2.1	Ethernet	26 (MB)	2 (MB)	34 (KB)	3 (KB)
eth2.2	Ethernet	1 (MB)	12 (MB)	1 (KB)	15 (KB)
br0	Ethernet	26 (MB)	2 (MB)	33 (KB)	3 (KB)
ra0	Wireless LAN	0 (Bytes)	0 (Bytes)	0 (Bytes)	0 (Bytes)
rai0	Wireless LAN	0 (Bytes)	0 (Bytes)	0 (Bytes)	0 (Bytes)
ra7	Wireless LAN	0 (Bytes)	0 (Bytes)	0 (Bytes)	0 (Bytes)
	Wireless				

# 4G IIoT Gateway

## 8.2 Basic Network

### 8.2.1 WAN & Uplink Status

Go to **Status > Basic Network > WAN & Uplink** tab.

The **WAN & Uplink Status** window shows the current status for different network type, including network configuration, connecting information, modem status and traffic statistics. The display will be refreshed on every five seconds.

#### WAN interface IPv4 Network Status

WAN interface IPv4 Network Status screen shows status information for IPv4 network.

WAN Interface IPv4 Network Status										
ID	Interface	WAN Type	Network Type	IP Addr.	Subnet Mask	Gateway	DNS	MAC Address	Conn. Status	Action
WAN-1	3G/4G	3G/4G	NAT	0.0.0.0	0.0.0.0	0.0.0.0	0.0.0.0, 0.0.0.0	N/A	Disconnected	<a href="#">Edit</a>
WAN-2		Disable								<a href="#">Edit</a>

WAN interface IPv4 Network Status		
Item	Value setting	Description
<b>ID</b>	N/A	It displays corresponding WAN interface WAN IDs.
<b>Interface</b>	N/A	It displays the type of WAN physical interface. Depending on the model purchased, it can be Ethernet, 3G/4G, etc...
<b>WAN Type</b>	N/A	It displays the method which public IP address is obtained from your ISP. Depending on the model purchased, it can be Static IP, Dynamic IP, PPPoE, PPTP, L2TP, 3G/4G.
<b>Network Type</b>	N/A	It displays the network type for the WAN interface(s). Depending on the model purchased, it can be NAT, Routing, Bridge, or IP Pass-through.
<b>IP Addr.</b>	N/A	It displays the public IP address obtained from your ISP for Internet connection. Default value is 0.0.0.0 if left unconfigured.
<b>Subnet Mask</b>	N/A	It displays the Subnet Mask for public IP address obtained from your ISP for Internet connection. Default value is 0.0.0.0 if left unconfigured.
<b>Gateway</b>	N/A	It displays the Gateway IP address obtained from your ISP for Internet connection. Default value is 0.0.0.0 if left unconfigured.
<b>DNS</b>	N/A	It displays the IP address of DNS server obtained from your ISP for Internet connection. Default value is 0.0.0.0 if left unconfigured.
<b>MAC Address</b>	N/A	It displays the MAC Address for your ISP to allow you for Internet access. Note: Not all ISP may require this field.
<b>Conn. Status</b>	N/A	It displays the connection status of the device to your ISP.

# 4G IIoT Gateway

		Status are Connected or disconnected.
		This area provides functional buttons.
		<b>Renew</b> button allows user to force the device to request an IP address from the DHCP server. Note: <b>Renew</b> button is available when DHCP WAN Type is used and WAN connection is disconnected.
		<b>Release</b> button allows user to force the device to clear its IP address setting to disconnect from DHCP server. Note: <b>Release</b> button is available when DHCP WAN Type is used and WAN connection is connected.
<b>Action</b>	N/A	<p><b>Connect</b> button allows user to manually connect the device to the Internet. Note: Connect button is available when Connection Control in WAN Type setting is set to Connect Manually (Refer to <b>Edit</b> button in <b>Basic Network &gt; WAN &amp; Uplink &gt; Internet Setup</b>) and WAN connection status is disconnected.</p> <p><b>Disconnect</b> button allows user to manually disconnect the device from the Internet. Note: <b>Connect</b> button is available when Connection Control in WAN Type setting is set to Connect Manually (Refer to <b>Edit</b> button in <b>Basic Network &gt; WAN &amp; Uplink &gt; Internet Setup</b>) and WAN connection status is connected.</p>

## WAN interface IPv6 Network Status

WAN interface IPv6 Network Status screen shows status information for IPv6 network.

WAN Interface IPv6 Network Status						
ID	Interface	WAN Type	Link-local IP Address	Global IP Address	Conn. Status	Action
WAN-1	Ethernet	DHCPv6	fe80::250:18ff:fe16:1121	/64	Disconnected	Connect Edit

WAN interface IPv6 Network Status		
Item	Value setting	Description
<b>ID</b>	N/A	It displays corresponding WAN interface WAN IDs.
<b>Interface</b>	N/A	It displays the type of WAN physical interface. Depending on the model purchased, it can be Ethernet, 3G/4G, etc...
<b>WAN Type</b>	N/A	It displays the method which public IP address is obtained from your ISP. WAN type setting can be changed from <b>Basic Network &gt; IPv6 &gt; Configuration</b> .
<b>Link-local IP Address</b>	N/A	It displays the LAN IPv6 Link-Local address.
<b>Global IP Address</b>	N/A	It displays the IPv6 global IP address assigned by your ISP for your Internet connection.
<b>Conn. Status</b>	N/A	It displays the connection status. The status can be connected, disconnected and connecting.
<b>Action</b>	N/A	This area provides functional buttons.

# 4G IIoT Gateway

**Edit Button** when pressed, web-based utility will take you to the IPv6 configuration page. (**Basic Network > IPv6 > Configuration.**)

## LAN Interface Network Status

**LAN Interface Network Status** screen shows IPv4 and IPv6 information of LAN network.

LAN Interface Network Status					
IPv4 Address	IPv4 Subnet Mask	IPv6 Link-Local Address	IPv6 Global Address	MAC Address	Action
192.168.123.254	255.255.255.0	fe80::250:18ff:fe00:ffe	/64	00:50:18:00:0F:FE	<input type="button" value="Edit IPv4"/> <input type="button" value="Edit IPv6"/>

LAN Interface Network Status		
Item	Value setting	Description
<b>IPv4 Address</b>	N/A	It displays the current IPv4 IP Address of the gateway This is also the IP Address user use to access Router's Web-based Utility.
<b>IPv4 Subnet Mask</b>	N/A	It displays the current mask of the subnet.
<b>IPv6 Link-Local Address</b>	N/A	It displays the current LAN IPv6 Link-Local address. This is also the IPv6 IP Address user use to access Router's Web-based Utility.
<b>IPv6 Global Address</b>	N/A	It displays the current IPv6 global IP address assigned by your ISP for your Internet connection.
<b>MAC Address</b>	N/A	It displays the LAN MAC Address of the gateway
<b>Action</b>	N/A	This area provides functional buttons. <b>Edit IPv4 Button</b> when press, web-based utility will take you to the Ethernet LAN configuration page. ( <b>Basic Network &gt; LAN &amp; VLAN &gt; Ethernet LAN</b> tab). <b>Edit IPv6 Button</b> when press, web-based utility will take you to the IPv6 configuration page. ( <b>Basic Network &gt; IPv6 &gt; Configuration.</b> )

## 3G/4G Modem Status

**3G/4G Modem Status List** screen shows status information for 3G/4G WAN network(s).

3G/4G Modem Status List <input type="button" value="Refresh"/>					
Interface	Card Information	Link Status	Signal Strength	Network Name	Action
3G/4G	ME3620-J	Disconnected	N/A		<input type="button" value="Detail"/>

3G/4G Modem Status List		
Item	Value setting	Description
<b>Physical Interface</b>	N/A	It displays the type of WAN physical interface. Note: Some device model may support two 3G/4G modules. Their physical interface

# 4G IIoT Gateway

		name will be <b>3G/4G-1</b> and <b>3G/4G-2</b> .
<b>Card Information</b>	N/A	It displays the vendor's 3G/4G modem model name.
<b>Link Status</b>	N/A	It displays the 3G/4G connection status. The status can be Connecting, Connected, Disconnecting, and Disconnected.
<b>Signal Strength</b>	N/A	It displays the 3G/4G wireless signal level.
<b>Network Name</b>	N/A	It displays the name of the service network carrier.
<b>Refresh</b>	N/A	Click the <b>Refresh</b> button to renew the information.
<b>Action</b>	N/A	This area provides functional buttons. <b>Detail Button</b> when press, windows of detail information will appear. They are the Modem Information, SIM Status, and Service Information. Refer to next page for more.

When the **Detail** button is pressed, 3G/4G modem information windows such as Modem Information, SIM Status, Service Information, Signal Strength / Quality, and Error Message will appear.

## Interface Traffic Statistics

Interface Traffic Statistics screen displays the Interface's total transmitted packets.

Interface Traffic Statistics			
ID	Interface	Received Packets(Mb)	Transmitted Packets(Mb)
WAN-1	3G/4G	0	0
WAN-2		-	-

Interface Traffic Statistics		
Item	Value setting	Description
<b>ID</b>	N/A	It displays corresponding WAN interface WAN IDs.
<b>Interface</b>	N/A	It displays the type of WAN physical interface. Depending on the model purchased, it can be Ethernet, 3G/4G, etc...
<b>Received Packets (Mb)</b>	N/A	It displays the downstream packets (Mb). It is reset when the device is rebooted.
<b>Transmitted Packets (Mb)</b>	N/A	It displays the upstream packets (Mb). It is reset when the device is rebooted.

# 4G IIoT Gateway

## 8.2.2 LAN & VLAN Status

Go to **Status > Basic Network > LAN & VLAN** tab.

### Client List

The **Client List** shows you the LAN Interface, IP address, Host Name, MAC Address, and Remaining Lease Time of each device that is connected to this gateway.

LAN Client List				
LAN Interface	IP Address	Host Name	MAC Address	Remaining Lease Time
Ethernet	Dynamic / 192.168.1.100	amit-25611230-1	00-01-0A-10-0F-17	23:59:51

LAN Client List		
Item	Value setting	Description
LAN Interface	N/A	Client record of LAN Interface. String Format.
IP Address	N/A	Client record of IP Address Type and the IP Address. Type is String Format and the IP Address is IPv4 Format.
Host Name	N/A	Client record of Host Name. String Format.
MAC Address	N/A	Client record of MAC Address. MAC Address Format.
Remaining Lease Time	N/A	Client record of Remaining Lease Time. Time Format.

# 4G IIoT Gateway

## 8.2.3 DDNS Status

Go to **Status > Basic Network > DDNS** tab.

The **DDNS Status** window shows the current DDNS service in use, the last update status, and the last update time to the DDNS service server.

### DDNS Status

DDNS Status List				
Host Name	Provider	Effective IP	Last Update Status	Last Update Time

DDNS Status		
Item	Value Setting	Description
Host Name	N/A	It displays the name you entered to identify DDNS service provider
Provider	N/A	It displays the DDNS server of DDNS service provider
Effective IP	N/A	It displays the public IP address of the device updated to the DDNS server
Last Update Status	N/A	It displays whether the last update of the device public IP address to the DDNS server has been successful (Ok) or failed (Fail).
Last Update Time	N/A	It displays time stamp of the last update of public IP address to the DDNS server.
Refresh	N/A	The <b>refresh</b> button allows user to force the display to refresh information.

# 4G IIoT Gateway

## 8.3 Security

The screenshot shows the 'VPN Firewall' status page. The sidebar on the left contains navigation buttons for Status, Basic Network, Security, Administration, and Statistics & Reports. The main content area is divided into four sections, each with an 'Edit' button and a table:

- IPSec Tunnel Status**: Table with columns: Tunnel Name, Tunnel Scenario, Local Subnets, Remote IP/FQDN, Remote.
- OpenVPN Server Status**: Table with columns: User Name, Remote IP/FQDN, Virtual IP/Mac.
- OpenVPN Client Status**: Table with columns: OpenVPN Client Name, Interface, Remote IP/FQDN, Remote Subnet, TUN/TAP Read(bytes), TUN/TAP Write(bytes), TCP/UDP Read(b).
- L2TP Server Status**: Table with columns: User Name, Remote IP, Remote Virtual IP, Remote.

### 8.3.1 VPN Status

Go to **Status > Security > VPN** tab.

The **VPN Status** window shows the overall VPN tunnel status. The display will be refreshed on every five seconds.

#### IPSec Tunnel Status

**IPSec Tunnel Status** windows show the configuration for establishing IPSec VPN connection and current connection status.

IPSec Tunnel Status						
<a href="#">Edit</a>						
Tunnel Name	Tunnel Scenario	Local Subnets	Remote IP/FQDN	Remote Subnets	Conn. Time	Status

IPSec Tunnel Status		
Item	Value setting	Description
<b>Tunnel Name</b>	N/A	It displays the tunnel name you have entered to identify.
<b>Tunnel Scenario</b>	N/A	It displays the Tunnel Scenario specified.
<b>Local Subnets</b>	N/A	It displays the Local Subnets specified.
<b>Remote IP/FQDN</b>	N/A	It displays the Remote IP/FQDN specified.
<b>Remote Subnets</b>	N/A	It displays the Remote Subnets specified.
<b>Conn. Time</b>	N/A	It displays the connection time for the IPSec tunnel.
<b>Status</b>	N/A	It displays the Status of the VPN connection. The status displays are Connected, Disconnected, Wait for traffic, and Connecting.

# 4G IIoT Gateway

<b>Edit Button</b>	N/A	Click on Edit Button to change IPSec setting, web-based utility will take you to the IPSec configuration page. ( <b>Security &gt; VPN &gt; IPSec</b> tab)
--------------------	-----	-----------------------------------------------------------------------------------------------------------------------------------------------------------

## OpenVPN Server Status

According to OpenVPN configuration, the **OpenVPN Server/Client Status** shows the status and statistics for the OpenVPN connection from the server side or client side.

OpenVPN Server Status		Edit		
User Name	Remote IP/FQDN	Virtual IP/Mac	Conn. Time	Status
OpenVPN Server Status				
Item	Value setting	Description		
<b>User Name</b>	N/A	It displays the Client name you have entered for identification.		
<b>Remote IP/FQDN</b>	N/A	It displays the public IP address (the WAN IP address) of the connected OpenVPN Client		
<b>Virtual IP/MAC</b>	N/A	It displays the virtual IP/MAC address assigned to the connected OpenVPN client.		
<b>Conn. Time</b>	N/A	It displays the connection time for the corresponding OpenVPN tunnel.		
<b>Status</b>	N/A	It displays the connection status of the corresponding OpenVPN tunnel. The status can be Connected, or Disconnected.		

## OpenVPN Client Status

OpenVPN Client Status										Edit
OpenVPN Client Name	Interface	Remote IP/FQDN	Remote Subnet	TUN/TAP Read(bytes)	TUN/TAP Write(bytes)	TCP/UDP Read(bytes)	TCP/UDP Write(bytes)	Conn. Time	Conn. Status	
OpenVPN Client Status										
Item	Value setting	Description								
<b>OpenVPN Client Name</b>	N/A	It displays the Client name you have entered for identification.								
<b>Interface</b>	N/A	It displays the WAN interface specified for the OpenVPN client connection.								
<b>Remote IP/FQDN</b>	N/A	It displays the peer OpenVPN Server's Public IP address (the WAN IP address) or FQDN.								
<b>Remote Subnet</b>	N/A	It displays the Remote Subnet specified.								
<b>TUN/TAP Read(bytes)</b>	N/A	It displays the TUN/TAP Read Bytes of OpenVPN Client.								
<b>TUN/TAP Write(bytes)</b>	N/A	It displays the TUN/TAP Write Bytes of OpenVPN Client.								
<b>TCP/UDP Read(bytes)</b>	N/A	It displays the TCP/UDP Read Bytes of OpenVPN Client.								
<b>TCP/UDP Write(bytes)</b>	N/A	It displays the TCP/UDP Write Bytes of OpenVPN Client. Connection								
<b>Conn. Time</b>	N/A	It displays the connection time for the corresponding OpenVPN tunnel.								
<b>Conn. Status</b>	N/A	It displays the connection status of the corresponding OpenVPN tunnel. The status can be Connected, or Disconnected.								

# 4G IIoT Gateway

## L2TP Server/Client Status

L2TP Server/Client Status shows the configuration for establishing L2TP tunnel and current connection status.

L2TP Server Status <span>Edit</span>					
User Name	Remote IP	Remote Virtual IP	Remote Call ID	Conn. Time	Status

L2TP Server Status		
Item	Value setting	Description
User Name	N/A	It displays the login name of the user used for the connection.
Remote IP	N/A	It displays the public IP address (the WAN IP address) of the connected L2TP client.
Remote Virtual IP	N/A	It displays the IP address assigned to the connected L2TP client.
Remote Call ID	N/A	It displays the L2TP client Call ID.
Conn. Time	N/A	It displays the connection time for the L2TP tunnel.
Status	N/A	It displays the Status of each of the L2TP client connection. The status displays Connected, Disconnect, Connecting
Edit	N/A	Click on <b>Edit</b> Button to change L2TP server setting, web-based utility will take you to the L2TP server page. ( <b>Security &gt; VPN &gt; L2TP</b> tab)

L2TP Client Status <span>Edit</span>							
L2TP Client Name	Interface	Virtual IP	Remote IP/FQDN	Default Gateway/Remote Subnet	Conn. Time	Status	

L2TP Client Status		
Item	Value setting	Description
Client Name	N/A	It displays Name for the L2TP Client specified.
Interface	N/A	It displays the WAN interface with which the gateway will use to request PPTP tunneling connection to the PPTP server.
Virtual IP	N/A	It displays the IP address assigned by Virtual IP server of L2TP server.
Remote IP/FQDN	N/A	It displays the L2TP Server's Public IP address (the WAN IP address) or FQDN.
Default Gateway/Remote Subnet	N/A	It displays the specified IP address of the gateway device used to connect to the internet to connect to the L2TP server –the default gateway. Or other specified subnet if the default gateway is not used to connect to the L2TP server –the remote subnet.
Conn. Time	N/A	It displays the connection time for the L2TP tunnel.
Status	N/A	It displays the Status of the VPN connection. The status displays Connected, Disconnect, and Connecting.
Edit	N/A	Click on <b>Edit</b> Button to change L2TP client setting, web-based utility will take you to the L2TP client page. ( <b>Security &gt; VPN &gt; L2TP</b> tab)

# 4G IIoT Gateway

## PPTP Server/Client Status

PPTP Server/Client Status shows the configuration for establishing PPTP tunnel and current connection status.

PPTP Server Status <span>Edit</span>					
User Name	Remote IP	Remote Virtual IP	Remote Call ID	Conn. Time	Status
<b>PPTP Server Status</b>					
Item	Value setting	Description			
User Name	N/A	It displays the login name of the user used for the connection.			
Remote IP	N/A	It displays the public IP address (the WAN IP address) of the connected PPTP client.			
Remote Virtual IP	N/A	It displays the IP address assigned to the connected PPTP client.			
Remote Call ID	N/A	It displays the PPTP client Call ID.			
Conn. Time	N/A	It displays the connection time for the PPTP tunnel.			
Status	N/A	It displays the Status of each of the PPTP client connection. The status displays Connected, Disconnect, and Connecting.			
Edit Button	N/A	Click on <b>Edit</b> Button to change PPTP server setting, web-based utility will take you to the PPTP server page. ( <b>Security &gt; VPN &gt; PPTP</b> tab)			

PPTP Client Status <span>Edit</span>						
PPTP Client Name	Interface	Virtual IP	Remote IP/FQDN	Default Gateway/Remote Subnet	Conn. Time	Status
<b>PPTP Client Status</b>						
Item	Value setting	Description				
Client Name	N/A	It displays Name for the PPTP Client specified.				
Interface	N/A	It displays the WAN interface with which the gateway will use to request PPTP tunneling connection to the PPTP server.				
Virtual IP	N/A	It displays the IP address assigned by Virtual IP server of PPTP server.				
Remote IP/FQDN	N/A	It displays the PPTP Server's Public IP address (the WAN IP address) or FQDN.				
Default Gateway / Remote Subnet	N/A	It displays the specified IP address of the gateway device used to connect to the internet to connect to the PPTP server –the default gateway. Or other specified subnet if the default gateway is not used to connect to the PPTP server –the remote subnet.				
Conn. Time	N/A	It displays the connection time for the PPTP tunnel.				
Status	N/A	It displays the Status of the VPN connection. The status displays Connected, Disconnect, and Connecting.				
Edit Button	N/A	Click on <b>Edit</b> Button to change PPTP client setting, web-based utility will take you to the PPTP server page. ( <b>Security &gt; VPN &gt; PPTP</b> tab)				

# 4G IIoT Gateway

## 8.3.2 Firewall Status

Go to **Status > Security > Firewall Status** Tab.

The **Firewall Status** provides user a quick view of the firewall status and current firewall settings. It also keeps the log history of the dropped packets by the firewall rule policies, and includes the administrator remote login settings specified in the Firewall Options. The display will be refreshed on every five seconds.

By clicking the icon [+], the status table will be expanded to display log history. Clicking the **Edit** button the screen will be switched to the configuration page.

### Packet Filter Status

Packet Filters <span>Edit</span> <span>[+]</span>			
Activated Filter Rule	Detected Contents	IP	Time

Packet Filter Status		
Item	Value setting	Description
Activated Filter Rule	N/A	This is the Packet Filter Rule name.
Detected Contents	N/A	This is the logged packet information, including the source IP, destination IP, protocol, and destination port –the TCP or UDP. String format: Source IP to Destination IP : Destination Protocol (TCP or UDP)
IP	N/A	The Source IP (IPv4) of the logged packet.
Time	N/A	The Date and Time stamp of the logged packet. Date & time format. ("Month" "Day" "Hours":"Minutes":"Seconds")

*Note: Ensure Packet Filter Log Alert is enabled.*

*Refer to **Security > Firewall > Packet Filter** tab. Check Log Alert and save the setting.*

### MAC Control Status

MAC Control <span>Edit</span> <span>[+]</span>			
Activated Control Rule	Blocked MAC Addresses	IP	Time

MAC Control Status		
Item	Value setting	Description
Activated Control Rule	N/A	This is the MAC Control Rule name.

# 4G IIoT Gateway

<b>Blocked MAC Addresses</b>	N/A	This is the MAC address of the logged packet.
<b>IP</b>	N/A	The Source IP (IPv4) of the logged packet.
<b>Time</b>	N/A	The Date and Time stamp of the logged packet. Date & time format. ("Month" "Day" "Hours":"Minutes":"Seconds")

Note: Ensure MAC Control Log Alert is enabled.

Refer to **Security > Firewall > MAC Control** tab. Check Log Alert and save the setting.

## IPS Status

<span>IPS</span> <span>Edit</span> <span>[ + ]</span>		
Detected Intrusion	IP	Time

IPS Firewall Status		
Item	Value setting	Description
<b>Detected Intrusion</b>	N/A	This is the intrusion type of the packets being blocked.
<b>IP</b>	N/A	The Source IP (IPv4) of the logged packet.
<b>Time</b>	N/A	The Date and Time stamp of the logged packet. Date & time format. ("Month" "Day" "Hours":"Minutes":"Seconds")

Note: Ensure IPS Log Alert is enabled.

Refer to **Security > Firewall > IPS** tab. Check Log Alert and save the setting.

## Firewall Options Status

<span>Options</span> <span>Edit</span> <span>[ + ]</span>			
Stealth Mode	SPI	Discard Ping from WAN	Remote Administrator Management

Firewall Options Status		
Item	Value setting	Description
<b>Stealth Mode</b>	N/A	Enable or Disable setting status of Stealth Mode on Firewall Options. String Format: Disable or Enable
<b>SPI</b>	N/A	Enable or Disable setting status of SPI on Firewall Options. String Format : Disable or Enable
<b>Discard Ping from WAN</b>	N/A	Enable or Disable setting status of Discard Ping from WAN on Firewall Options. String Format: Disable or Enable
<b>Remote Administrator Management</b>	N/A	Enable or Disable setting status of Remote Administrator. If Remote Administrator is enabled, it shows the currently logged in

## 4G IloT Gateway

---

administrator's source IP address and login user name and the login time.

Format:

IP : "Source IP", User Name: "Login User Name", Time: "Date time"

Example:

IP: 192.168.127.39, User Name: admin, Time: Mar 3 01:34:13

*Note: Ensure Firewall Options Log Alert is enabled.*

*Refer to **Security > Firewall > Options** tab. Check Log Alert and save the setting.*

# 4G IIoT Gateway

## 8.4 Administration

### 8.4.1 Configure & Manage Status

Go to **Status > Administration > Configure & Manage** tab.

The **Configure & Manage Status** window shows the status for managing remote network devices. The type of management available in your device is depended on the device model purchased. The commonly used ones are the SNMP and UPnP. The display will be refreshed on every five seconds.

#### SNMP Linking Status

**SNMP Link Status** screen shows the status of current active SNMP connections.

SNMP Linking Status						
User Name	IP Address	Port	Community	Auth. Mode	Privacy Mode	SNMP Version

SNMP Link Status		
Item	Value setting	Description
User Name	N/A	It displays the user name for authentication. This is only available for SNMP version 3.
IP Address	N/A	It displays the IP address of SNMP manager.
Port	N/A	It displays the port number used to maintain connection with the SNMP manager.
Community	N/A	It displays the community for SNMP version 1 or version 2c only.
Auth. Mode	N/A	It displays the authentication method for SNMP version 3 only.
Privacy Mode	N/A	It displays the privacy mode for version 3 only.
SNMP Version	N/A	It displays the SNMP Version employed.

#### SNMP Trap Information

**SNMP Trap Information** screen shows the status of current received SNMP traps.

SNMP Trap Information		
Trap Level	Time	Trap Event

SNMP Trap Information		
Item	Value setting	Description
Trap Level	N/A	It displays the trap level.
Time	N/A	It displays the timestamp of trap event.
Trap Event	N/A	It displays the IP address of the trap sender and event type.

# 4G IIoT Gateway

---

## 8.4.2 Log Storage Status

Go to **Status > Administration > Log Storage** tab.

The **Log Storage Status** screen shows the status for selected device storage.

### Log Storage Status

**Log Storage Status** screen shows the status of current the selected device storage. The status includes Device Description, Usage, File System, Speed, and status.

Storage Information				
Device Description	Usage	File System	Speed	Status
Internal Storage	2 / 8192 KB	JFFS2	N/A	Ready

# 4G IIoT Gateway

## 8.4.3 GNSS Status

Go to **Status > Administration > GNSS** tab.

The **GNSS Information** screen shows the status for current GNSS positioning information for the gateway.

GNSS Information						
Condition	No. of Satellites	Satellites ID / Signal Strength (dBm)	Position (Lat, Long)	Altitude (meters)	True Course	Ground Speed (km/h)
Not Fixed						

The available GNSS information includes GNSS Condition, No. of Satellites, Satellites ID / Signal Strength, Position (Lat., Long.), Altitude (meters), True Course, and the equivalent Ground Speed (km/h).

## 8.5 Statistics & Report

The screenshot displays the 'Connection Session' tab in the 4G IIoT Gateway web interface. The sidebar on the left contains navigation options: Status, Dashboard, Basic Network, Security, Administration, Statistics & Reports, and Basic Network. The main content area shows a table titled 'Internet Surfing List (1 entries)' with the following data:

User Name	Protocol	Internal IP & Port	MAC	External IP & Port	Duration Time
	TCP	192.168.1.100:54729		192.168.1.1:80	2016/12/20 04:23~

### 8.5.1 Connection Session

Go to **Status > Statistics & Reports > Connection Session** tab.

**Internet Surfing Statistic** shows the connection tracks on this router.

The screenshot displays the 'Internet Surfing List (33 entries)' table in the web interface. The table has the following data:

User Name	Protocol	Internal IP & Port	MAC	External IP & Port	Duration Time
	UDP	192.168.123.100:51736		192.168.123.254:53	2017/03/22 03:43~
	UDP	192.168.123.100:55986		192.168.123.254:53	2017/03/22 03:43~
	UDP	192.168.123.100:49548		192.168.123.254:53	2017/03/22 03:43~
	UDP	192.168.123.100:60969		192.168.123.254:53	2017/03/22 03:43~
	UDP	192.168.123.100:56053		192.168.123.254:53	2017/03/22 03:43~

Item	Value setting	Description
<b>Previous</b>	N/A	Click the <b>Previous</b> button; you will see the previous page of track list.
<b>Next</b>	N/A	Click the <b>Next</b> button; you will see the next page of track list.
<b>First</b>	N/A	Click the <b>First</b> button; you will see the first page of track list.
<b>Last</b>	N/A	Click the <b>Last</b> button; you will see the last page of track list.
<b>Export (.xml)</b>	N/A	Click the <b>Export (.xml)</b> button to export the list to xml file.
<b>Export (.csv)</b>	N/A	Click the <b>Export (.csv)</b> button to export the list to csv file.
<b>Refresh</b>	N/A	Click the <b>Refresh</b> button to refresh the list.

# 4G IIoT Gateway

## 8.5.2 Network Traffic

Go to **Status > Statistics & Reports > Network Traffic** tab.

**Network Traffic Statistics** screen shows the historical graph for the selected network interface.

You can change the interface drop list and select the interface and sampling time interval you want to monitor.

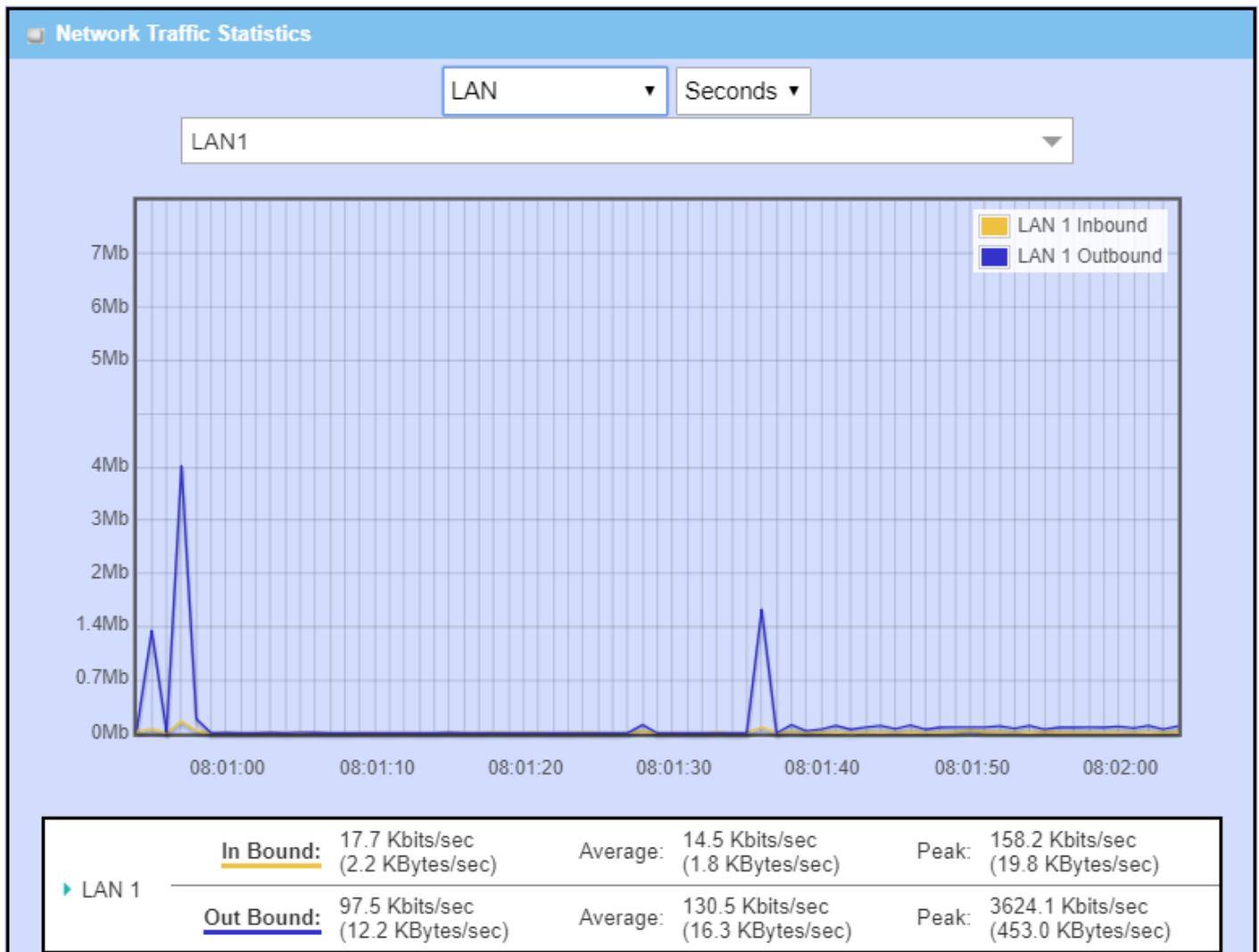

# 4G IIoT Gateway

## 8.5.3 Device Administration

Go to **Status > Statistics & Reports > Device Administration** tab.

**Device Administration** shows the login information.

Device Manager Login Statistics				
Previous				
Next				
First				
Last				
Export (.xml)				
Export (.csv)				
Refresh				
User Name	Protocol Type	IP Address	User Level	Duration Time
admin	http/https	192.168.123.100	Admin	2017/03/22 03:31~

Device Manager Login Statistic		
Item	Value setting	Description
<b>Previous</b>	N/A	Click the <b>Previous</b> button; you will see the previous page of login statistics.
<b>Next</b>	N/A	Click the <b>Next</b> button; you will see the next page of login statistics.
<b>First</b>	N/A	Click the <b>First</b> button; you will see the first page of login statistics.
<b>Last</b>	N/A	Click the <b>Last</b> button; you will see the last page of login statistics.
<b>Export (.xml)</b>	N/A	Click the <b>Export (.xml)</b> button to export the login statistics to xml file.
<b>Export (.csv)</b>	N/A	Click the <b>Export (.csv)</b> button to export the login statistics to csv file.
<b>Refresh</b>	N/A	Click the <b>Refresh</b> button to refresh the login statistics.

# 4G IIoT Gateway

---

## 8.5.4 Cellular Usage

Go to **Status > Statistics & Reports > Cellular Usage** tab.

**Cellular Usage** screen shows data usage statistics for the selected cellular interface. The cellular data usage can be accumulated per hour or per day.

